

List of Materials

MODELS: BREEZE I - AK1124x, AK1100x, AK1136x
BREEZE II - AK1200x, AK1236x

PARTS SUPPLIED

- 1 - Hood
- 2 - Aluminum mesh filters
- 2 - Halogen light bulbs (GU-10, 35W) (pre-installed)
- 1 - 3-1/4" x 10" rectangular starting collar with damper (located inside hood body)
- 1 - Hardware package



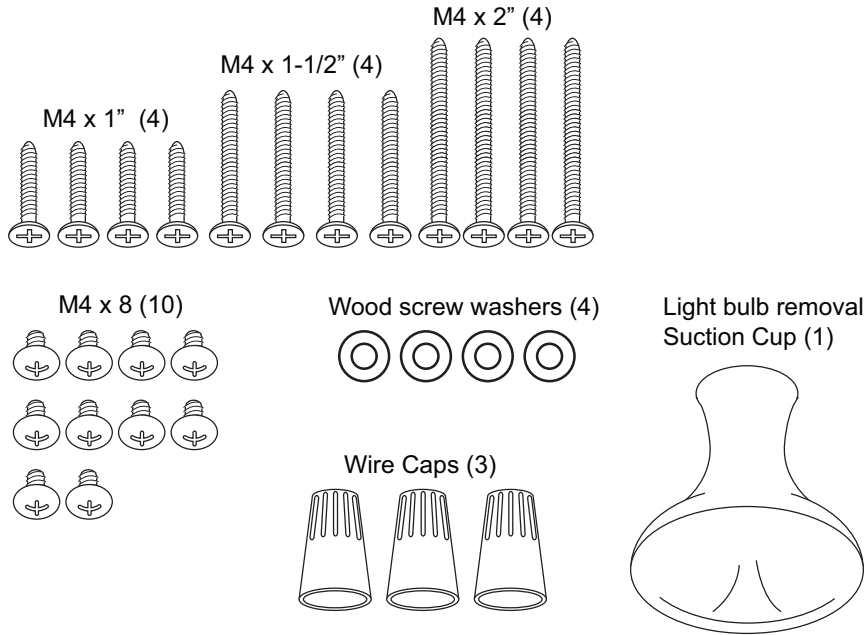







HARDWARE PACKAGE CONTENTS

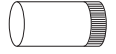
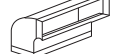





PARTS NOT SUPPLIED

- Ducting, conduit and all installation tools
- Cable connector (*if required by local codes*)
- Recirculating Kit (0AK11-21001)

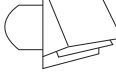
Installation – Ducting Calculation Sheet

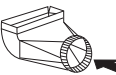
Duct pieces		Equivalent number length x used =	Total
	3-1/4" x 10" Rect., straight	1 Ft. x () =	Ft.
	6" Round, straight	1 Ft. x () =	Ft.
	7"-10" Round, straight	1 Ft. x () =	Ft.
	3-1/4" x 10" Rect. 90° elbow	15 Ft. x () =	Ft.
	3-1/4" x 10" Rect. 45° elbow	9 Ft. x () =	Ft.
	3-1/4" x 10" Rect. 90° flat elbow	24 Ft. x () =	Ft.
	3-1/4" x 10" Rect. wall cap with damper	30 Ft. x () =	Ft.
	3-1/4" x 10" Rect. to 6" round transition	5 Ft. x () =	Ft.
	3-1/4" x 10" Rect. to 6" round transition 90° elbow	20 Ft. x () =	Ft.
	6" Round, 90° elbow	15 Ft. x () =	Ft.
	6" Round, 45° elbow	9 Ft. x () =	Ft.
Subtotal column 1 =			Ft.

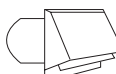
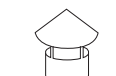
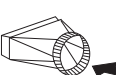
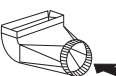
Duct pieces		Equivalent number length x used =	Total
	6" Round wall cap with damper	30 Ft. x () =	Ft.
	6" Round, roof cap	30 Ft. x () =	Ft.
	6" round to 3-1/4" x 10" rect. transition	1 Ft. x () =	Ft.
	6" round to 3-1/4" x 10" rect. transition 90° elbow	16 Ft. x () =	Ft.
	7" - 10" Round, 90° elbow	15 Ft. x () =	Ft.
	7" - 10" Round, 45° elbow	9 Ft. x () =	Ft.
	7" - 10" Round wall cap with damper	30 Ft. x () =	Ft.
	7" - 10" Round, roof cap	30 Ft. x () =	Ft.
	7" round to 3 1/4" x 10" rect. transition	8 Ft. x () =	Ft.
	7" round to 3-1/4" x 10" rect. transition 90° elbow	23 Ft. x () =	Ft.
Subtotal column 2 =			Ft.
Subtotal column 1 =			Ft.
Total ductwork =			Ft.

Maximum Duct Length: For satisfactory air movement, the total duct length should not exceed 100 equivalent feet.

Installation – Mounting Height & Clearance

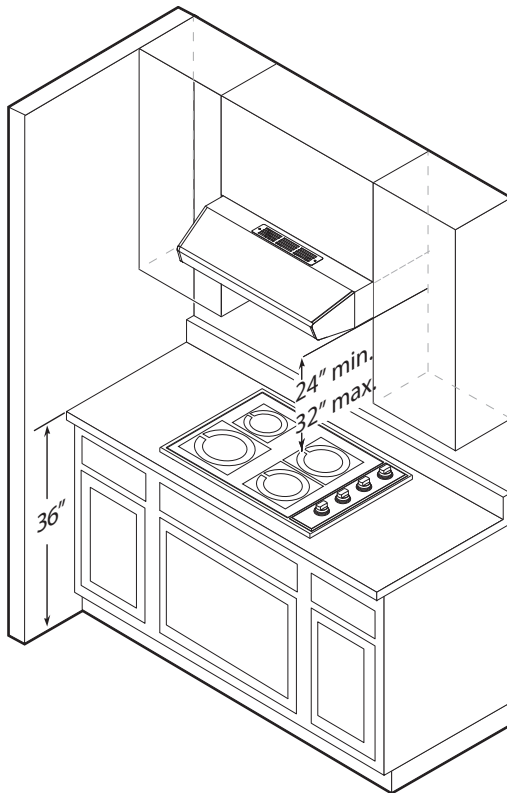

Minimum mount height between range top to hood bottom should be no less than 24".

Maximum mount height should be no higher than 32".

It is important to install the hood at the proper mounting height. Hoods mounted too low could result in heat damage and fire hazard; while hoods mounted too high will be hard to reach and will lose its performance and efficiency.

If available, also refer range manufacturer's height clearance requirements and recommended hood mounting height above range.

DUCTING

A minimum 3-1/4" x 10" rectangular duct must be used to maintain maximum air flow efficiency.

Always use rigid type metal ducts only. Flexible ducts could restrict air flow by up to 50%.

Also use calculation (on page 5) to compute total available duct run when using elbows, transitions and caps.

ALWAYS, when possible, reduce the number or transitions and turns. If long duct run is required, increase duct size.

If turns or transitions are required; install as far away from hood duct output and as far apart, between the two as possible.

Vertical Ducting:

3-1/4"x10" minimum

Horizontal Ducting:

3-1/4"x10" minimum

DAMAGE-SHIPMENT / INSTALLATION:

- Please fully inspect unit for damage before installation.
- If the unit is damaged in shipment, return the unit to the store in which it was bought for repair or replacement.
- If the unit is damaged by the customer, repair or replacement is the responsibility of the customer.
- If the unit is damaged by the installer (if other than the customer), repair or replacement must be made by arrangement between customer and installer.