

Dishwasher
Lave-Vaisselle



BOSCH

en Operating instructions
fr Guide d'Utilisation

9001124245 (9511)

Dear Valued Customer,

Thank you for selecting a Bosch® dishwasher. You have joined the many consumers who demand quiet and superior performance from their dishwashers.

This manual was written with your safety and convenience in mind, and the information contained herein is very important. We highly recommend that you read this manual before using your dishwasher for the first time.

To learn more about your dishwasher and available accessories, as well as many other top quality Bosch® appliances, visit our web site at:

www.bosch-home.com/us (USA)

or

www.bosch-home.ca (Canada)

While there, don't forget to register your new dishwasher by clicking on the "Support" tab or filling out the product registration card enclosed with your new unit.

If you have any questions or comments, please contact us by phone at:
1-800-944-2904

or write us at:

BSH Home Appliances Corporation
1901 Main Street, Suite 600
Irvine, CA 92614

Table of Contents

IMPORTANT SAFETY INSTRUCTIONS	2
Dishwasher Components	4
Dishwasher Features	5
Loading the Dishwasher	6
Loading the Silverware Basket	8
Rack Accessories	10
Adding Detergent and Rinse Agent	10
Dishwasher Cycles and Options	12
Wash Cycle Information	13
Operating the Dishwasher	13
Care and Maintenance	15
Troubleshooting	16
Customer Service	18
Warranty Information	20

IMPORTANT SAFETY INSTRUCTIONS: **Please READ and SAVE this information**

WARNING

Misuse of the dishwasher can result in serious injury or death. Do not use the dishwasher in any way not covered in this manual or for any purpose other than those explained in the following pages.



Severe product damage and/or injury could result from the use of unqualified service technicians or non-original replacement parts. All repairs must be performed by a qualified service technician using only original equipment factory replacement parts.



Electrical shock or fire could result if the electrical supply for the dishwasher covered in this manual is incorrectly installed or if the dishwasher has been improperly grounded. Do not use the dishwasher covered in this manual unless you are certain the electrical supply has been correctly installed and the dishwasher has been properly grounded.



Never use harsh chemicals to clean your dishwasher. Some chloride-containing products can damage your dishwasher and may present health hazards!



To avoid risk of injury (burn), always use caution when opening the door during or following a wash cycle as hot water or steam may escape. Do not fully open the door until water noises have stopped and steam has subsided..

NOTICE

Never use steam cleaning products to clean your dishwasher. The manufacturer will not be responsible for the possible damages or consequences.



It is highly recommended for the end user to become familiar with the procedure to shut off the incoming water supply and the procedure to shut off the incoming power supply. See the Installation Instructions or contact your installer for more information.



To avoid possible dishwasher damage, do not use harsh chemicals, abrasive cleaners, scouring pads (metal or plastic), or abrasive cloths/paper towels to clean your dishwasher's exterior door panel. Your dishwasher's exterior door panel can be damaged by doing so.



NSF/ANSI 184 Certified residential dishwashers are not intended for licensed food establishments.



WARNING: To reduce the risk of fire, electrical shock, or serious injury, observe the following:

- 1 This dishwasher is provided with Installation Instructions and this Use and Care Manual (operating instructions). Read and understand all instructions before using the dishwasher.
- 2 This appliance must be grounded to a metal, permanent wiring system, or an equipment grounding conductor must be run with the circuit conductors and connected to the equipment grounding terminal or lead on the dishwasher. See the Installation Instructions included with this dishwasher for more information on electrical requirements.
- 3 Use this dishwasher only for its intended function, which is the washing of household dishware and kitchenware rated as dishwasher safe.
- 4 Use only detergents or rinsing agents recommended for use in a dishwasher, and keep them out of the reach of children.
- 5 When loading items to be washed:
 - Locate sharp items so they are not likely to damage the door seal.
 - Load knives and other sharp utensils with their HANDLES UP to reduce the risk of cut-type injuries.
 - Do not wash plastic items unless they are marked “dishwasher safe” or the equivalent. For plastic items not so marked, check the manufacturer’s recommendations.
 - Do not operate your dishwasher unless all enclosure panels are in place.
 - Do not tamper with or override controls and interlocks.
- 6 Do not abuse, sit or stand on the door or dish racks of the dishwasher.
- 7 To reduce risk of injury, do not allow children to play in or on the dishwasher.
- 8 When children become old enough to operate the appliance, it is the responsibility of the parents/legal guardians to ensure the children are instructed in safe practices by qualified persons.
- 9 Under certain conditions, hydrogen gas may be produced in a hot water system that has not been used for two weeks or more. Hydrogen gas is explosive. Before using a dishwasher that is connected to a hot water system that has been unused for two weeks or longer, turn on all hot water faucets and let the water flow from each for several minutes. This will release any accumulated hydrogen gas. As the gas is explosive, do not smoke or use an open flame during this time.
- 10 Remove the dishwasher door to the washing compartment when removing an old dishwasher for service or discarding.
- 11 To avoid floor damage and possible mold growth, do not allow wet areas to remain around or under the dishwasher.
- 12 Protect your dishwasher from the elements. Protect against freezing to avoid possible damage to the fill valve. Damage caused by freezing is not covered by the warranty.
- 13 This appliance must be grounded. In the event of a malfunction or breakdown, grounding will reduce the risk of electric shock by providing a path of least resistance for electric current. This appliance is equipped with a cord having an equipment-grounding conductor.
 - Improper connection of the equipment-grounding conductor can result in risk of electric shock. Check with a qualified electrician or service representative if you are in doubt whether the appliance is properly grounded.

State of California Proposition 65 Warnings:

WARNING: This product contains one or more chemicals known to the State of California to cause cancer, birth defects, or other reproductive harm.

Dishwasher Components

Wash Cycles								Additional Features					
Model	Heavy Wash	Auto Wash	Normal Wash	Delicate Wash	Express Wash	Half Load	Rinse & Hold	Adjustable Upper Rack	Child Lock	Delay Start	Flip Tines	Sanitize Option	Silverware Basket
SHE3AR7#UC* SHE3ARB#UC*	X	X	X	X	X	X		X	X	X	X	X	Long
SHE3ARF#UC*	X	X	X	X	X		X	X	X	X	X	X	Double-Flex™
SHX3AR7#UC*	X	X	X	X	X	X		X		X	X	X	Double-Flex™

* “#” can be any number

SHE3AR7#UC*/SHE3ARB#UC*

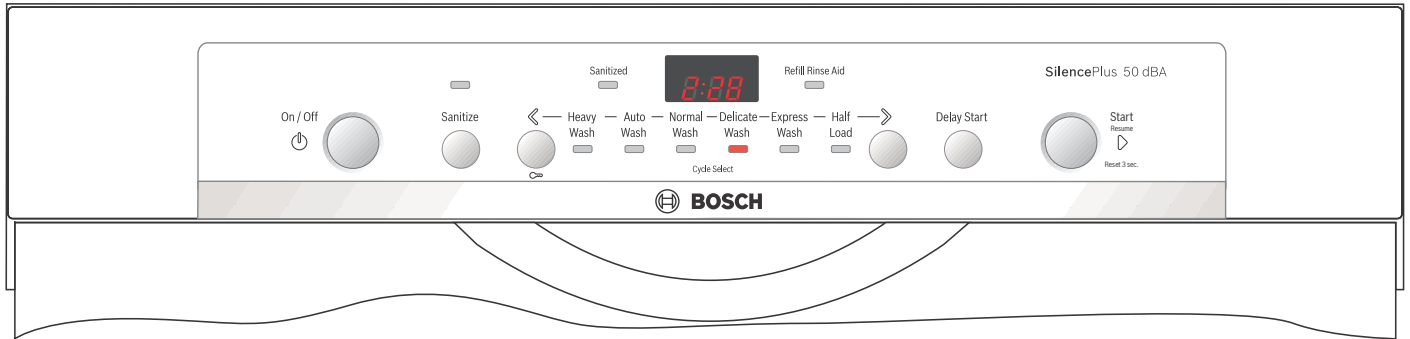

SHE3ARF#UC*

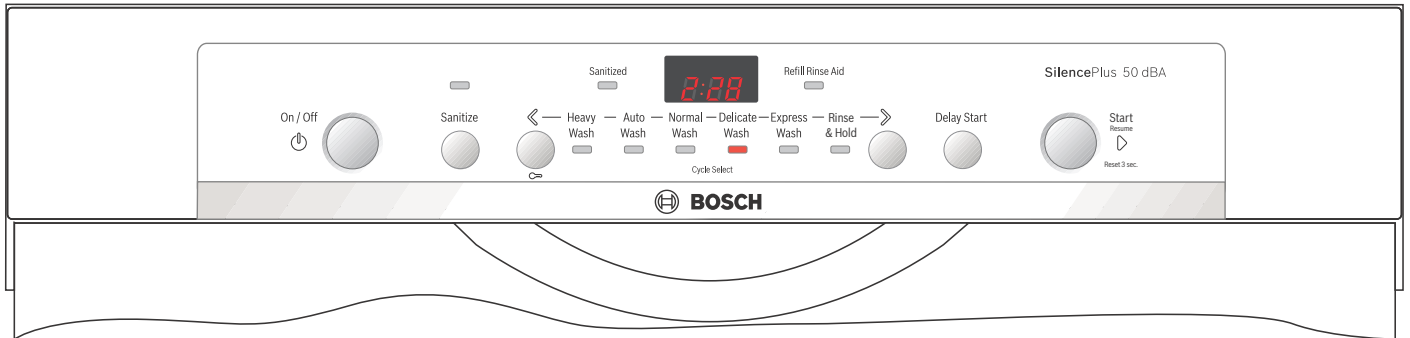

SHX3AR7#UC*

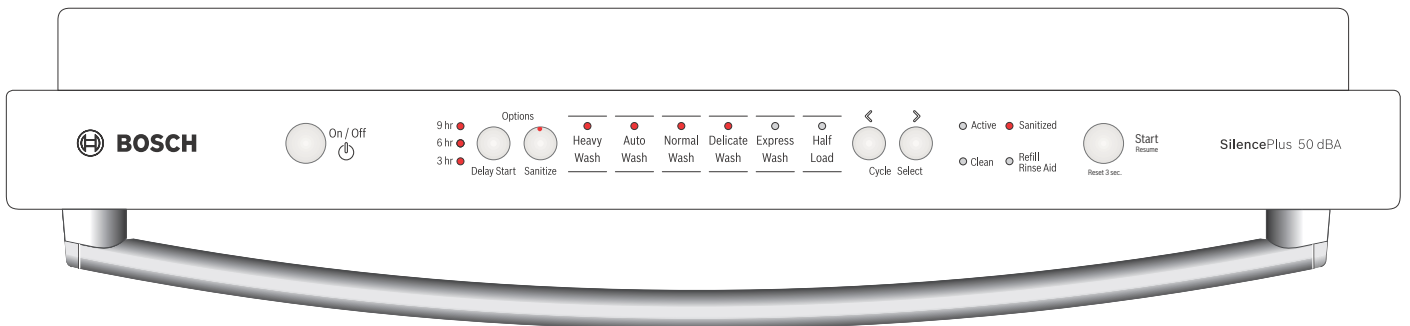

* “#” can be any number

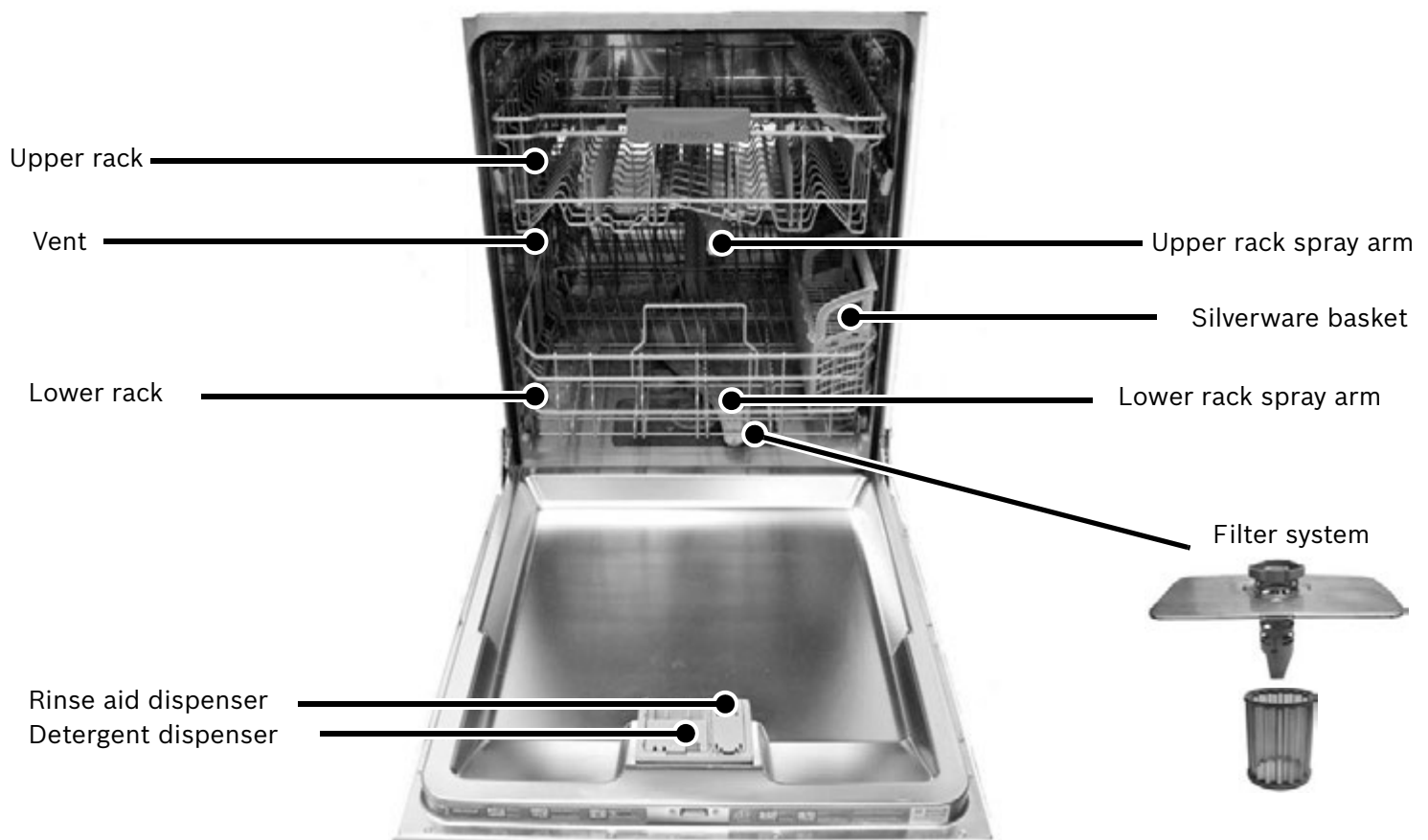

Dishwasher Features

Self-Latching Door: The self-latching feature will hold the door wherever you place it and then automatically latch when open 20 degrees or less.

Delay Start: Delays the start time of your dishwasher by 3, 6, or 9 hours.

EcoSense Wash Management System: Checks water condition and decides if a second fresh water fill is necessary.

Extra Dry Heat: Raises the temperature of the rinse and increases the drying time resulting in improved drying.

Flow-Through Heater™: Quickly and efficiently heats water to a sanitizing temperature.

Noise Reduction System: Uses Suspension Motor™, a two-pump motor system, and insulation to make this dishwasher part of the quietest dishwasher line in North America.

Nylon Coated Racks: Eliminates cuts and nicks and have a five year warranty.

OptiDry®: This feature senses when the unit is low on rinse agent and automatically increases the drying time.

Sanitize: An option to meet sanitized conditions and improve drying results. This option can only be used with certain wash cycles. See page 12.

Triple Filtration System: Uses multiple filters to ensure distribution of clean water and protect the main pump and the drain pump from foreign material.

Model dependent features:

Adjustable Rack: The upper rack can be raised or lowered manually to accommodate tall items in the upper and lower racks.

Flip Tines: Increase the rack flexibility to accommodate larger/taller items.

Dishware Materials

NOTE: Before using your dishwasher for the first time, check the information in this section. Some items are not dishwasher safe and should be hand washed; others require special loading.

Recommended:

Aluminum: Colored anodized aluminum may fade over time. Minerals in your water may cause the aluminum to darken or spot. This can usually be removed with a soap-filled steel wool pad.

China, Crystal, Stoneware: Some hand-painted utensils may discolor, fade or spot. Hand wash these utensils. Position fragile glassware so that it will not topple over or come in contact with other utensils during the wash cycle.

Glass: Milk glasses may discolor or become yellow.

Non-stick Coatings: Apply a light coating of vegetable oil to non-stick surfaces after drying.

Plastics: Make sure the plasticware is dishwasher safe.

Stainless Steel, Sterling Silver and Silver Plates: Load these so they do not come in contact with other metals.

Not Recommended:

Acrylic: Cracking or small cracks throughout the acrylic, may occur.

Adhesive-Joined Pieces: Adhesives that join materials such as plastic, wood, bone, steel copper, tin, etc. may loosen.

Bone-Handled Utensils: Handles may separate.

Iron: Iron will rust. Hand wash and dry immediately.

Non-Dishware Items: Your dishwasher is intended for use in cleaning ONLY standard household dishware and kitchenware.

Pewter, Brass, Bronze: These items will tarnish. Hand wash and dry immediately.

Tin: Tin will stain. Hand wash and dry immediately.

Wood: Wooden bowls, wooden utensils and utensils with wooden handles can crack, warp and lose their finish.

Loading the Dishwasher

Do not pre-wash items with loosely attached soiling. Remove all food particles, bones, toothpicks and excessive grease. Items having burned-on, baked-on or starchy soils may require some pretreatment. Refer to the Dishware Materials section for more information about dishware suitability.

Load only dishwasher safe items into the dishwasher. Load dishes in the dishwasher racks so the insides of bowls, pots and pans are facing the spray arms. Avoid nesting and contact points between dishes. Separate items of dissimilar metals.



WARNING

The sharp points and edges of knives and other sharp utensils can cause serious injuries. Load knives and other sharp utensils with edges down. Do not allow children to handle or play near knives and sharp utensils.

NOTICE

To avoid dishwasher damage, do not load the dishwasher with paper products, plastic bags, packing materials or anything other than normal, dishwasher safe dishware and kitchenware.

Loading the Upper Rack

Ensure items do not protrude through the bottom of the racks and block the spray arms.

NOTE: When pushing the upper rack into the dishwasher, push it until it stops against the back of the tub so the upper rack spray arm connects to the water supply at the back of the tub. Do not push racks in using the door.

Loading the Lower Rack

Place large items in the lower rack. Load pots, pans and bowls upside down. Do not block vent with tall baking sheets. Load these items on the left side of the dishwasher.

Unloading the Dishwasher

When unloading the dishwasher it is best to unload the lower rack first. Next, unload the silverware basket followed by the upper rack.

Suggested Loading Pattern

Upper Rack



Lower Rack



Additional Loading Pattern

Upper Rack

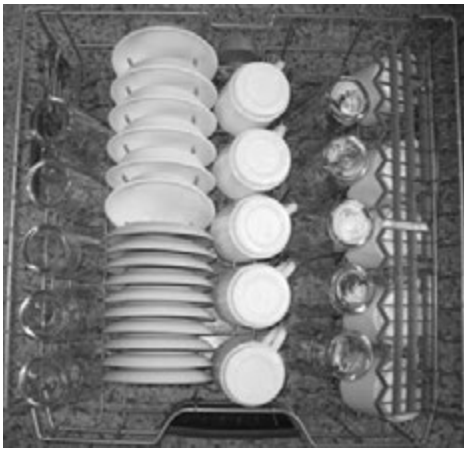

Lower Rack

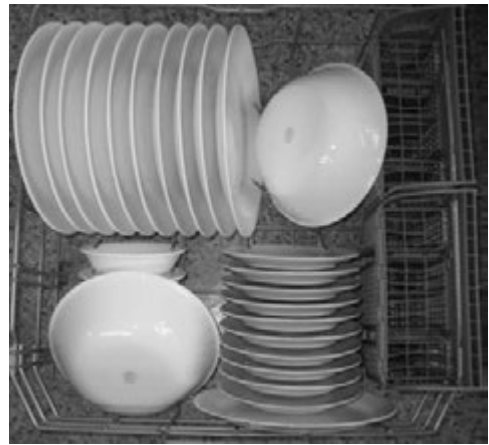

Loading the Silverware Basket

Place knives and sharp utensils with their HANDLES UP and forks and spoons with their handles down. If large or oddly-shaped items are loaded in the silverware basket, be sure they do not nest together.

WARNING

The sharp points and edges of knives and other sharp utensils can cause serious injury. Load knives and other sharp utensils with edges down. Do not allow children to handle or play near knives and sharp utensils.

The Double-Flex™ Silverware Basket (select models)

This basket splits along its length, resulting in two halves that may be placed in a variety of positions in the lower rack, greatly increasing the lower rack's loading versatility. The basket snaps together either back to back or end to end as shown.

To split the Double-Flex™ Silverware Basket

Grasp the basket and slide the two halves in opposite directions as shown at right and then pull the two halves apart.

Double-Flex™ Basket Placement Options



The Long Silverware Basket (select models)

The long silverware basket fits along the side of the lower rack.

Long Basket Placement Option



The basket lid may also be snapped to the handle in order to leave the basket open.

Loading pattern for Long Silverware Basket

- 1- salad fork 5 - tablespoon
- 2- teaspoon 6 - serving spoon
- 3- dinner fork 7 - serving fork
- 4- knife

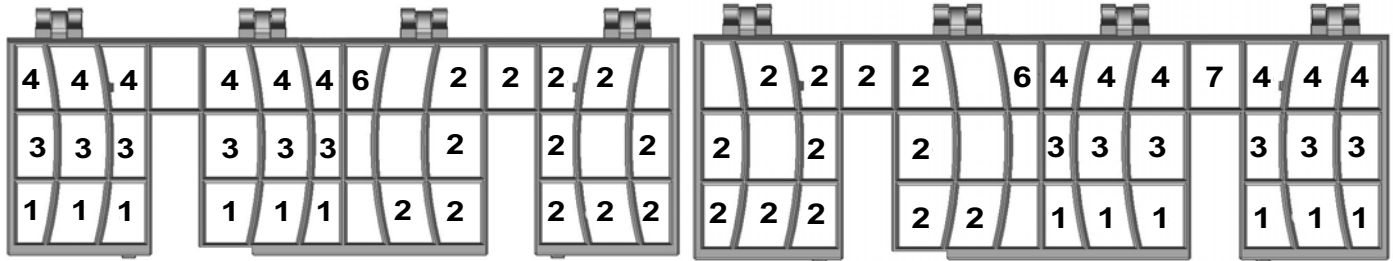
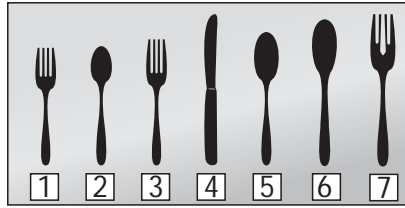

Loading pattern for Double-Flex™ Silverware Basket

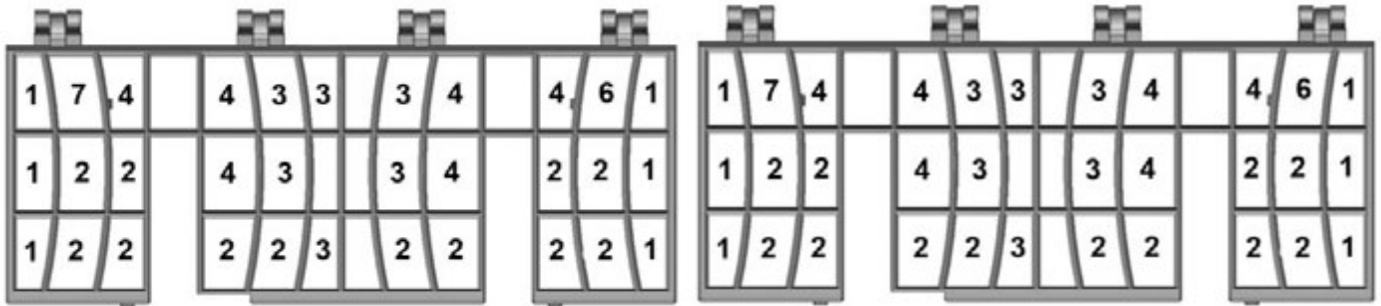

Rack Accessories

Flip Tines (model dependent)

The racks consist of tines that can be folded down depending on what you may need to load in the rack. To fold down, grasp the folding tine and release from notch. Push folding tine downward to desired position as shown in **Figure 1**.

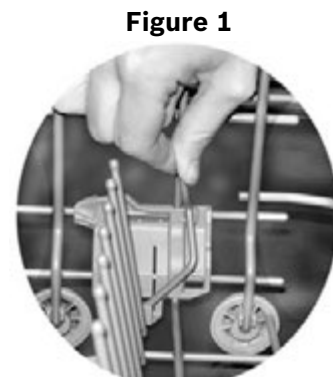

Figure 2

Adjustable Upper Rack (model dependent)

Remove the empty upper rack by pulling it out of the dishwasher until it can be lifted upward as show in **Figure 2**. Pull the rack up and out until the rollers are completely free of the roller guides.



Figure 3

Re-insert the rack with the other set of rollers on the roller guides as shown in **Figure 3**.



Adding Detergent and Rinse Agent

Detergent

Use only detergent specifically designed for dishwashers. For best results, use fresh powdered dishwashing detergent or detergent tabs.

NOTICE

To avoid dishwasher damage, do not use hand dishwashing products in your dishwasher.

To avoid dishwasher damage, do not use too much detergent if your water is soft. Using too much detergent with soft water may cause etching in glassware.

This dishwasher uses less water than most, therefore, less detergent is required. With soft water, 1 tablespoon (15 ml) of detergent will clean most loads. The detergent dispenser cup has lines that measure detergent to 1 tablespoon (15 ml) and 1.75 tablespoons (25 ml). 3 tablespoons (45 ml) of detergent will completely fill the detergent dispenser.

NOTE: If you do not know the hardness of your water supply, use 15ml of detergent. Increase the amount if necessary to the least amount required to get your kitchenware clean.

Use the measuring lines in the detergent dispenser cup as a guide to measure the amount of detergent recommended in **Table 1** on page 11.

Adding Detergent

- 1 tablespoon (15ml) will clean most loads (see **Figure 4**).
- Do not use more than 3 tablespoons (45ml).
- Do not over fill the detergent dispenser.
- When using detergent tabs, lay them flat to avoid contact with the cover.

To Close

- Place finger as shown in **Figure 5**.
- Slide door closed and press down firmly until it clicks.

To Open

- To open the cover, push the button as shown in **Figure 6**.
- Cover will slide open.

Table 1 - Recommended Detergent Amount

Wash Cycle	Hard Water/ Heavy Soil	Medium Water/ Medium Soil	Soft Water/ Little Soil
Heavy	3 tbsp (45 ml)	3 tbsp (45 ml)	1.75-3 tbsp (25-45 ml)
Auto	1.75-3 tbsp (25-45 ml)	1.75 tbsp (25 ml)	1-1.75 tbsp (15-25 ml)
Normal	1.75-3 tbsp (25-45 ml)	1.75 tbsp (25 ml)	1-1.75 tbsp (15-25 ml)
Delicate	1.75 tbsp (25 ml)	1-1.75 tbsp (15-25 ml)	1 tbsp (15 ml)
Express	1.75 tbsp (25 ml)	1-1.75 tbsp (15-25 ml)	1 tbsp (15 ml)
Half Load	1.75 tbsp (25 ml)	1-1.75 tbsp (15-25 ml)	1 tbsp (15 ml)
Rinse & Hold	None	None	None

Figure 4

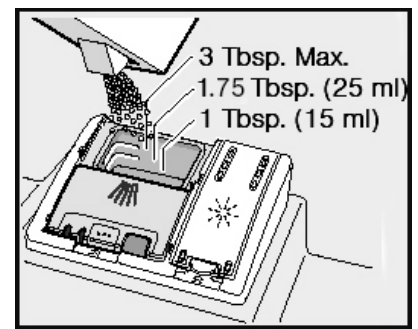

Figure 5

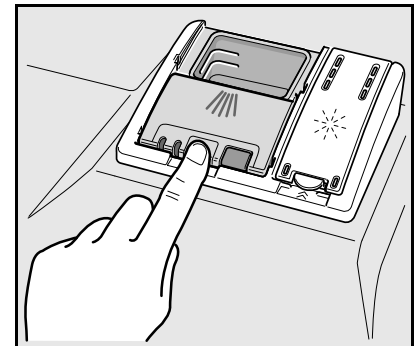

Figure 6

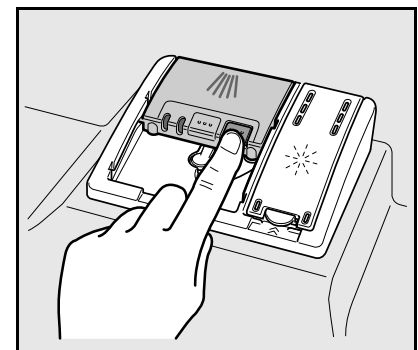
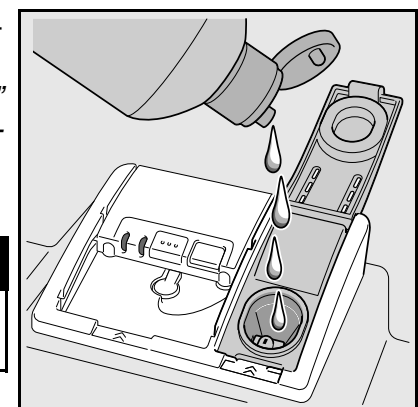

Figure 7



Rinse Aid

To achieve proper drying, always use a liquid rinse aid, even if your detergent contains a rinse aid or drying additive.

NOTE: The dishwasher indicates low rinse aid by turning on the “Refill Rinse Aid” LED in the display. If this light is on, you need to refill the rinse aid dispenser by following the directions below.

Adding Rinse Aid

NOTICE

To avoid oversudsing or clogging, do not overfill the rinse aid dispenser. Wipe up any spills with a damp cloth.

- 1 Add liquid rinse aid to the dispenser until it is full (see **Figure 7**). Do not overfill.
- 2 Close the lid. **Lid must be fully closed until it clicks in order to seal.**
- 3 Wipe up any excess rinse aid that may have puddled when the dispenser reservoir is full.

The indicator light will go out a few moments after the dishwasher door is shut. See page 14 for instructions on how to adjust the amount of rinse aid dispensed.

Dishwasher Cycles and Options

Wash Cycles (model dependent)

NOTE: In order to save energy, it is recommended to set the “Auto Power Off” feature to “P:01” (see manual section titled “Auto Power Off”).

Heavy Wash: Best for cleaning items with baked-on food or grease. These dishes would normally require soaking.

Auto Wash: With our most complex soil sensing capability, this cycle is perfect for use with mixed loads of dishware and varying amounts of food soil. This is the most flexible cycle and is a good choice for everyday use.

Normal: The Normal cycle is recommended for daily, regular, or typical use to completely wash a full load of normally soiled dishes.

In order to obtain optimal performance with minimum energy consumption, it is recommended to disable all available features as noted at the start of this section.

NOTE 1: See footnote for additional energy test setup instructions.

Delicate Wash: For delicate or heirloom dishware and silverware or other special items. Always make sure that the items are dishwasher safe. Refer to the Dishware Materials section on page 6 of this manual for further information. Hand washing may be the best treatment for “Not Recommended” items.

Express Wash: Cleans lightly soiled dishes and reduces overall wash time. Use this cycle to clean glasses and dessert dishware that may need to be reused at the same event.

Half Load: Can reduce the energy and water consumption when washing small, lightly soiled loads that fill approximately half of the dishwasher’s capacity.

Rinse & Hold: Allows you to rinse food soil off of a partial load and hold them in the dishwasher until you are ready to run a full load.

Wash Cycle Options

Delay Start: Allows you to delay the start time of your dishwasher by 3, 6, or 9 hours.

Sanitize: The Sanitize feature is available only in the Heavy, Auto, Normal and Half Load cycles. Select one of these cycles, press the “Sanitize Option” button and then press Start to activate the Sanitation features. The sanitize LED will light when sanitation requirements are met. The technical sanitation measures may also improve the drying results.

NOTE: The dishwasher automatically defaults to Auto Wash when turned off and back on. If you used the sanitize option in your last cycle, the dishwasher will default to Auto Wash with the Sanitize option selected when you turn it on.

NOTE 1: The Energy Guide label was based on the Normal or Regular soil sensing cycle as follows: The unit was tested without any Rinse Aid (liquid) in the Rinse Aid chamber. A single dose of detergent was inserted into the Detergent Dispenser, with no detergent being used in the prewash. The unit was not subjected to truncated testing per the definitions in the test procedure. We recommend that dish loads such as the one in the energy certification test have the rack position set in the highest position.

Wash Cycle Information

NOTE: To save energy, this dishwasher has a “Smart Control” where the sensors in the dishwasher automatically adjust the cycle length, temperature and water changes based on the amount of food soil and the incoming water temperature. The “Smart Control” makes decisions that can cause the cycle time and water usage to adjust intermittently. Wash cycle times are based on 120°F water supply. If your household water supply is different than 120°F, your dishwasher’s cycle times may be impacted.

Table 2 - Wash Cycle Information

	Heavy Wash	Auto Wash	Normal Wash	Delicate Wash	Express Wash	Half Load	Rinse & Hold
cycle time	110-130 min	115-130 min	130-135 min	80-85 min	30	95-115 min	12 min
cycle time with Sanitize	120-140 min	135-150 min	150-155 min	not available	not available	115-135 min	not available
water consumption	20.4-26.6 L 5.4-7 gal	13.8-23.2 L 3.6-6.1 gal	10.9-20.7 L 2.9-5.5 gal	9.9-15.1 L 2.6-4 gal	12.2 L 3.2 gal	10.5-16.3 L 2.8-4.3 gal	4.1 L 1.1 gal
wash temperature	66-71°C 151-160°F	55-66°C 130-150°F	50-55°C 122-131°F	45-50°C 113-122°F	48°C 118°F	52°C 126°F	not available
rinse temperature	72°C 162°F	68-72°C 154-162°F	67-70°C 153-158°F	62°C 144°F	55°C 131°F	68-72°C 154-162°F	incoming

NOTE: Only sanitizing cycles have been designed to meet the requirements of Section 6 of the NSF/ANSI Standard for Residential Equipment for soil removal and sanitization efficacy. There is no intention, either directly or indirectly, to imply that all cycles have passed sanitization performance tests.

Operating the Dishwasher

Start the Dishwasher

- 1 Press the **On/Off** button.
- 2 One of the wash cycle LEDs will be flashing. You can now select a wash cycle.
- 3 Press the **Cycle Select** arrow buttons to select the desired wash cycle.
- 4 Press **Start** to begin the cycle.

NOTE: Your dishwasher is protected against unintentional operation. If the appliance door remains open for more than 4 seconds after pressing the [Start/Resume] button, the operation will be paused. Press the [Start/Resume] button again and close the appliance door.

Delay Start

- 1 Press the **On/Off** button.
- 2 Select a cycle.
- 3 Press and hold the **Delay Start** button until the desired delay time is shown in the display window or the appropriate LED is lit (depending on model).
- 4 Press **Start** to begin the cycle.

NOTE: Your dishwasher is protected against unintentional operation. If the appliance door remains open for more than 4 seconds after pressing the [Start/Resume] button, the operation will be paused. Press the [Start/Resume] button again and close the appliance door.

Cancel a Cycle

- 1 Press and hold **Start** for 3 seconds.
- 2 Wait about 1 minute until the display reads “0:00” (models with display) or the “Clean” LED illuminates (models without display), indicating it is done draining.
- 3 Press the **On/Off** button. You may now start a new cycle.

NOTE: Your dishwasher is protected against unintentional operation. If the appliance door remains open for more than 4 seconds after pressing the [Start/Resume] button, the operation will be paused. Press the [Start/Resume] button again and close the appliance door.

Child Lock

NOTE: Only front-control models have Child Lock.

- 1 After starting a cycle you can activate the Child Lock.
- 2 Press and hold the C button until the display reads “CL” (models with display) or the “Child Lock” LED illuminates (models without display). *NOTE: “CL” disappears from screen when button is released.*
- 3 Child Lock is now active and buttons will not function, except On/Off.
- 4 To deactivate, press and hold the C button until the “Child Lock” LED turns off or “CL” disappears from the display.

For Models with Display

To enter options mode:

- 1 Press the **On/Off** button to turn the unit on.
- 2 The countdown display and one of the wash cycle LEDs will be flashing.
- 3 Press and hold down the **>** button, then simultaneously press and release the **Start** button. Now release the **>** button.
- 4 The “Sanitized” LED will be flashing. You are now in options mode.
- 5 Press the **>** button to select the option you would like to adjust.

To set amount of Rinse Aid:

NOTE: If your glasses have spots on them, you need more rinse aid. If your glasses have streaks on them, you need less rinse aid.

- 1 Follow the above instructions to enter options mode.
- 2 With the display showing “r:00” - “r:06” press the **<** button to change the amount of rinse aid dispensed.
r:00 = rinse aid is OFF
r:03 = medium amount of rinse aid dispensed
r:06 = highest amount of rinse aid dispensed
- 3 Press **Start** to save your setting.

To turn Extra Dry Heat ON or OFF:

- 1 Follow the above instructions to enter options mode.
- 2 With the display showing “d:00” or “d:01” press the **<** button to turn Extra Dry Heat ON or OFF.
d:00 = Extra Dry Heat is OFF
d:01 = Extra Dry Heat is ON
- 3 Press **Start** to save your setting.

Auto Power Off

NOTE: Setting can only be changed for models with a display. For models without a display, the default setting is P:00

To save energy, the dishwasher is turned off 1 minute after the wash cycle ends. This setting can be adjusted from P:00 to P:02.

To change the setting:

- 1 Open the door and press the [On/Off] button.
- 2 Hold down the “A” button (see page 17) and press [Start] until the display indicates “d:0x” (x can be any number). Release both buttons.
- 3 Press the “A” button until the display indicates “P:0x”.
- 4 Press the “C” button until the display corresponds with your requirements.
P:00 = dishwasher does not turn off automatically
P:01 = dishwasher turns off automatically after 1 minute
P:02 = dishwasher turns off automatically after 120 minutes (2 hours)
- 5 Press [Start] to save the setting.

For Models without Display

To enter options mode:

- 1 Press the **On/Off** button to turn the unit on. For models with the buttons on top, the door must be open. For models with the buttons on the front, the door must be closed.
- 2 One of the wash cycle LEDs will be flashing.
- 3 Press and hold down the **>** button, then simultaneously press and release the **Start** button. Now release the **>** button.
- 4 The “Clean” and one other LED (varies by model) will be flashing. You are now in options mode.
- 5 Press the **>** button to select the option you would like to adjust.

To set amount of Rinse Aid:

NOTE: If your glasses have spots on them, you need more rinse aid. If your glasses have streaks on them, you need less rinse aid.

- 1 Follow the above instructions to enter options mode.
- 2 With the “Clean” and “Rinse Aid” LEDs flashing, press the **<** button to change the amount of rinse aid dispensed. The “Clean” and “Rinse Aid” LEDs keep flashing and:
0 wash cycle LEDs on = rinse aid is OFF
1 wash cycle LED on = lowest amount of rinse aid dispensed
2 wash cycle LEDs on = medium amount of rinse aid dispensed
3 wash cycle LEDs on = highest amount of rinse aid dispensed
- 3 Press **Start** to save your setting.

To turn Extra Dry Heat ON or OFF:

- 1 Follow the above instructions to enter options mode.
- 2 With the “Clean” and “Sanitized” LEDs flashing, press the **<** button to turn Extra Dry Heat ON or OFF. The “Clean” and “Sanitized” LEDs keep flashing and:
0 wash cycle LEDs on = Extra Dry Heat is OFF
1 wash cycle LED on = Extra Dry Heat is ON
- 3 Press **Start** to save your setting.

Care and Maintenance

Maintenance Tasks

Certain areas of the dishwasher require occasional maintenance. The maintenance tasks are easy to do and will ensure continued superior performance from your dishwasher.

Wiping up Spills and Splash-outs

Water may occasionally splash out of your dishwasher, particularly if you interrupt a cycle or open the dishwasher door during a cycle. To avoid floor damage and possibly mold growth, do not allow wet areas to remain around or under the dishwasher.

Clean the Stainless Steel Inner Door and Tub

Clean the outer edges of the inside door panel regularly to remove debris that may collect from normal loading. If spots begin to appear on the stainless steel, make sure the rinse agent is full and functioning properly.

Check and Clean Spray Arm Nozzles

Remove the upper spray arm by first removing the empty upper rack from the dishwasher. Turn the rack upside down. The upper spray arm is held in position by a locking nut as shown in **Figure 8**. Turn the locking nut counterclockwise and remove it to release the spray arm. Look for obstruction in the spray nozzles. If the spray nozzles need cleaning, flush them under running water.

To reinstall the upper spray arm, place it back in position and return the locking nut to its install position. Turn the locking nut clockwise to secure. Return the upper rack to the upper rack roller guides.

Remove the lower spray arm by first removing the empty lower rack from the dishwasher. Grasp and lift the spray arm as shown in **Figure 9**. Look for obstruction in the spray nozzles. If the spray nozzles need cleaning, flush them under running water.

To reinstall the lower spray arm, return the lower spray arm to the installed position and press it until it snaps into place. Return the lower rack to the installed position.

Figure 8

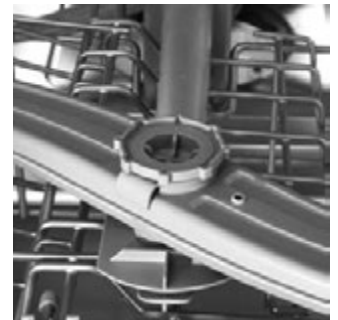

Figure 9



Check and Clean the Filter System

The filter system consists of a Large Object Trap, Fine Filter and a Micro Filter.

The filter system is located on the inside of your dishwasher under the lower rack and is easily accessible. During normal use, the filter system is self-cleaning. You should occasionally inspect it for foreign objects and clean it when necessary.

⚠ WARNING

Use caution when removing parts for cleaning as some debris may be sharp.

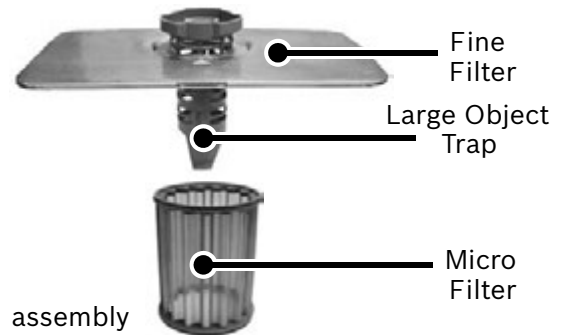

To remove the Large Object Trap, remove the lower rack. Grasp the assembly and turn it counterclockwise as shown in **Figure 10**. Lift the assembly out.

Carefully examine the assembly. If you find debris in the Large Object Trap, turn it upside-down and gently tap it on a flat surface to dislodge and remove debris.

Flush the Micro Filter clean by holding it under running water.

To reinstall the filter system, return the fine filter to the installed position. Turn the locking nut clockwise until it is locked. The arrow on the ring handle and the arrow on the Fine Filter should point at each other.

Figure 10

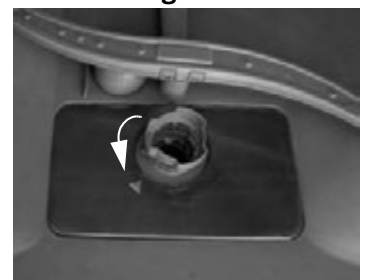

Clean the Exterior Door Panel

Colored doors: use only a soft cloth dampened with soapy water.

Stainless steel doors: use a soft cloth with a non-abrasive cleaner (preferably a liquid spray) made for cleaning stainless steel. For the best results, apply the stainless steel cleaner to the cloth and then wipe the surface.

Clean the Door Gasket

Regularly clean the door gasket with a damp cloth to remove food particles and other debris. Also clean the door seal, located inside the dishwasher at the bottom of the door.

NOTICE

Preparing your Dishwasher for Vacation

Before leaving for vacation during warmer weather, besides turning off the main valve, also turn off water supply at the nearest point to the dishwasher. During colder weather, please follow the instructions for winterizing your unit below.

NOTICE

Winterizing your Dishwasher

If your dishwasher will be unused for an extended period of time in a location that experiences freezing temperatures (holiday home or through a vacation period), have your dishwasher winterized by a professional servicer.

Troubleshooting

Dishwashers may occasionally exhibit problems that are unrelated to a malfunction of the dishwasher itself. The following information may help you with a dishwasher problem without involving a repair professional.

Problem	Cause	Action
Cycle does not resume after door is opened and closed during cycle.	1. Door is opened longer than 4 seconds after a cycle has started.	1. Press [START/RESUME] button again to resume cycle.
Self-latching door not closing properly	1. Self-latching feature will not work properly if dishwasher is not installed correctly.	1. Ensure the alignment of the dishwasher frame is accurate and level.
Dishwasher does not start	1. Door may not be properly latched. 2. Unit may not be turned on. 3. Unit not reset or previous cycle not completed. 4. Delay start engaged. 5. Interruption of electrical power supply to dishwasher or blown fuse. 6. The door may have been closed without first selecting a cycle. 7. Water supply may not be turned on.	1. Shut the door completely until you hear a click. 2. Press the main power switch to turn unit on. 3. To reset, refer to "Cancel a Cycle" section of this manual. 4. To reset, refer to "Delay Start" section of this manual. 5. Check circuit breaker. 6. Select a cycle and close the door. 7. Check and turn on water supply.
Display does not illuminate or console lights are not on	1. A fuse may have been blown or circuit breaker tripped. 2. Door not closed or latched. <i>NOTE: For models with controls on top of the door, the display only illuminate when the door is opened and controls are visible.</i>	1. Check the fuse or circuit breaker box and replace the fuse or reset the breaker if necessary. 2. Ensure door is properly latched and completely closed until you hear it click.

Problem	Cause	Action
Dishwasher seems to run a long time	<ol style="list-style-type: none"> 1. Incoming water is not warm enough. 2. Cycle time can vary due to soil and water conditions. 3. Rinse agent dispenser is empty. 4. Dishwasher connected to cold water supply. <p><i>NOTE: Refer to "Wash Cycle Information" section of this manual for typical cycle lengths.</i></p>	<ol style="list-style-type: none"> 1. Before starting a cycle, run hot water faucet at the sink closest to the dishwasher. 2. Sensors in the dishwasher automatically increase the cycle time to ensure a good wash when heavy soil is detected. 3. Add rinse agent. 4. Verify dishwasher is connected to hot water supply plumbing.
Dishes are not getting clean enough	<ol style="list-style-type: none"> 1. Spray arm movement obstructed. 2. Spray arm nozzles clogged. 3. Improper use of detergents. 4. Filters could be clogged. 5. Dishes are nested or loaded too close together. 6. Selected wash cycle is not suitable for food soil conditions. 	<ol style="list-style-type: none"> 1. Ensure that spray arm movement is not blocked by hand rotating spray arms before starting cycle. 2. Remove the spray arms and clean according to the "Care and Maintenance" section of the manual. 3. Increase or decrease detergent depending on the water hardness (refer to Table 1). 4. Clean the filters according to the "Care and Maintenance" section of the manual. 5. Rearrange load such that water spray can reach all items in the dishwasher - see "Loading the Dishwasher" section of the manual. 6. Refer to "Wash Cycle Information" section of the manual.
Dishes are not getting dry enough	<ol style="list-style-type: none"> 1. Rinse agent dispenser is empty. 2. Improper loading of dishes. 3. Selected cycle does not include drying. 4. Extra Dry Heat is not activated. <p><i>NOTE: Plastic or Teflon do not typically dry as well as other items due to their inherent properties.</i></p>	<ol style="list-style-type: none"> 1. Add rinse agent - the use of rinse agent improves drying. 2. Rearrange load to ensure items are not nesting (see "Loading the Dishwasher" section of the manual). 3. Rinse and Hold setting does not include drying. 4. See the "Operating the Dishwasher" section of this manual to learn how to activate Extra Dry Heat.
Odor <i>Note: Water testing is done in the factory. Occasionally water may still appear in the dishwasher at purchase which may create an odor.</i>	<ol style="list-style-type: none"> 1. Food debris is present at the bottom of the dishwasher. 2. Food particles are present near the door seal. 3. Dishes left in unit too long before running a cycle. 4. Residual water is present at the bottom of the dishwasher. 5. Drain hose is obstructed. 	<ol style="list-style-type: none"> 1. Remove the filters and clean according to the "Care and Maintenance" section of the manual. 2. Refer to "Care and Maintenance" section of the manual. 3. Run a Rinse and Hold cycle if you do not intend to immediately wash the dishes. 4. Ensure the unit has completely drained from the last cycle. 5. Remove any obstructions from the drain hose by calling qualified personnel. <p><i>NOTE: If odor still persists, run the Normal/Regular cycle until it flushes and interrupt the cycle and place an 8 oz. cup of distilled white vinegar solution on the upper rack and then finish the cycle.</i></p>
Dishwasher not filling with water	<ol style="list-style-type: none"> 1. Restriction in the water supply system. 2. Previous wash cycle was not completed. 3. Delay start is active. 4. Household water supply turned off. 	<ol style="list-style-type: none"> 1. Ensure that the water supply valve (typically located under kitchen sink) is open and check that the water supply line has no kinks or clogs. 2. Refer to the "Operating the Dishwasher" section of the manual. 3. Cancel the delay start or wait until delay start time completes. 4. Turn household water supply on.
Water leaks	<ol style="list-style-type: none"> 1. Suds. 2. Door seal could be pulled away from track. 3. Condensation vent is blocked. 4. Improper installation. 	<ol style="list-style-type: none"> 1. Wrong type of detergent results in suds and leaks - use only dishwasher detergents. If suds still persist, add one tablespoon of vegetable oil at the bottom of the dishwasher and run the desired cycle. 2. Ensure the door seal is in the track. 3. Ensure that condensation vent is not blocked. 4. Have proper installation verified by qualified personnel (water supply, drain system, leveling, plumbing).

Problem	Cause	Action
Tub stains	1. Stains on the dishwasher interior are due to water hardness. 2. Silverware in contact with tub.	1. Concentrated lemon juice can reduce the build up of hard water stains. Run a Regular cycle until it flushes and interrupt the cycle and then place an 8 oz. cup of the concentrated lemon solution on the upper rack and finish the cycle. this can be done periodically to avoid build up. 2. Ensure that silverware does not make contact with the tub while running a cycle.
Streaks on glassware or residue on the dishes	1. Incorrect rinse agent setting.	1. Depending on the hardness of water, adjust the rinse agent dispenser. Refer to "Operating the Dishwasher" section of the manual.
Fascia panel discolored or marked	1. Abrasive cleaner used.	1. Use mild detergents with soft damp cloth.
Noise during wash cycle	1. Dishes may not be arranged properly.	1. Water circulation sound is normal, but if you suspect items are banging into each other or into the spray arms, refer to the "Loading the Dishwasher" section on page 6-7 of the manual for optimal arrangement.
Detergent dispenser cover will not shut	1. Improper operation of detergent cover. 2. Previous cycle has not been finished or rest or cycle or interrupted.	1. Refer to "Adding Detergent and Rinse Agent" section on page 9-10 of the manual for instructions on opening and closing the dispenser. 2. Refer to the "Operating the Dishwasher" section of the manual.
Unable to select desired cycle	1. Previous cycle has not finished.	1. Refer to the "Operating the Dishwasher" section of the manual.

Customer Service

Your Bosch® dishwasher requires no special care other than that described in the Care and Maintenance section of this manual. If you are having a problem with your dishwasher, before calling for service please refer to the Self Help section of the manual. If service is necessary, contact your dealer or installer or an authorized service center. Do not attempt to repair the appliance yourself. Any work performed by unauthorized personnel may void the warranty.

If you are having a problem with your Bosch® dishwasher and are not pleased with the service you have received, please take the following steps until the problem is corrected to your satisfaction:

- 1 Call us at 1-800-944-2904
- 2 Contact Customer Service from our web site: www.bosch-home.com/us or www.bosch-appliances.ca
- 3 Contact your installer or the Bosch® Authorized Service Contractor in your area.
- 4 Write us: <http://www.bosch-home.com/us/customer-support/contact-us.html>

Please be sure to include your model information as well as an explanation of the problem and the date it started. You will find the model and serial number information on the label located on the edge of the dishwasher door. Please make a copy of your invoice and keep it with this manual. The customer must show proof of purchase to obtain warranty service.

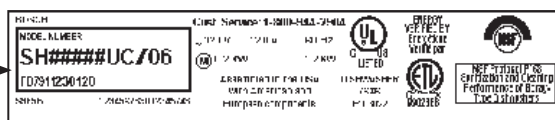

Warranty Information

What this Warranty Covers & Who it Applies to: The limited warranty provided by BSH Home Appliances Corporation (Bosch®) in this Statement of Limited Product Warranty applies only to Bosch® dishwashers (“Product”) sold to you, the first using purchaser, provided that the Product was purchased: (1) for your normal, household (non-commercial) use, and has in fact at all times only been used for normal household purposes; (2) new at retail (not a display, “as is”, or previously returned model), and not for resale, or commercial use; and (3) within the United States or Canada, and has at all times remained within the country of original purchase. The warranties stated herein apply only to the first purchaser of the Product and are not transferable.

• Please make sure to return your registration card; while not necessary to effectuate warranty coverage, it is the best way for Bosch® to notify you in the unlikely event of a safety notice or product recall.

How Long the Warranty Lasts: Bosch® warrants that the Product is free from defects in materials and workmanship for a period of three hundred sixty five (365) days from the date of purchase. The foregoing timeline begins to run upon the date of purchase, and shall not be stalled, tolled, extended, or suspended, for any reason whatsoever. Labor and shipping costs are included in this basic coverage.

Extended Limited Warranty: Bosch® also provides these additional limited warranties:

• 5 Year Limited Warranty on Electronics: Bosch® will repair or replace any Bosch® microprocessor or printed circuit board if it proves to be defective in materials or workmanship (excludes labor charges).

• 5 Year Limited Warranty on Dish Racks: Bosch® will replace the upper or lower dish rack (excluding rack components), if the rack proves defective in materials or workmanship (excludes labor charges).

• Lifetime Warranty against Stainless Steel Rust Through: Bosch® will replace your dishwasher with the same model or a current model that is substantially equivalent or better in functionality, if the inner liner should rust through (excludes labor charges).

• Bosch® will replace the stainless steel door if the door should rust through (excludes labor charges).

The foregoing timeline begins to run upon the date of purchase, and shall not be stalled, tolled, extended, or suspended, for any reason whatsoever.

Repair/Replace as Your Exclusive Remedy: During this warranty period, Bosch® or one of its authorized service providers will repair your Product without charge to you (subject to certain limitations stated herein) if your Product proves to have been manufactured with a defect in materials or workmanship. If reasonable attempts to repair the Product have been made without success, then Bosch® will replace your Product (upgraded models may be available to you, in the sole discretion of Bosch®, for an additional charge). All removed parts and components shall become the property of Bosch® at its sole option. All replaced and/or repaired parts shall assume the identity of the original part for purposes of this warranty and this warranty shall not be extended with respect to such parts. Bosch®’s sole liability and responsibility hereunder is to repair manufacturer-defective Product only, using a Bosch®-authorized service provider during normal business hours. For safety and property damage concerns, Bosch® highly recommends that you do not attempt to repair the Product yourself, or use an unauthorized servicer; Bosch® will have no responsibility or liability for repairs or work performed by a non-authorized servicer. If you choose to have someone other than an authorized service provider work on your Product, THIS WARRANTY WILL AUTOMATICALLY BECOME NULL AND VOID. Authorized service providers are those persons or companies that have been specially trained on Bosch® products, and who possess, in the opinion of Bosch®, a superior reputation for customer service and technical ability (note that they are independent entities and are not agents, partners, affiliates or representatives of Bosch®). Notwithstanding the foregoing, Bosch® will not incur any liability, or have responsibility, for the Product if it is located in a remote area (more than 100 miles from an authorized service provider) or is reasonably inaccessible, hazardous, or treacherous locale, surroundings, or environment; in any such event, if you request, Bosch® would still pay for labor and parts and ship the parts to the nearest authorized service provider, but you would still be fully liable and responsible for any travel time or other special charges by the service company, assuming they agree to make the service call.

Out of Warranty Product: Bosch® is under no obligation, at law or otherwise, to provide you with any concessions, including repairs, pro-rates, or Product replacement, once this warranty has expired.

Warranty Exclusions: The warranty coverage described herein excludes all defects or damage that are not the direct fault of Bosch®, including without limitation, one or more of the following: (1) use of the Product in anything other than its normal, customary and intended manner (including without limitation, any form of commercial use, use or storage of an indoor product outdoors, use of the Product in conjunction with air or water-going vessels); (2) any party’s willful misconduct, negligence, misuse, abuse, accidents, neglect, improper operation, failure to maintain, improper or negligent installation, tampering, failure to follow operating instructions, mishandling, unauthorized service (including self-performed “fixing” or exploration of the appliance’s internal workings); (3) adjustment, alteration or modification of any kind; (4) a failure to comply with any applicable state, local, city, or county electrical, plumbing and/or building codes, regulations, or laws, including failure to install the product in strict conformity with local fire and building codes and regulations; (5) ordinary wear and tear, spills of food, liquid, grease accumulations, or other substances that accumulate on, in, or around the Product; and (6) any external, elemental and/or environmental forces and factors, including without limitation, rain, wind, sand, floods, fires, mud slides, freezing temperatures, excessive moisture or extended exposure to humidity, lightning, power surges, structural failures surrounding the appliance, and acts of God. In no event shall Bosch® have any liability or responsibility whatsoever for damage to surrounding property, including cabinetry, floors, ceilings, and other structures or objects around the Product. Also excluded from this warranty are scratches, nicks, minor dents, and cosmetic damages on external surfaces and exposed parts; Products on which the serial numbers have been altered, defaced, or removed; service visits to teach you how to use the Product, or visits where there is nothing wrong with the Product; correction of installation problems (you are solely responsible for any structure and setting for the Product, including all electrical, plumbing or other connecting facilities, for proper foundation/flooring, and for any alterations including without limitation cabinetry, walls, floors, shelving, etc.); and resetting of breakers or fuses.

TO THE EXTENT ALLOWED BY LAW, THIS WARRANTY SETS OUT YOUR EXCLUSIVE REMEDIES WITH RESPECT TO PRODUCT, WHETHER THE CLAIM ARISES IN CONTRACT OR TORT (INCLUDING STRICT LIABILITY, OR NEGLIGENCE) OR OTHERWISE. THIS WARRANTY IS IN LIEU OF ALL OTHER WARRANTIES, WHETHER EXPRESS OR IMPLIED. ANY WARRANTY IMPLIED BY LAW, WHETHER FOR MERCHANTABILITY OR FITNESS FOR A PARTICULAR PURPOSE, OR OTHERWISE, SHALL BE EFFECTIVE ONLY FOR THE PERIOD THAT THIS EXPRESS LIMITED WARRANTY IS EFFECTIVE. IN NO EVENT WILL THE MANUFACTURER BE LIABLE FOR CONSEQUENTIAL, SPECIAL, INCIDENTAL, INDIRECT, “BUSINESS LOSS”, AND/OR PUNITIVE DAMAGES, LOSSES, OR EXPENSES, INCLUDING WITHOUT LIMITATION TIME AWAY FROM WORK, HOTELS AND/OR RESTAURANT MEALS, REMODELLING EXPENSES IN EXCESS OF DIRECT DAMAGES WHICH ARE DEFINITELY CAUSED EXCLUSIVELY BY BOSCH®, OR OTHERWISE. SOME STATES DO NOT ALLOW THE EXCLUSION OR LIMITATION OF INCIDENTAL OR CONSEQUENTIAL DAMAGES, AND SOME STATES DO NOT ALLOW LIMITATIONS ON HOW LONG AN IMPLIED WARRANTY

LASTS, SO THE ABOVE LIMITATIONS MAY NOT APPLY TO YOU. THIS WARRANTY GIVES YOU SPECIFIC LEGAL RIGHTS, AND YOU MAY ALSO HAVE OTHER RIGHTS WHICH VARY FROM STATE TO STATE. No attempt to alter, modify or amend this warranty shall be effective unless authorized in writing by an officer of BSH Home Appliances Corporation.

How to Obtain Warranty Service: TO OBTAIN WARRANTY SERVICE FOR YOUR PRODUCT, YOU SHOULD CONTACT THE NEAREST BOSCH® AUTHORIZED SERVICE CENTER, OR CALL 1-800-944-2904.