

dacor[®]

User Manual

Modernist Range Hood

DHD30M967WM, DHD36M976WM, DHD48M987WM
DHD30M967WS, DHD36M976WS, DHD48M987WS

Contents

Important information	4
Safety information	5
What you need to know about safety instructions	5
State of California Proposition 65 warning (US only)	6
For your safety	6
General safety	7
Introducing your new hood	9
Overview	9
Dimensions	9
What's included with your hood	10
Operations	11
Control panel	11
Things to do before you start	11
Using the fan	12
Important operating tips	12
Energy saving tips	12
Using the lights	13
Setting/Turning off the timer	13
Muting/Unmuting the control sound	14
Resetting the clean filter light	14
About the Auto-ON safety feature	15
About the ConnectOn™	15
Before using the ConnectOn™ feature	16
Using the ConnectOn™ feature	16
Care and maintenance	17
Care and cleaning of the hood.	17
Removing the filters	18
Cleaning the filters and grease channel	19
Reinstalling the filters and grease channel	19
Replacing the light bulbs	20
Replacement parts	21
Troubleshooting	22
Warranty and Service	24
Getting Help	24
Warranty	24



To Our Valued Customer:

Congratulations on your purchase of the very latest in Dacor® products! Our unique combination of features, style and performance make us The Life of the Kitchen™, and a great addition to your home.

In order to familiarize yourself with the controls, functions and full potential of your new Dacor Appliance, read this use and care manual thoroughly, beginning with the **Important Safety Instructions** section.

All Dacor appliances are designed and manufactured with quality and pride, while working within the framework of our company value. Should you ever experience a problem with your product, please first check the Troubleshooting section of this manual for guidance. It provides useful suggestions and remedies prior to calling for service.

Valuable customer input helps us to continuously improve our products and services, so please feel free to contact our Customer Service Team for assistance with any of your product support needs.

Dacor Customer Service Team
14425 Clark Avenue
City of Industry, CA 91745

Telephone: (800) 793-0093
Fax: (626) 403-3130
Hours of Operation: Monday through Friday 6:00 A.M. to 5:00 P.M. Pacific Time
Website: www.Dacor.com

Thank you for choosing Dacor for your home. We are a company built by families for families, and we are dedicated to serving yours. We are confident that your new Dacor product will deliver a high level of performance and enjoyment for many years to come.

Sincerely,

The Dacor Customer Service Team

Important information

Installer: Leave these instructions with the appliance.

Customer: Read this use and care manual completely before using your Hood. Save it for future reference. It contains important use and care information.

For service and warranty information see page 24.

If you have any questions (other than warranty questions), call:

Dacor Customer Service

(800) 793-0093 (U.S.A. and Canada)

Monday – Friday 6:00 a.m. to 5:00 p.m. Pacific Time

Web site: www.dacor.com

When you call, have the complete model and serial number for your appliance available. The numbers are found on the product data label located on back of the drawer front. See page 3 for label location. Write these numbers below for future reference.

Model number _____

Serial number _____

Date of purchase _____

Since Dacor continuously improves the quality and performance of our products, we may need to make changes to the appliance without updating this manual. Visit www.dacor.com to download the latest version of this manual.

Energy-saving

- For most efficient function, keep the filter system and hood surfaces free of grease and debris.
- Select cookware (size, material, construction) appropriate to the task.

Safety information

The **Important Safety Instructions** and warnings in this manual do not all possible problems/situations. Use common sense and cautiocovern when installing, maintaining, and operating this or any other appliance. Always contact the Dacor Customer Service Team about problems or situations that you do not understand.

What you need to know about safety instructions

Warnings and important safety instructions in this manual do not cover all possible conditions and situations that may occur. It is your responsibility to use common sense, caution, and care when installing, maintaining, and operating your oven.

Important safety symbols and precautions

What the icons and signs in this user manual mean:

WARNING









Hazards or unsafe practices that may result in **severe personal injury or death**.

CAUTION

Hazards or unsafe practices that may result in **minor personal injury or property damage**.

CAUTION

To reduce the risk of fire, explosion, electric shock, or personal injury when using your drawer, follow these basic safety precautions.

-  Do NOT attempt.
-  Do NOT disassemble.
-  Do NOT touch.
-  Follow directions explicitly.
-  Unplug the power plug from the wall socket.
-  Make sure the machine is grounded to prevent electric shock.
-  Call a Dacor Customer Service for help.
-  Note

These warning signs are here to prevent injury to you and others. Please follow them explicitly.

After reading this section, keep it in a safe place for future reference.

Safety information

State of California Proposition 65 warning (US only)

WARNING: This product contains one or more chemicals known to the State of California to cause cancer.

WARNING: This product contains one or more chemicals known to the State of California to cause birth defects or other reproductive harm.

For your safety

When using electrical appliances, you should follow basic safety precautions, including the following:

CAUTION

- Use this appliance only for its intended purpose as described in this Owner's Manual.
- Potentially hot surfaces include the oven vent opening, surfaces near the opening, and crevices around the oven door.

 **Proper Installation** - Be sure your appliance is properly installed and grounded by a qualified technician.

 **User servicing** - Do not repair or replace any part of the appliance unless specifically recommended in this manual. All other servicing should be referred to a qualified technician.

 Always disconnect the power to the appliance before servicing by removing the fuse or switching off the circuit breaker.

WARNING

- To avoid a possible explosion or fire, do not store/use combustible, flammable, or explosive vapors and liquids (e.g., gasoline) inside or around this or any other appliance. Also, keep items that could explode (e.g., aerosol cans) away from cooktop burners, ovens, and range hoods. Do not store flammable/explosive materials in adjacent cabinets/areas.

⚠ WARNING

- TO REDUCE THE RISK OF FIRE, ELECTRIC SHOCK, OR PERSONAL INJURY
 - a. Use this unit only as intended by the manufacturer. If you have questions, contact the manufacturer.
 - b. Before servicing/cleaning the unit, turn power off at the service panel, and lock the service disconnecting means so power cannot be switched on accidentally. If you cannot lock the service disconnecting means, securely fasten a prominent warning device (e.g., tag) to the service panel.

General safety

⚠ WARNING

- To reduce the risk of fire, electric shock, serious injury, or death when using your range hood, follow basic safety precautions, including these
- If you receive a damaged product, immediately contact your dealer/builder. Do not install/use a damaged hood.
- Verify that the hood was properly installed and grounded by a qualified installer according to procedures in this guide.
Have the installer show you the fuse or junction box so you can turn the power ON/OFF as needed.
- Do not install/repair/replace any part of the range hood unless specifically recommended by the procedures in this guide. A qualified service technician should perform all other service.
- To avoid risk of electric shock:
 - Before service is performed, switch power off at the fuse/junction box, and lock the electrical-panel door so power cannot be switched on accidentally. If the electrical panel cannot be locked, securely fasten a prominent warning device (e.g., tag) to the panel.
 - Before cleaning the hood, turn off the main power switch (Pg. 3).
- Use the hood only as outlined in this manual. Do NOT use the hood to vent hazardous/explosive materials or vapors.
If you have questions, contact Dacor (contact info on Pg. 1).
- Do not tamper with the controls.
- Never let the filters become blocked/clogged, or foreign objects (e.g., cigarettes, napkins) be sucked into the hood.
- To avoid a fire hazard: If the range/cooktop is near a window, do not use window coverings that could blow over the cooking surface and hood.
- Always run the hood fans when using your range/cooktop.

Safety information

⚠ WARNING

- Concerning children:
 - Never leave children in the vicinity of an operating range/cooktop.
 - Never let children sit/stand on/play with your range/cooktop and hood; or store items of interest to children above/around these appliances.
- The minimum vertical distance between the cooking surface and the bottom-most part of the hood must be at least 30" (76.2 cm). Consult the hood Installation Instructions for the minimum vertical distance in your specific case.
- To reduce risk of a grease fire:
 - never leave the range/cooktop unattended at high settings; boil-overs cause smoking and greasy spill-overs that may ignite; heat oils slowly on low/medium settings
 - always turn the hood ON when cooking at high heat or when flambéing food (e.g., Crepes Suzette, Cherries Jubilee, Peppercorn Beef Flambé)
 - clean ventilating fans frequently; do not let grease accumulate on the filter or other hood components
 - always use cookware appropriate to the size of the surface element or grate.
- TO REDUCE RISK OF PERSONAL INJURY FROM A COOKTOP GREASE FIRE:
 - CAREFULLY SMOTHER FLAMES with a close-fitting lid, cookie sheet, or metal tray, then turn off the burner. If the flames do not die immediately, EVACUATE, THEN CALL THE FIRE DEPARTMENT.
 - NEVER PICK UP A FLAMING PAN.
 - DO NOT try to extinguish flames with water or wet dish cloths/towels; a violent steam explosion may result.
- (FOR GREASE FIRES) USE A FIRE EXTINGUISHER ONLY IF:
 - you have a Class ABC extinguisher and know how to operate it
 - the fire is small and contained in its area of origin
 - the fire department is being called
 - you can fight the fire with your back to an exit.

Introducing your new hood

Overview

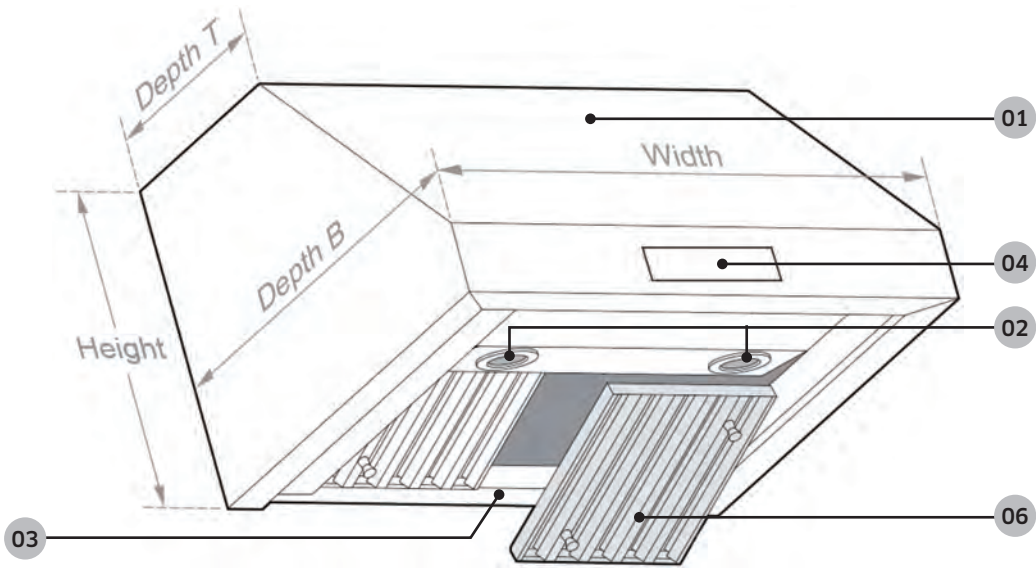

01 Hood Canopy

02 Lights

03 Grease Channel

04 Control Panel

05 Filters

Dimensions

Model	Width	Height	Depth B	Depth T	Filters	Lights
DHD30	30"	18"	24"	11 7/8"	2	2
DHD36	36"	18"	24"	11 7/8"	3	3
DHD48	48"	18"	24"	11 7/8"	4	4

Introducing your new hood

What is included

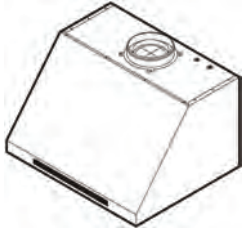

Hood (1)
(models vary in size)

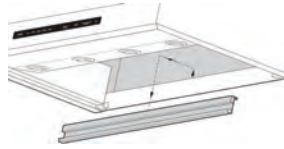

Grease channel (1)

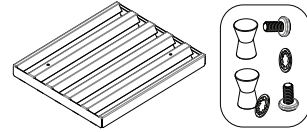

Baffle-style filter*
48" (4), 36" (3), 30" (2)

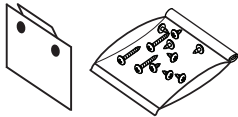

Holding brackets, Hardware
(2)



Dimmable LED light bulbs
48" (4), 36" (3), 30" (2)



Light-replacement tool (1)



Product literature** (2)



Dacor cleaning cream (1)
stainless steel units only

* Ready-to-assemble kit (see pg. 21)

** Installation instructions, User manual.

Operations

Control panel

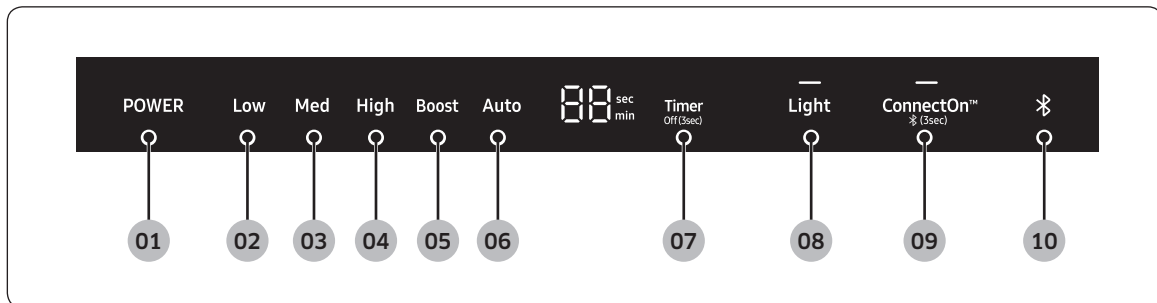

- 01 POWER** : Turn on/off the Hood
- 02 Low** : Activate the hood at Low speed
- 03 Med** : Activate the Hood at Medium speed
- 04 High** : Activate the Hood at High speed
- 05 Boost** : Activate the Hood at maximum speed
- 06 Auto** : Decrease the temperature.
- 07 Timer** : Set the Timer
- 08 Light** : Turn on/off the lights
- 09 ConnectOn™** : Activate the ConnectOn™ function.
- 10 Bluetooth indicator**

Before you start

1. Install LED Lamps provided in the installation kit.
2. Grasp the tab in the upper-right corner of the control panel, and peel away the protective film.
3. Install filters.

Operations

Using the fan

Fan speed is indicated by the word that appears on the fan-speed portion of the display bar.

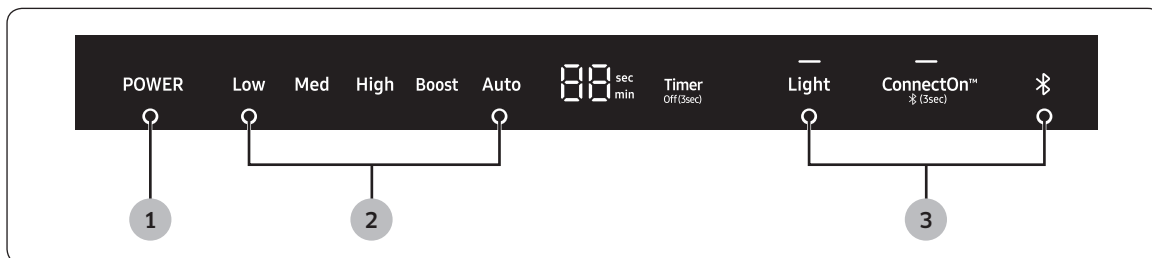

1. Press the **POWER** button.
The fan comes on at the lowest speed.
2. Press the **Med**, **High**, **Boost** button to increase the speed.
The fan changes speed.
3. Press the **POWER** button.
The fan turns off.

Important operating tips

- Always use the fan when cooking.
- Turn the fan on a few minutes before cooking to establish an airflow current in the room.
- Adjust the fan speed to the volume and weight of the food being cooked.
- Shut nearby windows and doors, turn off ceiling fans, and close nearby heating and AC vents to reduce drafts around the hood.
- Place your largest pots and pans on the back burners when possible.
- For safety's sake, heat oils and fats slowly

Energy saving tips

- For most efficient function, keep the filter system and hood surfaces free of grease and debris.
- Select cookware (size, material, construction) appropriate to the task.

Using the lights

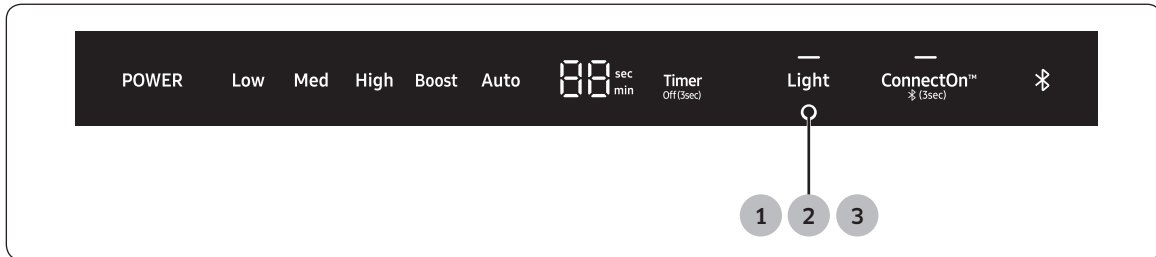

1. Press the **Light** button.
The lights come on at the high setting.
2. Press the **Light** button a second time.
The lights turn dimmer.
3. Press the **Light** button a third time. The lights turn off.

Setting/Turning off the timer

Your hood has a timer that automatically turns the fan off.

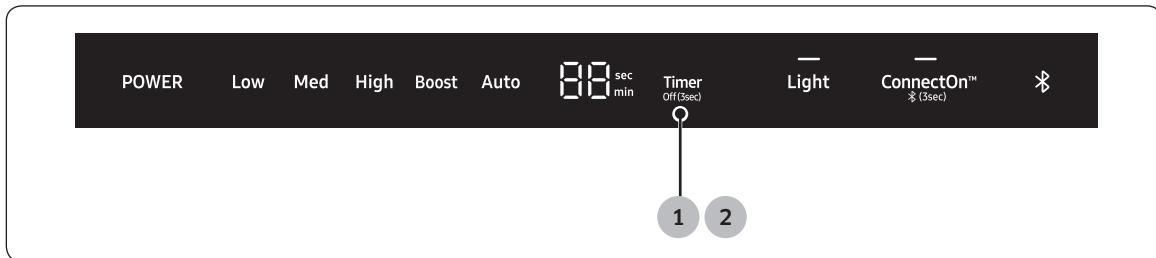

1. Press the **Timer** button to set the desired time setting.
The hood will stay on for the amount of time you have set.

NOTE

Each time you press the **Timer** button, you add 10 min to the display time, up to a maximum of 99 min.

2. Press the **Timer** button for 3 sec.
The Timer function will turn off.

Operations

Muting/Unmuting the control sound

You can enable/disable the hood's control panel sounds.

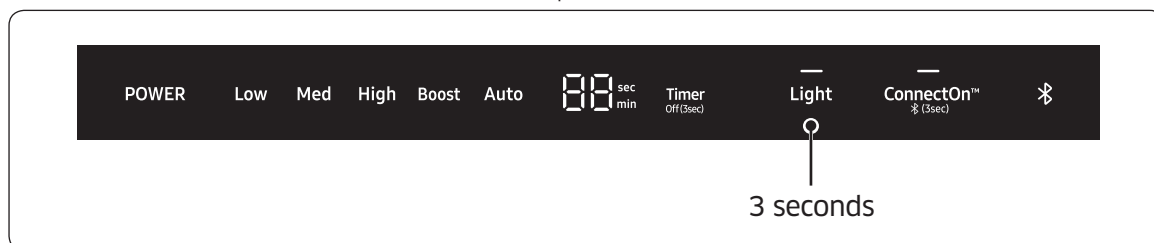

1. Press-hold **Light** for 3 seconds to mute the control panel sound (beep).
2. Press-hold **Light** again for 3 seconds to enable the sound (beep).

Resetting the clean filter light

Every 50 hours of fan use, the Clean Filter light comes on, indicating the filters may need to be cleaned.

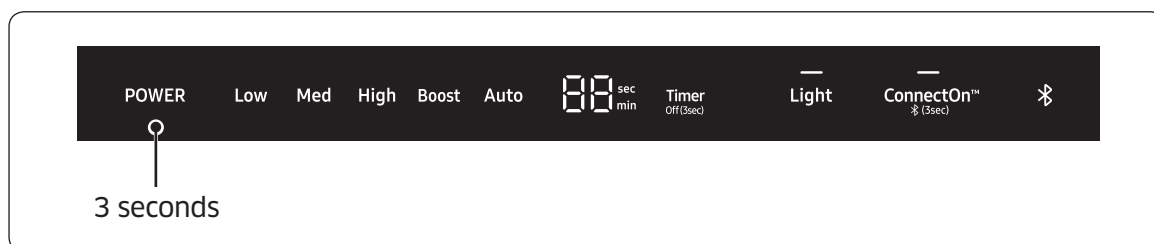

1. To reset the Clean Filter Light, press on **POWER** button for 3 seconds.
2. Clean the filters if needed. (See **Cleaning the filters and grease channel**, page 19).

About the Auto-ON safety feature

To protect the electronics from heat damage, the fan automatically turns ON if Auto-ON is enabled or if the unit is connected via Bluetooth with a Dacor cooktop and the cooktop is on. Press POWER to manually turn off the fan. Fan speed increases with heat.

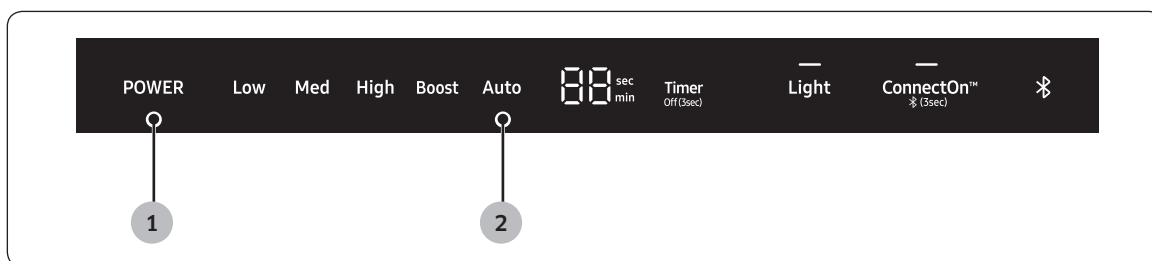

1. Press on the **POWER** pad or select a different fan speed. the Auto Light will turn OFF.

About ConnectOn™

- Before using ConnectOn™, set up this feature on your compatible Dacor cooktop.
- This appliance has a feature which allows you to pair compatible Dacor cooktops and your hood via Bluetooth.
- After hood and compatible cooktop are paired. you can download the Dacor Smart Home app to a mobile device, and then use it to:
 - Monitor and control the On/Off status of hood.
 - Monitor and control the fan speed.
 - Monitor ad control the lights.
 - Set the hood shut-off timer with the time-up alarm.
- For more information about the downloading the Dacor Smart app to your mobile device and using it to control your hood, visit: www.dacor.com

Operations

Before using ConnectOn™

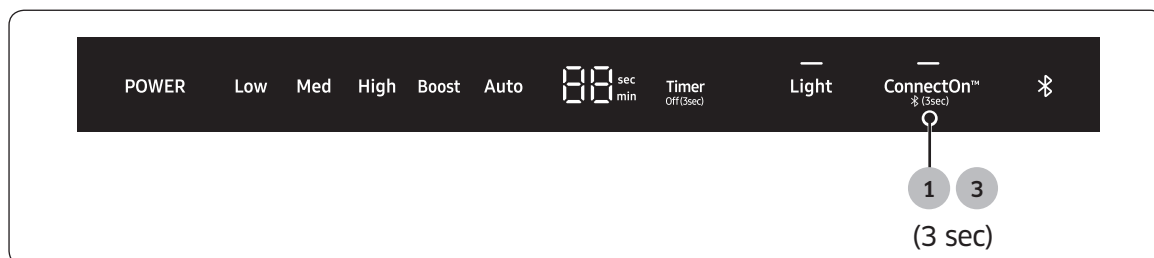

1. Press **ConnectOn™** for 3 seconds.
The pairing mode will be activated and the indicator of Bluetooth symbol will flash.
2. Press the **Bluetooth** button on your compatible Dacor cooktop.
The hood and the cooktop will be paired.

NOTE

For a detailed description of the pairing method, see the user manual of a compatible Dacor cooktop.

3. Press-hold the **Bluetooth** button for 3 second again.

Using ConnectOn™

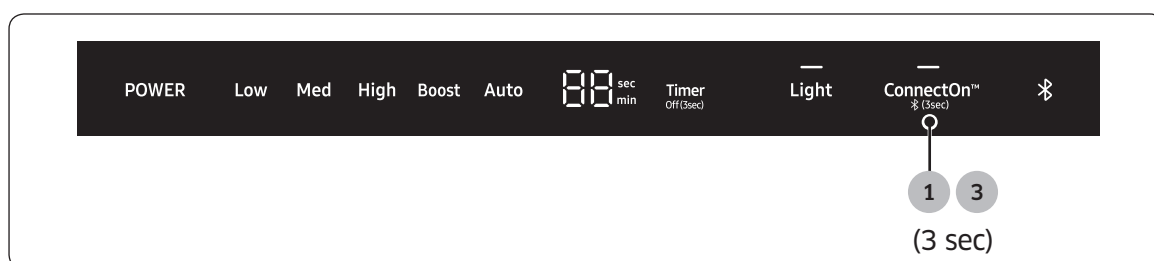

1. Press **ConnectOn™**.
This function will be activated.
2. Turn on the cooktop.
The hood will activate automatically. (default : Auto)

Care and maintenance

Care and cleaning of the hood.

Cleaning the Stainless Steel and Painted Surfaces

- Regularly use a dry cloth to remove all foreign substances such as dust or water from the power plug terminals and contact points.
- Clean stainless steel surfaces and Painted Surfaces with a mild solution of dishwashing liquid and warm water, always wiping with the grain.
(For best results, Dacor recommends you use Dacor Stainless-Steel Cleaner, according to package directions).
- Do not clean with abrasive cleaners or abrasive cloths.
- Rinse and dry with a micro-fiber or other soft, lint-free cloth.
- Do not use benzene, thinner, or home/car detergent to clean the hood.
- Do not spray water onto the hood. This may cause electric shock.
- Do not put fingers or any objects into the hood.

Control Panel

- Clean the control panel with a soft cloth dampened with a mild detergent-hot water solution.
- Rinse and dry with a soft cloth.
- Exercise caution to avoid introduction of liquids into the area behind the control panel.
- Do not use abrasive cleaners or scrubbers. They may permanently damage the finish or scrape off the letters and graphics.

WARNING

To avoid the risk of fire/electric shock/personal injury:

- Turn off power to the hood at the circuit-breaker panel or fuse box before cleaning.
- Clean the hood only as directed with the cleaning solutions specified in this manual.
- Thoroughly dry the filter(s) immediately after cleaning.
- Turn off the cooktop/range, and ensure the appliance has cooled sufficiently before cleaning it and the hood.
- To avoid damaging the fan, do not reinstall damaged filters.

Care and maintenance

Removing the filters

The filters are under the hood toward the rear. These external components lie directly above all heat, steam, and particulates that are drawn upward into the blower(s).

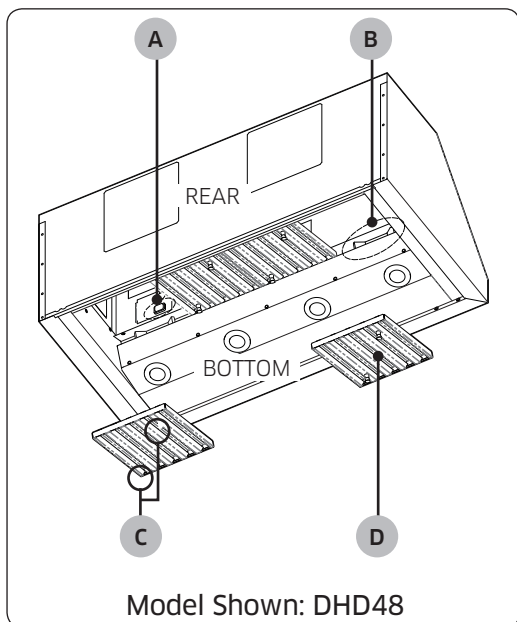

1. Tension clips at the front of the hood hold the filters in place.
2. You can easily access the main power switch when the filter beneath it is removed.
3. In performing this procedure, take care not to bump the switch or scratch the grease channel along the hood's bottom-rear edge.
4. If you cannot reach the filters from the floor, Dacor recommends you use a stepstool or similar sturdy device to help you reach up into the hood.

- A. Main power switch
- B. Tension clip
- C. Filter knob
- D. Filter

Cleaning the filters and grease channel

If you cannot reach the grease channel from the floor, Dacor recommends you use a stepstool or similar sturdy device to help you reach up into the hood.

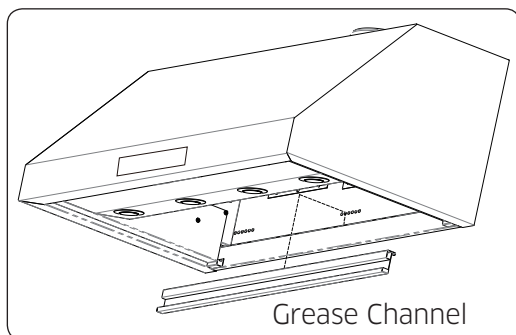

1. Unhinge (lift with both hands and detach), and clean the grease channel with a hot, soapy sponge.
2. Wash the filters in hot, soapy water, or in a dishwasher.
3. Thoroughly dry the grease channel and filters.

Reinstalling the filters and grease channel

1. Reattach the grease channel.
2. Grasping the knobs, press the filter's front edge firmly against the tension clip until the filter's rear edge clears the grease channel.
3. Carefully raise the filter's rear edge up into the hood.
4. Gently release tension on the clip, and rest the filter's rear edge on the grease channel.
5. Wipe away fingerprints, and adjust the components as needed.

Care and maintenance

Replacing the light bulbs

⚠ WARNING

- The owner changes the bulb. Before replacing a bulb (or if a light does not work), verify that power is ON at the circuit breaker, fuse box, light switch, or main power switch.
- To prevent electric shock, turn power OFF at the fuse box or circuit breaker panel, then replace the light bulb.
- To avoid risk of fire, use bulbs no stronger than 7.5W LED or 75W, 120V Halogen.
- To avoid a burn injury, ensure the hood and the bulb lens are cool before changing the bulb.
- To avoid system damage and faulty performance, use only dimmable bulbs.

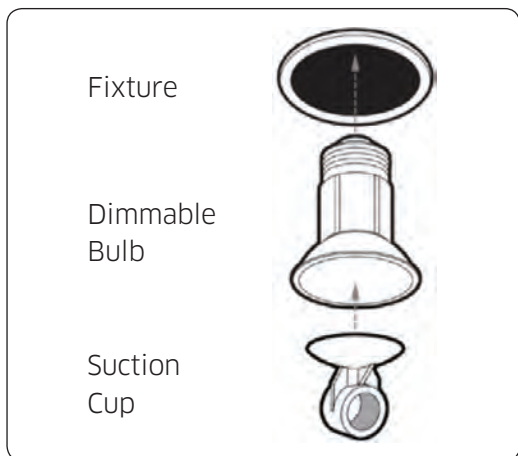
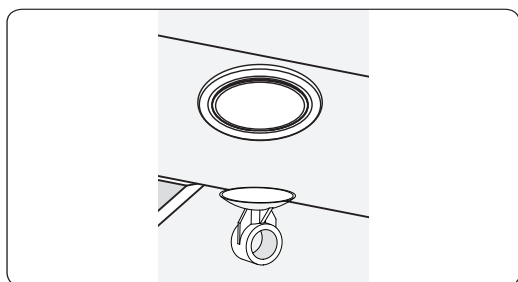

1. (To avoid harming the appliance electrical system should a short occur) Turn power OFF at the circuit breaker or fuse box.
2. Wipe the bulb lens clean, then gently press the suction-cup tool onto the lens.
3. Turn the tool left to loosen the bulb, then remove the bulb from the housing.
4. Attach the suction-cup tool to the lens of the replacement bulb.
5. Insert the bulb into the housing, and turn the tool handle right to tighten the bulb.
6. Remove the suction cup, and turn the power ON at the fuse box or circuit panel.

📄 NOTE

- If buying your own bulb, take the old bulb to the store as reference, or use these specifications: Dimmable LED 7.5W (max) or Halogen 75W (max), 120V; PAR16, E26/27, 500 lumens.
- If the bulb does not engage, ensure the new bulb's lens is clean, then repeat Steps 4 and 5, being sure to insert the bulb fully into the housing.

Replacement parts

Order at www.everything.dacor.com

Dacor Part #	Description
702666	Dimmable LED Bulb Replacement Kit (1 bulb + 1 suction cup tool)
702579	Baffle Filter Kit (1 pc + hardware)
702580	Baffle Filter Kit (2 pc + hardware)

Dacor hoods use either baffle or mesh filter types. Contact Dacor customer service for assistance/information concerning the filter types.

This table shows the model numbers and descriptions of the available filter types:

Model #	Description
AWHBF2/3/4	Baffle filter: 30" (2 filters); 36" (3 filters); 48" (4 filters)

Troubleshooting

This table lists various minor problems concerning the function of the hood, possible causes, and their solutions. If you experience an issue listed in this table, try resolving the problem yourself by applying the corresponding solution. If you are unable to resolve the problem, contact Dacor. (See **Warranty and Service** for business hours and phone number.)

Problem	Cause(s)	Solution
Nothing Works (control panel not lit; fan/lights not working)	Main power switch is OFF Power to hood OFF	Check the main power switch inside the hood; turn on power at junction/fuse box; check for tripped breaker or blown fuse.
	Power outage	Call your electric company
	Hood not connected to power source	Have qualified electrician connect hood to power source.
Light(s) not working (control panel lit; fan working)	Light bulb loose	Screw in bulb completely (Page 20).
	Light bulb burned out	Replace bulb (Page 20).
Fan not drawing heat and smoke properly	Fan speed too low	See Operating Instructions section.
	Filters clogged/dirty Open window, draft, HVAC interference	Make sure filters are clean and free of grease/debris. Check for drafts and airflow interference.
	Damper jammed shut Ducting clogged	Consult qualified installation professional*.
Fan shuts off by itself	Hood's "Timed" feature was set	If timer is set, fan turns off after set time. The max time is 99 min. (Setting/Turning off the timer, page 13).
Fan not working (control panel lit; lights working)	Fan electrical malfunction	Call for service.
Fan comes on by itself	Hood's AUTO-ON feature was started	The exhaust fan comes on automatically if the Auto-ON is enabled or if the unit is connected via Bluetooth with a Dacor cooktop and the cooktop is on. Press POWER to manually turn off the fan.

* Dacor does not manufacture/warrant/service the ducting that vents heat/smoke from the hood's chimney to the outside. The owner shall have a qualified person install/maintain the ducting.

Problem	Cause(s)	Solution
ConnectOn™ function not working	The hood is not connected to the cooktop.	Only a Dacor-compatible cooktop can be paired with the hood. (For details, see Before using ConnectOn™ , pg. 16.)
Bluetooth light blinks or shuts off automatically	The hood has trouble connecting to a compatible range or cooktop	Reset bluetooth on the hood: Press-hold Light and ConnectOn simultaneously for 5 seconds; the display shows bT and changes to rT

Warranty and Service

Getting Help

Before seeking assistance:

1. Review Dacor's Problem-Solution Guide in the **Before You Call For Service** section above.
2. Learn the hood's warranty terms/conditions (next page).

Contact Type	Contact Info
Warranty	Dacor Distinctive Service; US/Canada: (800) 793-0093 x2822; 6:00 a.m. to 5:00 p.m. Pacific Time
Non-warranty	US/Canada: (800) 793-0093 x2813; 6:00 a.m. to 5:00 p.m. Pacific Time
Website	www.dacor.com/contact-us

Warranty

Review this section to learn the warranty and non-warranty terms and conditions concerning this product. For details/clarifications, contact Dacor.

What Is Covered

CERTIFICATE OF WARRANTIES: DACOR OVENS

WITHIN THE FIFTY STATES OF THE U.S.A., THE DISTRICT OF COLUMBIA, AND CANADA:

FULL ONE-YEAR WARRANTY

The warranty applies only to the Dacor appliance sold to the first use purchaser, starting from the date of original retail purchase or closing date for new construction, whichever period is longer. Warranty is valid on products purchased brand new from a Dacor Authorized Dealer, or other seller authorized by Dacor.

If your Dacor product fails to function within one year of the original date of purchase, due to a defect in material or workmanship, Dacor will remedy it without charge to you. All cosmetic damage (such as scratches on stainless steel, paint/porcelain blemishes, etc.) to the product or included accessories must be reported to Dacor within 60 days of the original purchase date to qualify for warranty coverage. Consumable parts such as filters and light bulbs are not covered and are the responsibility of the purchaser.

LIMITATIONS OF COVERAGE

Service will be provided by a Dacor designated service company during regular business hours. Please note service providers are independent entities and are not agents of Dacor. Dealer display and model home display products with a production date greater than 5 years, products sold "As Is," and products installed for non-residential use, which include but are not limited to religious organizations, fire stations, bed and breakfast, and spas carry a one year parts warranty only. All delivery, installation, labor costs, and other service fees are the responsibility of the purchaser.

Warranty will be null and void on product that has altered, defaced, or missing serial numbers and tags.

The owner must provide proof of purchase or closing statement for new construction upon request. All Dacor products must be accessible for service.

Warranty is null and void if non-ETL or non-CUL approved product is transported from the U.S.A.

OUTSIDE THE FIFTY STATES OF THE U.S.A, THE DISTRICT OF COLUMBIA, AND CANADA:

LIMITED FIRST YEAR WARRANTY

If your Dacor product fails to function within one year of the original date of purchase due to a defect in material or workmanship, Dacor will furnish a new part, F.O.B. factory to replace the defective part.

All delivery, installation, labor costs and other service fees are the responsibility of the purchaser.

What Is Not Covered

- Slight color variations may be noticed because of differences in painted parts, kitchen lighting, product placement, and other factors; this warranty does not apply to color variation.
- Service calls to educate the customer on proper use and care of the product.
- Service fees for travel to islands and remote areas, which include but are not limited to, ferries, toll roads or other travel expenses.
- Consequential or incidental damage, including but not limited to food or medicine loss, time away from work or restaurant meals.
- Failure of the product when used for commercial, business, rental or any application other than for residential consumer use.
- Failure of the product caused by improper product installation.
- Replacement of house fuses, fuse boxes or resetting of circuit breakers.
- Damage to the product caused by accident, fire, flood, power interruption, power surges or other acts of God.

Warranty and Service

- Liability or responsibility for damage to surrounding property including cabinetry, floors, ceilings and other structures or objects around the product.
- Breakage, discoloration, or damage to glass, metal surfaces, plastic components, trim, paint or other cosmetic finish caused by improper usage, care, abuse or neglect.

Out of Warranty

Should you experience a service issue beyond the standard warranty period, please contact us. Dacor reviews each issue and customer concern to provide the best possible solution based on the circumstances.

THE REMEDIES PROVIDED IN THE ABOVE EXPRESS WARRANTIES ARE THE SOLE AND EXCLUSIVE REMEDIES. THEREFORE, NO OTHER EXPRESS WARRANTIES ARE MADE, AND OUTSIDE THE FIFTY STATES OF THE UNITED STATES, THE DISTRICT OF COLUMBIA AND CANADA, ALL IMPLIED WARRANTIES, INCLUDING BUT NOT LIMITED TO, ANY IMPLIED WARRANTY OF MERCHANTABILITY OR FITNESS FOR A PARTICULAR USE OR PURPOSE, ARE LIMITED IN DURATION TO ONE YEAR FROM THE DATE OF ORIGINAL PURCHASE. IN NO EVENT SHALL DACOR BE LIABLE FOR INCIDENTAL EXPENSE OR CONSEQUENTIAL DAMAGES. IN THE EVENT DACOR PREVAILS IN ANY LAWSUIT, DACOR SHALL BE ENTITLED TO REIMBURSEMENT OF ALL COSTS AND EXPENSES, INCLUDING ATTORNEY'S FEES, FROM THE DACOR CUSTOMER. NO WARRANTIES, EXPRESS OR IMPLIED, ARE MADE TO ANY BUYER FOR RESALE.

Some states do not allow limitations on how long an implied warranty lasts, or do not allow the exclusion or limitation of inconsequential damages, therefore the above limitations or exclusions may not apply to you. This warranty gives you specific legal rights, and you may also have other rights that vary from state to state.



Please visit www.Dacor.com to activate your warranty online.

WARRANTY INFORMATION



IMPORTANT:

Your warranty will not begin until you activate it online or return this form to Dacor. If you have purchased more than one Dacor product, please return all forms in one envelope, or activate the warranty for each product online.

Please rest assured that under no conditions will Dacor sell your name or any of the information on this form for mailing list purposes. We are very grateful that you have chosen Dacor products for your home and we do not consider the sale of such information to be a proper way of expressing our gratitude!

Owner's Name: _____
Last (Please Print or Type) First Middle

Street: _____

City: _____ State: _____ Zip: _____

Purchase Date: _____ **Email:** _____ **Telephone:** _____

Dealer: _____

City: _____ State: _____ Zip: _____

Your willingness to take a few seconds to fill in the section below will be sincerely appreciated. Thank you.

1. How were you first exposed to Dacor products? (Please check one only.)

- | | |
|---|---|
| <input type="checkbox"/> A. T.V. Cooking Show | <input type="checkbox"/> F. Builder |
| <input type="checkbox"/> B. Magazine | <input type="checkbox"/> G. Architect/Designer |
| <input type="checkbox"/> C. Appliance Dealer Showroom | <input type="checkbox"/> H. Another Dacor Owner |
| <input type="checkbox"/> D. Kitchen Dealer Showroom | <input type="checkbox"/> I. Model Home |
| <input type="checkbox"/> E. Home Show | <input type="checkbox"/> J. Other _____ |

2. Where did you buy your Dacor appliances?

- | | |
|--|---|
| <input type="checkbox"/> A. Appliance Dealer | <input type="checkbox"/> D. Builder |
| <input type="checkbox"/> B. Kitchen Dealer | <input type="checkbox"/> E. Other _____ |
| <input type="checkbox"/> C. Builder Supplier | |

3. For what purpose was the product purchased?

- | | |
|---|---|
| <input type="checkbox"/> A. Replacement only | <input type="checkbox"/> C. New Home |
| <input type="checkbox"/> B. Part of a Remodel | <input type="checkbox"/> E. Other _____ |

4. What is your household income?

- | | |
|---|---|
| <input type="checkbox"/> A. Under \$75,000 | <input type="checkbox"/> D. \$150,000 - \$200,000 |
| <input type="checkbox"/> B. \$75,000 - \$100,000 | <input type="checkbox"/> E. \$200,000 - \$250,000 |
| <input type="checkbox"/> C. \$100,000 - \$150,000 | <input type="checkbox"/> F. Over \$250,000 |

5. What are the brands of appliances that you have in your kitchen?

- | | |
|------------------|-----------------------|
| A. Cooktop _____ | C. Dishwasher _____ |
| B. Oven _____ | D. Refrigerator _____ |

6. Would you buy or recommend another Dacor product?

- | | |
|------------------------------|-----------------------------|
| <input type="checkbox"/> Yes | <input type="checkbox"/> No |
|------------------------------|-----------------------------|

Comments: _____

Thank you very much for your assistance. The information you have provided will be extremely valuable in helping us plan for the future and giving you the support you deserve.

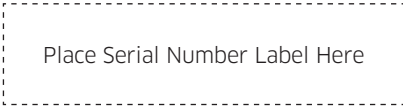

Website: www.Dacor.com
Phone: 1+800+793-0093

cut here

cut here

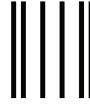

NO POSTAGE
NECESSARY
IF MAILED
IN THE
UNITED STATES

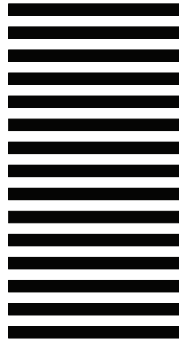

BUSINESS REPLY MAIL
FIRST-CLASS MAIL PERMIT NO 1600 CITY OF INDUSTRY CA

POSTAGE WILL BE PAID BY ADDRESSEE

DACOR
ATTN: WARRANTY PROCESSING DEPT
PO BOX 90070
CITY OF INDUSTRY, CA 91715-9907



fold here

