

***dacor***<sup>®</sup>

User Manual

---

**Modernist Built-In Electric Wall Oven**

DOB30M977S\*

# Contents

---

<b>Important information</b>	<b>5</b>
Energy-saving tips	5
<b>Safety information</b>	<b>6</b>
What you need to know about safety instructions	6
State of California Proposition 65 warning (US only)	8
For your safety	8
Electrical safety	10
Child safety	10
Oven	11
Self-cleaning ovens	12
Ventilating hood	12
Critical installation warnings	13
Critical usage warning	14
Usage cautions	16
Critical cleaning warnings	17
<b>Introducing your new oven</b>	<b>18</b>
Overview	18
What's included with your oven	18
<b>Operations</b>	<b>19</b>
Control panel	19
Display	20
Water reservoir	21
Control lockout	23
Kitchen timer	24
Timed cooking	26
Delay start	28
Using the oven racks	29
Using the gliding rack	32
Using the temp probe	34
Oven functions	37
Setting the mode	41
Setting the temperature	42
Basic baking and broiling instructions	42

---

Using the special function feature	46
Using the Chef Mode feature	49
Using the iQ control feature	50
Using the clean feature	52
Settings	61
Using the sabbath feature	65
<b>Care and maintenance</b>	<b>67</b>
Care and cleaning of the oven	67
Removing the oven doors	75
Reinstalling the oven doors	76
Changing the oven light	78
<b>Troubleshooting</b>	<b>79</b>
Information codes	83
<b>Warranty and Service</b>	<b>85</b>
Getting Help	85
Warranty	85
<b>Regulatory Notice</b>	<b>88</b>
<b>Open Source Announcement</b>	<b>90</b>

---



To Our Valued Customer:

Congratulations on your purchase of the very latest in Dacor® products! Our unique combination of features, style and performance make us The Life of the Kitchen™, and a great addition to your home.

In order to familiarize yourself with the controls, functions and full potential of your new Dacor Appliance, read this use and care manual thoroughly, beginning with the **Important Safety Instructions** section.

All Dacor appliances are designed and manufactured with quality and pride, while working within the framework of our company value. Should you ever experience a problem with your product, please first check the Troubleshooting section of this manual for guidance. It provides useful suggestions and remedies prior to calling for service.

Valuable customer input helps us to continuously improve our products and services, so please feel free to contact our Customer Service Team for assistance with any of your product support needs.

Dacor Customer Service Team  
14425 Clark Avenue  
City of Industry, CA 91745

**Telephone:** (800) 793-0093

**Fax:** (626) 403-3130

**Hours of Operation:** Monday through Friday 6:00 A.M. to 5:00 P.M. Pacific Time

**Website:** [www.Dacor.com](http://www.Dacor.com)

Thank you for choosing Dacor for your home. We are a company built by families for families, and we are dedicated to serving yours. We are confident that your new Dacor product will deliver a high level of performance and enjoyment for many years to come.

Sincerely,

*The Dacor Customer Service Team*

# Important information

---

Clean the oven thoroughly before using it the first time. Then, remove the racks, set the oven to Bake at 400 °F for 1 hour. There will be a distinctive odor. This is normal. The kitchen should be well ventilated during this conditioning session.

## Energy-saving tips

---

- Leave the oven door closed except to turn food.
- For cook times over 30 minutes, you can turn the oven off 5-10 minutes early. The residual heat will finish cooking the food.
- Plan your cooking schedule so you do not have to turn the oven off between items.
- When possible, cook multiple items together.

# Safety information

---

Read and follow all directions before using your oven to avoid risk of fire, electric shock, personal injury, or other damage. Contact your service agent or the manufacturer about issues you do not understand or cannot resolve through troubleshooting (pg. 79).

## What you need to know about safety instructions

---

Warnings and important safety instructions in this manual do not cover all possible conditions and situations that may occur. It is your responsibility to use common sense, caution, and care when maintaining, and operating your oven.

### Important safety symbols and precautions

What the icons and signs in this user manual mean:

#### **WARNING**

Hazards or unsafe practices that may result in **severe personal injury or death**.

#### **CAUTION**

Hazards or unsafe practices that may result in **minor personal injury or property damage**.

---

## CAUTION

To reduce the risk of fire, explosion, electric shock, or personal injury when using your oven, follow these basic safety precautions.

-  Do NOT attempt.
-  Do NOT disassemble.
-  Do NOT touch.
-  Follow directions explicitly.
-  Unplug the power plug from the wall socket.
-  Make sure the machine is grounded to prevent electric shock.
-  Call a Dacor Customer Service for help.
-  Note

Keep this manual in a convenient place for reference.

# Safety information

---

## State of California Proposition 65 warning (US only)

---

**WARNING :** This product contains chemicals known to the State of California to cause cancer and birth defects or other reproductive harm.

## For your safety

---

When using electrical appliances, follow basic safety precautions, including:

### **CAUTION**

- Use the oven only as instructed in this manual.
- Potentially hot surfaces include the oven vent opening, surfaces near the opening, and crevices around the oven door.
-  Ensure the oven is properly installed and grounded by a qualified technician.
-  Do not repair/replace any components unless as specifically recommended in this manual. A qualified technician should perform all other service.
-  Before servicing the oven, remove power at the fusebox or circuit breaker.
- 
  - Do not leave children unattended around the oven when it is in use.
  - Do not let children sit or stand on any part of the appliance.
  - Do not use the oven as a space heater.
  - Do not use water on grease fires. Turn off the oven to contain the flames. Smother the fire by closing the door, or use a dry-chemical, baking soda, or foam-type extinguisher.
  - Avoid scratching or striking the glass doors and control panel. Do not use the oven if the door glass is damaged.

- 
- ☒ • If there is a fire in the oven during self-cleaning, turn the oven off, and wait for the fire to go out. Do not force the door open. Introducing fresh air at self-cleaning temperatures may cause a burst of flame from the oven.
  - Oil buildup in the oven chamber is a fire hazard. Check periodically, and if you notice oil buildup, wipe up the oil with a paper towel or rag, then run a self-cleaning cycle before using the oven again.
  - ★ • Do not keep flammable material (gasoline, plastic, clothing, paper) near the oven.
  - Remove all packing material before operating the oven.
  - Do not wear loose-fitting or hanging garments while using the appliance.
  - Use only dry potholders. Placing moist or damp potholders on hot surfaces may cause steam burns. Do not let the potholder touch hot heating elements. Do not substitute a towel or other bulky cloth for a potholder.
  - Do not let children play with any part of the oven.
  - Do not use high-pressure water cleaners or steam-jet cleaners on the oven.
  - A damaged power cord is an electric-shock hazard. Have the cord replaced by the manufacturer, its service agent, or an electrician.
  - The oven should not be operated by untrained users or anyone (including children) with reduced physical, sensory, or mental capacity, unless supervised by someone responsible for their safety.

# Safety information

---

## Electrical safety

---

- ☑ • Use only the factory installed flexible power cord to connect to the power supply.
- The oven should be serviced only by qualified personnel. Repairs by unqualified persons may cause injury and oven malfunction, and may void the warranty. For service, contact a Dacor-authorized center.
- A flush-mounted oven should be operated only if installed in cabinetry that conforms to accepted safety standards as instructed in this manual.
- If your oven malfunctions, or if fractures, cracks, or splits appear:
  - turn off and unplug the oven.
  - contact Dacor Customer Service (pg. 4).

### **⚠ WARNING**

Turn off the oven before replacing the lamp to avoid the possibility of electric shock.

## Child safety

---

### **⚠ WARNING**

- Children and infirm persons should only use the oven under the supervision of a responsible adult.
- Children should not be allowed to play with the oven.
- Keep children away from the oven door when opening or closing.
- During self-cleaning and even during normal use, oven surfaces get very hot. Keep children away from the oven during these times.

---

## Oven

---

- ☐ • DO NOT TOUCH THE HEATING ELEMENTS OR INTERIOR SURFACES. Heating elements may be hot even if dark in color. Interior surfaces become hot enough to cause severe burns. Do not touch or let clothing or other flammable materials touch the heating elements or interior oven surfaces unless those surfaces are cool to the touch. Other oven surfaces (e.g., oven vents and nearby surfaces, the oven door including the window) become hot enough to cause burns.
  - Do not heat sealed food containers. Pressure buildup may burst the containers.
  - Do not use the oven to dry newspapers.
  - Do not use the oven for storage.
- ★ • Open the oven door carefully to let out hot air or steam before removing food.
  - Do not line the oven chamber or racks with aluminum foil. Doing so causes inefficient heating and creates fire and electric-shock hazards.
  - To avoid a burn or fire risk, do not block the vents at the front base of the oven.
  - Always adjust the racks when the oven is cool. If a rack must be moved while the oven is hot, use potholders (keeping them away from the heating element).
- ☐ • Do not let aluminum foil or a meat probe touch the heating element.
  - Do not clean the oven door glass with abrasive cleaners or sharp metal scrapers. These can mar the glass, possibly causing it to shatter in the future.

### CAUTION

#### **Do not operate the oven during a power failure.**

If the power fails, turn the oven off. If the oven is on when power returns, the oven may begin to operate again. Forgotten food may catch fire or spoil.

# Safety information

---

## Self-cleaning ovens

---

- Do not clean the door gasket.** The door gasket is essential for a good seal. Care should be taken not to rub, damage, or move the gasket.
- Fumes released during a self-clean cycle may be harmful or fatal to birds. Move birds to a well-ventilated room.
  - Before self-cleaning the oven, remove the divider, rack, utensils, and any food, and wipe away grease and food soil. (Excess grease may ignite, causing smoke damage to your home.)
  - Do not use commercial oven cleaner or oven protective coating anywhere on the oven.
  - If self-cleaning mode malfunctions, turn the oven off, and disconnect the power supply. Have the oven serviced by a qualified technician.

## Critical usage warning

---

### **CAUTION**

- If the oven is flooded by any liquid, call Dacor Customer Service (pg. 4). Failure to do so may result in electric shock or fire.
  - If the oven emits a odd noise, burning smell, or smoke, unplug it immediately, and contact Dacor Customer Service. Failure to do so may result in electric shock or fire
  - During use, do not touch the oven door, heating elements, or any hot surfaces.
  - If material in the oven ignites, keep the oven door closed, turn off and unplug the oven, or shut off power at the fuse or circuit-breaker panel.
  - Care remove the wrapping from hot food. Steam may billow out.
- Do not repair, disassemble, or modify the oven. For repair assistance, call Dacor Customer Service (pg. 4).

**This page left blank  
intentionally**

**This page left blank  
intentionally**

- 
- ☐ • Do not touch the power cord with wet hands.
  - Do not turn the oven off while an operation is in progress.
  - Do not insert fingers, foreign substances, or metal objects such as pins or needles into slots or holes in the oven.
  - Do not modify the oven's construction or remove its outer shell.
  - Do not store or use the oven outdoors.
  - Use the oven only for cooking tasks consistent with residential use.
  - Do not heat sealed containers or food items with shells (eggs, nuts) in the oven.
  - Do not heat plastic or paper containers/wrapping in the oven.
  - Do not strike the door or the oven chamber.
  - Do not hang on, slam, or yank the door. If the door is damaged, do not use the oven. Call Dacor Customer Service (pg. 4).
  - Use oven mitts to touch cookware and oven surfaces during and just after cooking.

# Safety information

---

## Usage cautions

---

### CAUTION

-  • Oven-heated cookware is hot enough to burn. Handle with care.
- In removing coverings from hot cookware, direct steam away from exposed skin.
- Remove lids from baby food jars before heating. Afterward, stir the food well to distribute the heat evenly. Always taste-test the temperature before feeding the baby. The glass jar or the surface of the food may appear cooler than the interior, which can be hot enough to burn an infant's mouth.
- Take care when heating liquids such as water or other beverages.
- Avoid using a slippery container with a narrow neck.  
Wait at least 30 seconds after heating before removing the heated liquid. Failing to do so may result in an abrupt overflow of the contents and cause burns.
-  • Do not operate the appliance with wet hands.
- Do not spray volatile substances such as insecticide onto the surface of the appliance.
- Keep your face and body out of direct exposure to the heat when opening the door during cooking.
- Keep children away from the oven during cooking.
- Do not abruptly cool the door, oven chamber, or cookware by pouring water on/ in it during or just after cooking.
- Do not heat the oven while empty except for self-cleaning.
- Do not defrost beverages in narrow-necked bottles. The bottles can break.
- Do not let the food in the oven touch the heating element.
- Do not overheat food. Overheating food may result in fire.
- Take care not to pinch fingers or hands when opening or closing the door.
- The door reveals wires at the bottom for connecting LED lights. Take care not to damage the wires when handling the door.

---

## Critical cleaning warnings

---

### CAUTION

-  • Do not spray water directly on the oven.
- Do not use substances such as benzene, thinner, or alcohol to clean the appliance. Discoloration, deformation, electric shock, or fire may result.
- When cleaning, take care not to injure yourself on the oven's sharp edges.
- Do not clean the oven with a steam cleaner, which may corrode metal parts.
- Keep the oven chamber clean. Food residue can mar the finish and reduce oven inhibit oven function.

# Introducing your new oven

## Overview

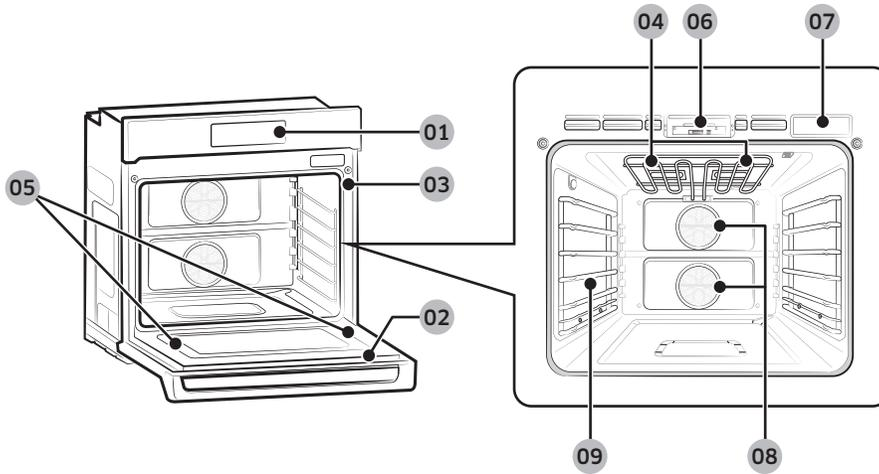

- |                       |                      |                 |
|-----------------------|----------------------|-----------------|
| 01 Oven control panel | 02 Oven door         | 03 Oven gasket  |
| 04 Halogen lamp*      | 05 Door LED light    | 06 Door latch   |
| 07 Water reservoir    | 08 Convection filter | 09 Rack support |

## What's included with your oven

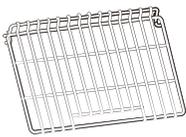

Wire racks (1)\*

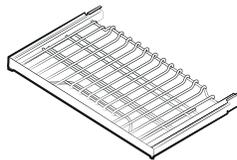

Gliding rack (2)\*

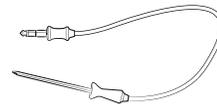

Temp probe (1)\*

### NOTE

Accessories marked with an \* can be purchased from Dacor Customer Service.

# Operations

## Control panel

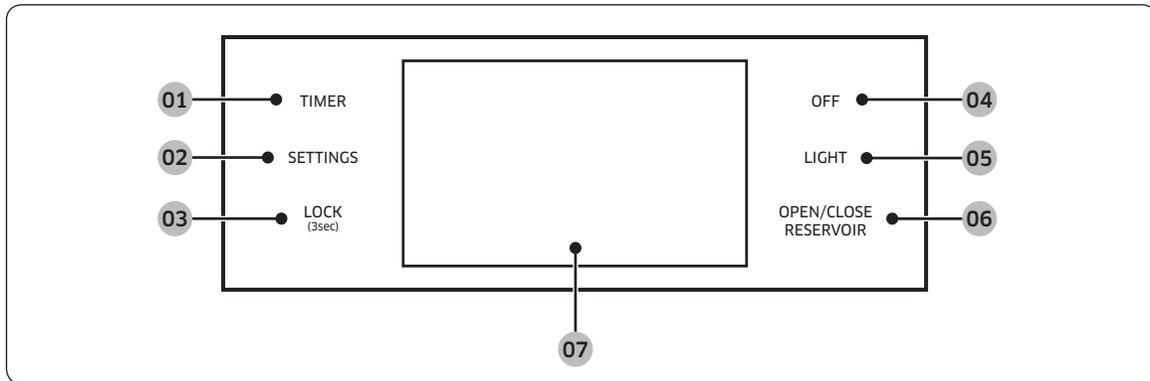

- 01** **TIMER**: Use to display the set Timer screen.
- 02** **SETTINGS**: Use to display the Setting screen.
- 03** **LOCK (CONTROL LOCKOUT)**: Press-hold for 3 seconds to disable all oven functions.
- 04** **OFF**: Use to cancel when oven is cooking.
- 05** **LIGHT**: Use to turn the oven light on or off.
- 06** **OPEN/CLOSE RESERVOIR**: Touch to open or close the water reservoir.
- 07** **Display**: Swipe to navigate the menus and tap to select a desired setting.

### NOTE

You cannot operate the display while wearing gloves/mitts. Always touch the display with a bare finger.

# Operations

## Display

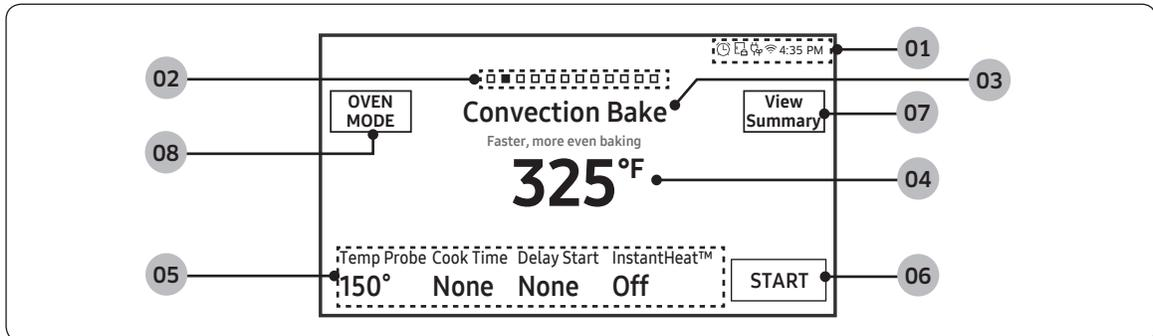

### 01 Indicator area

- **Timer** (⌚): When the timer is set, the timer indicator is displayed.
- **Door lock** (🔒): Displayed when the oven door is locked.
- **Wi-Fi** (📶): Shows Wi-Fi signal strength. If Wi-Fi is disconnected, ~~📶~~ is appears.
- **12-hour energy saving** (🔌): Displayed when 12-hour energy saving is turned on.
- **Current time**: The current time is displayed.

**02 Page indicator**: Shows location of current mode.

**03 Mode**: The current or selected menu is displayed with a mode description.

**04 Temperature**: The current or selected temperature is displayed. When you tap this area, the temperature adjustment screen is displayed.

### 05 Information area

- **Temp Probe**: Tap to show the Temp Probe screen.
- **Cook Time**: Tap to show the Cook Time screen.
- **Delay Start**: Tap to show the Delay Start screen.
- **InstantHeat™**: Shows that InstantHeat™ is on/off. (Convection Bake, Convection Roast modes only.)
- **Steam**: Tap to show the Steam Level screen. (Steam Bake, Steam Roast modes only.)

**06 START**: Tap to start the oven using the displayed settings.

**07 View Summary**: Tap to display the oven's cooking modes.

**08 OVEN MODE**: Tap to select an oven mode.

---

## Water reservoir

---

The reservoir is used in Steam Bake and Steam Roast modes and to remove water scale left on the oven walls after steam-cooking modes.

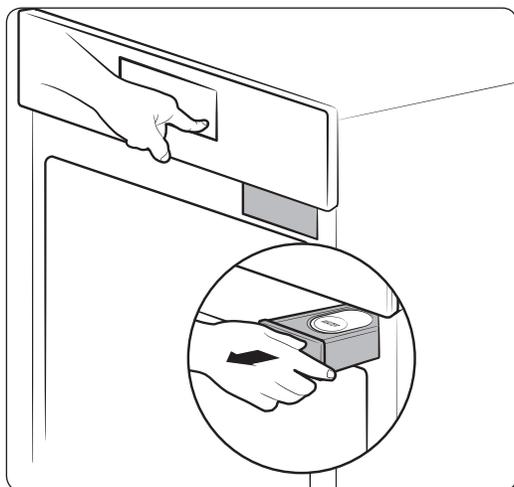

1. Open the oven door. The reservoir is on the right-hand side of the oven above the oven opening. On the control panel, touch **OPEN/CLOSE RESERVOIR**. The reservoir ejects. Pull the reservoir from its slot.

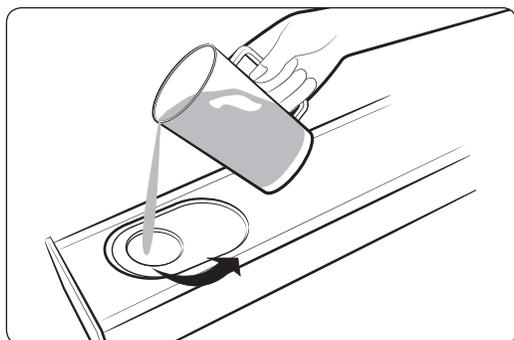

2. Open the reservoir cap, and fill it with 22 oz (650ml) of drinkable water.

 **NOTE**

You could also remove the rubber cap.

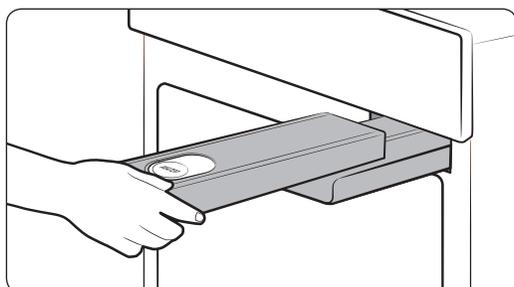

3. Replace the cap (or plastic top), and slide the reservoir into its slot. A soft click indicates it is seated correctly.
4. Touch **OPEN/CLOSE RESERVOIR**. The oven retracts the reservoir.
5. Close the oven door.

# Operations

---

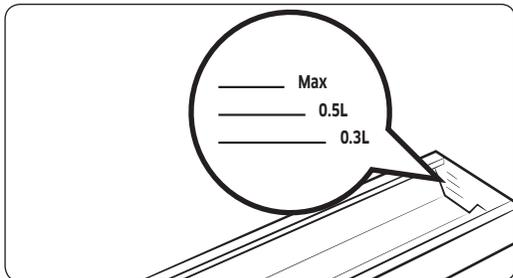

 **NOTE**

Do not exceed the max line.

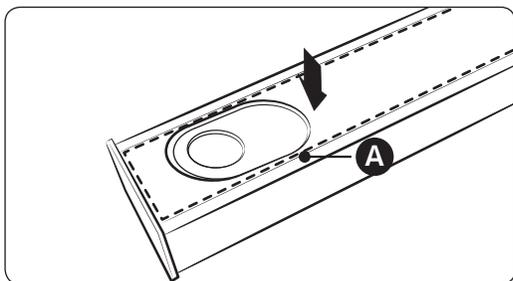

 **NOTE**

Close the cap and top portion of the reservoir (A) before using the oven.

 **CAUTION**

The reservoir heats up during cooking. Wear oven mitts to remove/refill the reservoir.

## Control lockout

Control lockout lets you lock touchpad buttons to prevent undesired changing of the controls. This feature also locks the oven door(s). Control lockout must be activated when the oven is in Standby mode.

### How to activate Control Lockout

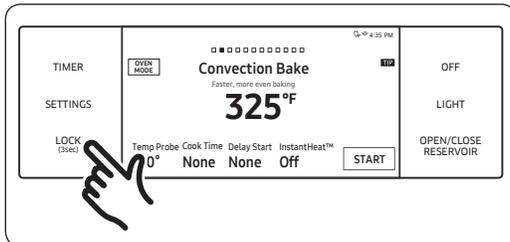

1. Cancel or turn off all functions.
2. Touch **LOCK** for 3 seconds.

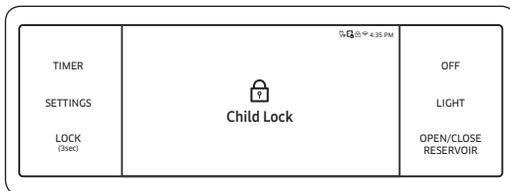

- The display changes to the Child Lock screen, and the control lock confirmation appears at the bottom of the screen.

### NOTE

- Control Lockout is available only when the oven temperature is under 400 °F.
- All other functions must be cancelled before you activate Control Lockout.

### How to unlock the controls

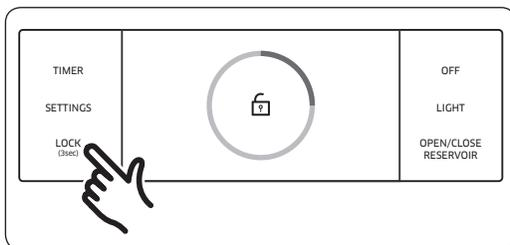

1. Touch **LOCK** for 3 seconds. The control lock confirmation and the lock icon disappear.

### NOTE

It may take up to 10 seconds for the doors to unlock.

# Operations

## Kitchen timer

This timer beeps when the set time elapses. It does not start/stop cooking functions. You can use the kitchen timer with any oven function.

### How to set the timer



1. Touch **TIMER**. The display changes to the timer screen.

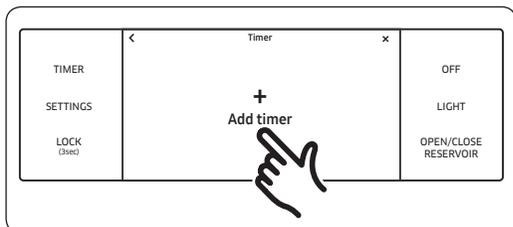

2. Tap + Add timer.

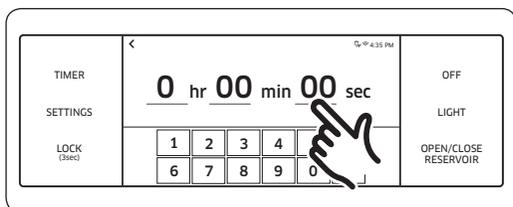

3. Tap the numbers on the touchpad to set the time (from 1 sec to 23 hr 59 min 59 sec).

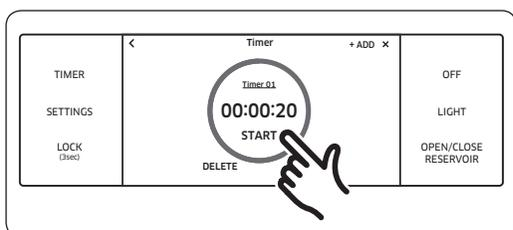

4. Tap **START**. When the time elapses, the oven beeps, and the display shows the timer has finished.

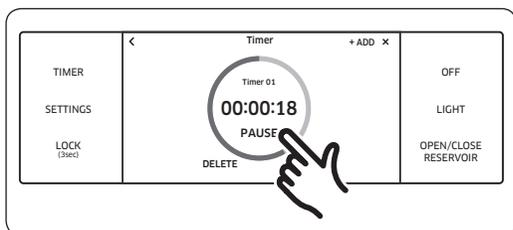

- You can pause, reset, or delete the timer at any time by touching the screen.

### How to change timer name

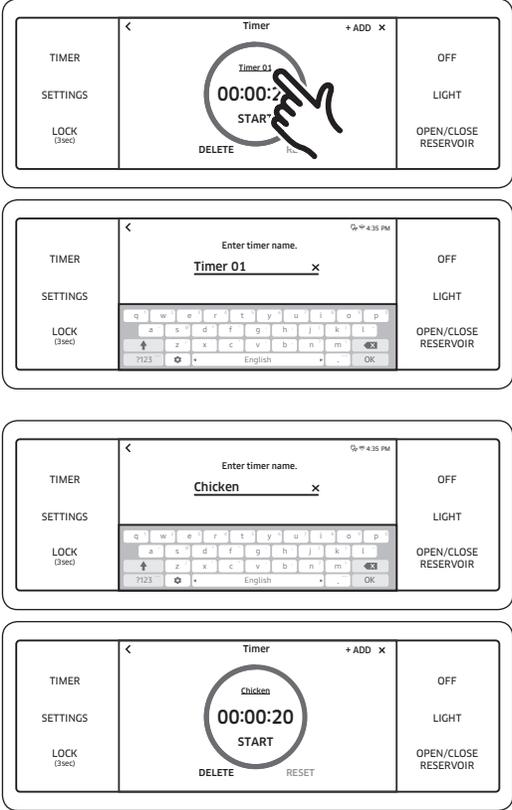

You can change the timer name to identify what you are timing, for example, a chicken defrosting.

1. Tap the timer name area.
  - The keyboard appears.

**NOTE**

- You can name the timer in a max of 13 characters.

2. Tap the keyboard to set the new timer name.
  - The display shows the changed timer name.

# Operations

## Timed cooking

In this mode, the oven turns on immediately and cooks for the length of time you set. At the end of the cooking time, the oven turns off automatically.

You can use Timed Cooking only with another cooking mode (Bake, Convection Bake, Convection Roast, Pure Conv. Sear, Convection Broil, Steam Bake, Steam Roast, Dual Four Part Pure Convection, Proof, Stone Bake Mode, Dehydrate).

### How to set the oven for timed cooking



1. Swipe to the desired cooking mode.
2. Tap **Cook Time**. The display changes to the Set Cooking Time screen.

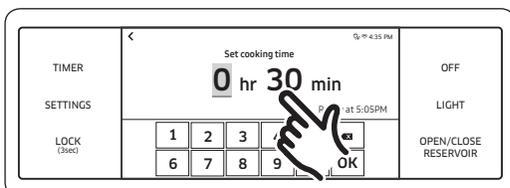

3. Tap numbers on the touchpad to set the cooking time (from 1 min to 9 hr and 59 min).

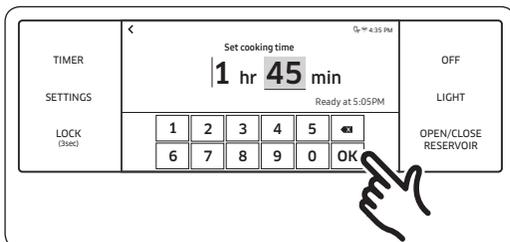



- The cook time appears in the Cook Time area of the screen.
- Cancel the cook time at any time by setting the Cook Time to 0 minutes.

### CAUTION

You can use timed cooking and delay start to cook cured or frozen meats, and most fruits and vegetables.

Food that spoils easily (e.g., eggs, fish, meat, poultry) should be chilled in the refrigerator first. Even so, it should sit in the oven no longer than 1 hour before cooking starts and should be removed promptly when done.

Eating spoiled food can cause food poisoning.

# Operations

## Delay start

In this mode, the oven timer turns the oven on at your preset time. At the same time, you can set the oven to turn off automatically via the Timed Cooking function.

- You can use Delay Start only with another cooking operation (Bake, Convection Bake, Convection Roast, Pure Conv. Sear, Steam Bake, Steam Roast, Dual Four Part Pure Convection, Proof, Stone Bake Mode, Dehydrate, Self clean, GreenClean™).
- You can set Delay Start before setting other cooking operations.
- The oven clock must be set to the current time.

### How to set the oven for delay timed cooking

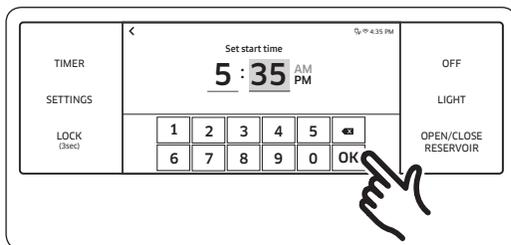
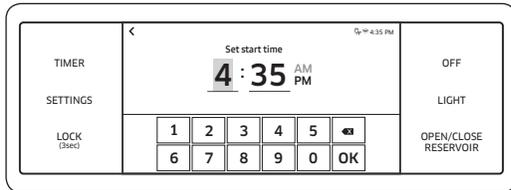

1. Place the food in the oven.
  2. On the control screen, swipe to the desired cooking operation.
  3. Set the cook time if you want the oven to turn off automatically. (See **Timed cooking**, pg. 26.)
  4. Tap **Delay Start**. The current time appears as the first entry.
  5. Tap numbers on the touchpad to set the oven start time.
- The Delay Start screen closes. The start time (and, if you set it) the cook time are displayed.

---

## Using the oven racks

---

### Oven rack levels

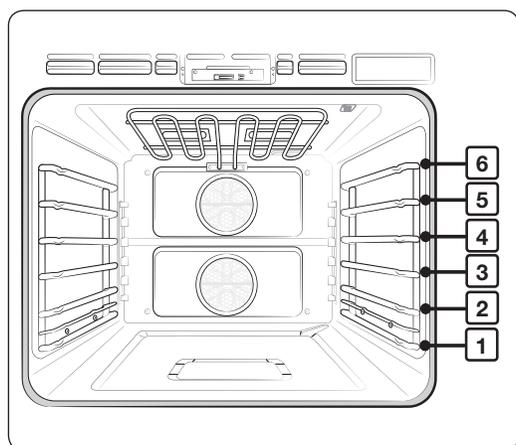

Recommended rack levels for cooking

TYPE OF FOOD	RACK LEVEL
Broiling hamburgers	6
Broiling meats or small cuts of poultry, fish	3-5
Bundt cakes, pound cakes, frozen pies, casseroles	3 or 4
Angel-food cakes, small roasts	2
Turkeys, roasts, hams, fresh pizza	1

This table is for reference only.

# Operations

---

## Rack and pan placement

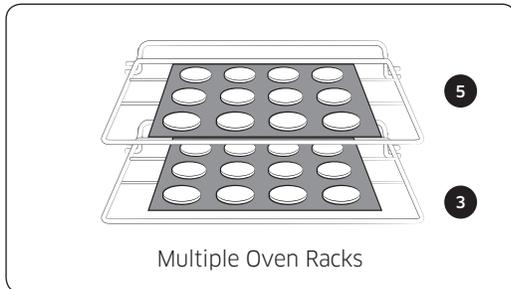
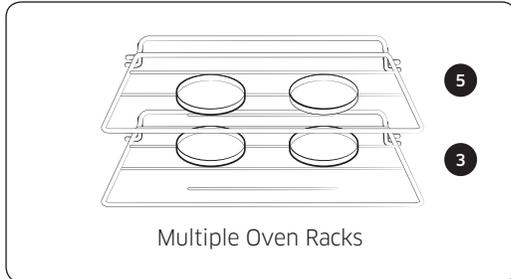

- Center baking pans if possible to improve results. If using multiple pans, leave 1" to 1½" of space around them.
- using one oven rack, place it at Level 3 or 4 (graphic, pg. 29).
- When baking cakes/cookies on multiple racks, place the racks at Levels 3 and 5.

---

### Before using the racks

Each rack has stops that must be placed correctly on the supports so the rack cannot be accidentally pulled from the oven.

### Removing the racks

1. Pull the rack straight out until it stops.
2. Lift up the front of the rack, and then pull it out.

### Replacing the racks

1. Place the end of the rack on the support.
2. Tilt the front end up and push the rack in.

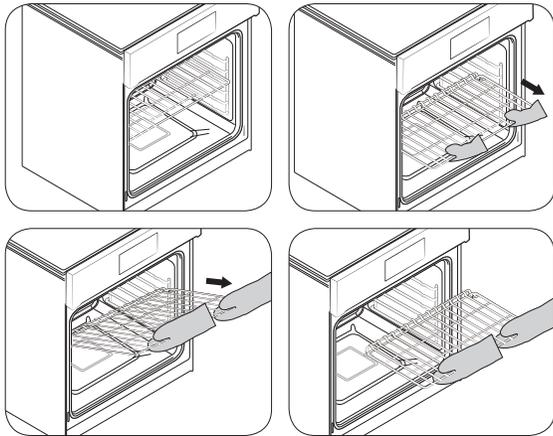

### ⚠ CAUTION

- Do not line the racks or oven chamber with aluminum foil. Doing so impedes heat circulation, causes poor results, and may harm oven-chamber surfaces.
- Arrange the oven racks only when the oven is cool.

# Operations

---

## Using the gliding rack

---

This fully extendable rack has glide tracks that let you extend the rack fully out of the oven for safe placement and removal of cookware (especially heavy dishes).

## Installing the gliding rack

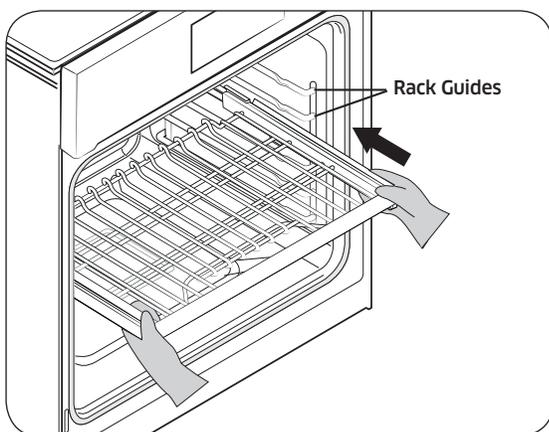

- With the rack glides retracted and the oven off, carefully insert the rack between the guides until the rack reaches the back of the oven chamber.

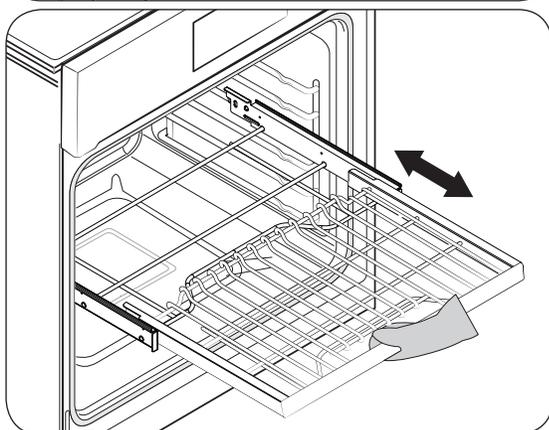

- Grasp the handle to slide the rack in/out. (If you grasp either side of the handle, the rack may come loose.)
- Use oven mitts to handle the gliding rack when cooking.

---

## Removing the gliding rack

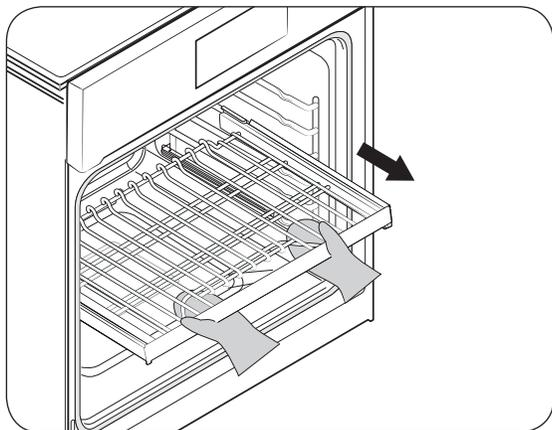

- With the rack fully in and the oven off and cool, grasp the rack and frame, and pull outward and off the guides.

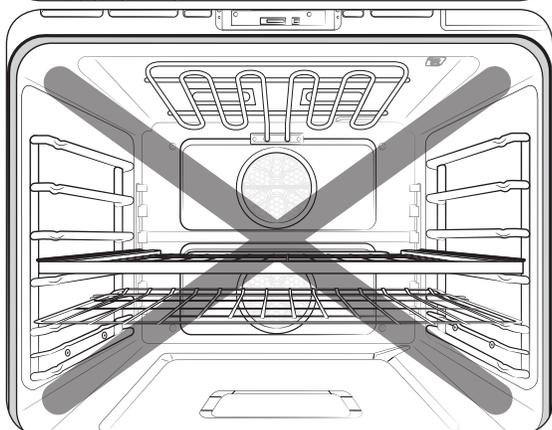

**⚠ CAUTION**  
Do not place the gliding rack one level above a wire rack. The gliding rack will not seat properly and may fall.

**📄 NOTE**

You can install the gliding rack at any level except 1 (bottom).

# Operations

## Using the temp probe

For many foods, especially roasts and poultry, measuring internal temperature best determines proper doneness. The temp probe lets you cook meat with exactness.

Once the food's internal temperature reaches 100 °F (37.7 °C), the current internal temperature appears on the display.

### How to use the temp probe

1. Push the tip of the temp probe into the meat as fully as possible, so that the tip is in the center of the meat.

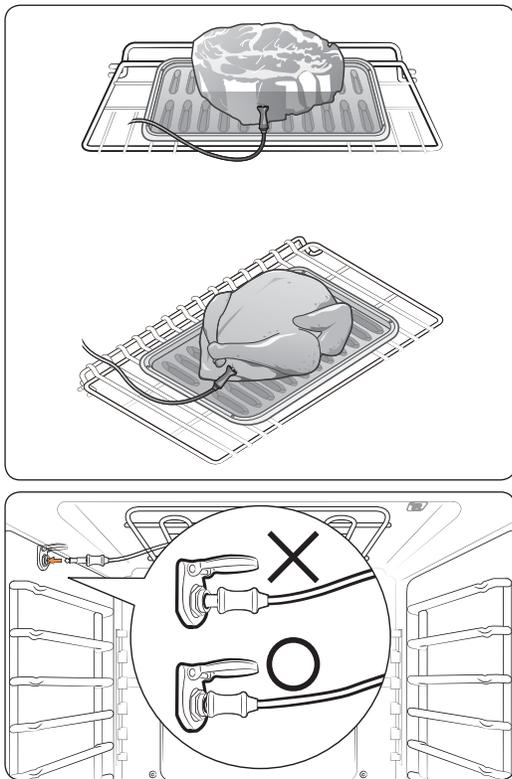

- Insert the probe completely into the meat (see left) without touching bone, fat, or gristle.
- If you do not fully insert the probe, it will sense the oven temperature; thus, the reading will not reflect the food's degree of doneness.
- For bone-in meats, insert the probe into the center of the lowest, thickest part of the piece.
- For whole poultry (turkey, chickens, etc.), insert the probe into the thickest part of the inner thigh, parallel to the leg.
- If you activate the Keep Warm function to keep the meat warm after cooking with the temp probe, the meat's internal temperature will exceed the intended "done" temperature.

- 
2. Plug the temp probe into the socket on the top side wall of the oven (see pg. 34).
  3. On the control screen, swipe to the desired cooking operation (Bake, Convection Bake, Convection Roast, Pure Conv. Sear, Steam Bake, Steam Roast, or Dual Four Part Pure Convection), and set the oven temperature (see pg. 42).
  4. Tap **Temp Probe**, and use the number pad, set the desired internal temperature.

Available temperatures	100 °F to 200 °F
------------------------	------------------

6. (Optional) Set the Cook Time or Delay Start, and tap START.  
When the set internal temperature is reached, the probe sensor deactivates, and an alarm sounds.

 **CAUTION**

To protect the probe's tip, defrost the food fully, and ensure it does not protrude.

 **CAUTION**

- Do not store the probe in the oven or leave it there during a self-cleaning or broiling cycle. You can permanently damage the probe.
- Do not use tongs to insert/remove the probe.
- Use the temp probe only as instructed.

 **NOTE**

If you remove the temp probe while it is active or insert it while baking or cooking normally, cooking will stop after 1 minute.

If you use the probe to cook frozen food, it may not function. (The probe icon will not appear on the control screen.)

# Operations

---

## Temp probe table

Type of Food		Internal temperature
Beef / Lamb	Rare	140 °F
	Medium	160 °F
	Well done	170 °F
Pork		170 °F
Poultry		180 - 185 °F

### NOTE

If you cover the meat with aluminum foil and allow it to stand for 10 minutes after cooking, the Internal temperature will rise 5-10 degrees.

### Removing the temp probe

Remove the temp probe plug from the socket.

### CAUTION

After cooking, the Temp probe is hot enough to cause burns. Let it cool sufficiently before attempting to remove it.

---

## Oven functions

---

### Cooking mode

Swipe to select the cooking mode. Set the temperature you want. See **Setting the Temperature** on pages 42 and **Basic Baking and Broiling Instructions** starting on page 42.

Mode	Temperature range	Temp probe	InstantHeat™
Bake	175 °F (80 °C) - 550 °F (285 °C)	0	-
Convection Bake	175 °F (80 °C) - 550 °F (285 °C)	0	0
Convection Roast	175 °F (80 °C) - 550 °F (285 °C)	0	0
Broil	LO / HI	-	-
Pure Conv. Sear	175 °F (80 °C) - 475 °F (245 °C)	0	-
Convection Broil	175 °F (80 °C) - 550 °F (285 °C)	-	-
Steam Bake	230 °F (110 °C) - 550 °F (285 °C)	0	-
Steam Roast	230 °F (110 °C) - 550 °F (285 °C)	0	-
Dual Four Part Pure Convection	175 °F (80 °C) - 550 °F (285 °C)	0	-

0 = Available / - = Not Available

# Operations

Mode	Instruction
Bake	<ul style="list-style-type: none"> <li>• This is for cakes, cookies, and casseroles. Always preheat the oven.</li> <li>• Baking temps/times vary with ingredients and cookware size/shape.</li> <li>• Dark or nonstick coatings may cook faster with more browning.</li> </ul> <p> <b>NOTE</b> Convection baking: It is normal for the fan to turn on/off during baking.</p>
Convection Bake	<ul style="list-style-type: none"> <li>• Uses a fan to circulate oven heat evenly and continuously.</li> <li>• Better heat distribution provides even cooking and excellent results, even for multi-rack use.</li> <li>• Breads and pastries brown more evenly.</li> </ul>
Convection Roast	<ul style="list-style-type: none"> <li>• Good for cooking large, tender cuts of meat uncovered; the fan circulates oven-heated air evenly all around the food.</li> <li>• Meat and poultry are browned on all sides as if rotisserie-cooked.</li> <li>• Juices are sealed in quickly for moist, tender results and richly browned meat.</li> </ul>
Broil	<ul style="list-style-type: none"> <li>• For cooking tender cuts of meat, fish, and poultry up to 1" thick by direct heat.</li> <li>• High heat cooks quickly, providing a rich, brown exterior.</li> <li>• Always preheat the oven for 5 minutes.</li> <li>• See <b>Broiling recommendation guide</b>, pg. 40.</li> </ul>
Pure Conv. Sear	<ul style="list-style-type: none"> <li>• Uses the convection element and fan</li> <li>• Best for game hens, chickens, stuffed/unstuffed turkeys, turkey breasts, pork tenderloin, and pork-loin roasts.</li> <li>• For the first 15 minutes, meat is cooked 75 °F (42 °C) higher than the set temp to trap the meat's natural juices.</li> </ul>

Mode	Instruction
Convection Broil	<ul style="list-style-type: none"> <li>• Similar to Broil, but with air circulation by oven fan.</li> <li>• In this mode, the broil element cycles on and off to maintain oven temperature, while the fan circulates hot air.</li> <li>• For gentle browning and trapping of natural juices of thicker cuts of meat, fish, and poultry.</li> <li>• For optimum browning, preheat for 5 min.</li> </ul>
Steam Bake	<ul style="list-style-type: none"> <li>• For baking breads, pastries, and desserts; increases moisture content and improves texture/flavor.</li> <li>• See <b>Steam cook recommendation guide</b>, pg. 40.</li> </ul>
Steam Roast	<ul style="list-style-type: none"> <li>• For roasting meats and poultry; maintains a crispy surface while trapping juices for a moist and tender result.</li> <li>• See <b>Steam cook recommendation guide</b>, pg. 40.</li> </ul>
Dual, Four-Part Pure Convection	<ul style="list-style-type: none"> <li>• Uses the convection element and fan.</li> <li>• Uniform air circulation lets you use more oven space.</li> <li>• For single-/multi-rack baking, roasting, and complete meals.</li> <li>• Many foods (e.g., pizza, cake, cookies, biscuits, muffins, rolls, and frozen convenience foods) can be prepared on 2-3 racks at a time.</li> <li>• Good for whole, roasted duck, lamb shoulder, short leg of lamb.</li> </ul>

# Operations

## Broiling recommendation guide

The size, weight, thickness, starting temperature, and doneness preference affect broil times. This guide is based on refrigerator-temperature meat. Always use a broil pan and grill when broiling. Preheat the oven for 5 minutes.

Food	Doneness	Size	Thickness	Level	Rack position	Cooking time (min)	
						1st side	2nd side
Hamburgers	Medium	9 patties	3/4"	Hi	6	3:00	2:00
	Medium	9 patties	1"	Hi	6	3:20	2:20
Beef steaks	Rare	-	1"	Hi	5	3:00-4:00	2:00-3:00
	Medium	-	1- 1 1/2"	Hi	5	4:00-5:00	3:00-4:00
	Well done	-	1- 1 1/2"	Lo	4	7:00-8:00	4:00-5:00
Chicken pieces	Well done	4.5 lbs.	1/2-3/4"	Lo	3	16:00-18:00	13:00-15:00
	Well done	2 lbs.	1/2-3/4"	Lo	3 or 4	15:00-16:00	10:00-12:00
Pork chops	Well done	1 lbs.	1"	Lo	3	8:00-10:00	6:00-8:00
Fish fillets	Well done	-	1/4-1/2"	Lo	3 or 4	7:00-8:00	4:00-5:00

## Steam cook recommendation guide

Steam mode	level	Foods
Steam bake	High	Rye breads, Desserts (Flan caramel)
	Med	Croissants, Pies, Reheats (Pizza, Casseroles)
	Low	Pastries
Steam Roast	High	-
	Med	Meats, Poultry, Fish
	Low	Turkey, Large meats

## Setting the mode

### Swipe the screen

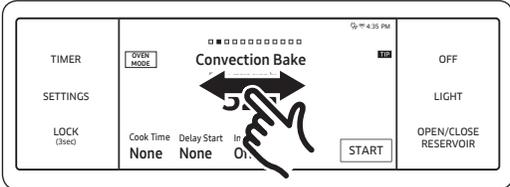

- Swipe the screen to select mode you want. (You can swipe left or right).

### Summarized mode

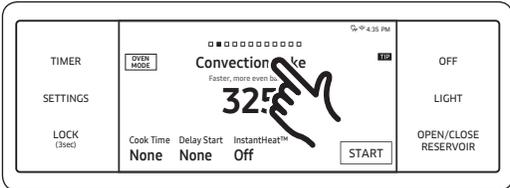

- Tap the mode area to display the summarized mode.

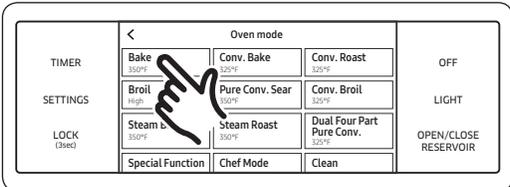

- Tap the mode you want.

# Operations

## Setting the temperature



- Tap the temperature area to display the numeric pad.
- Tap the numbers to set the temperature.
- Tap **OK**.

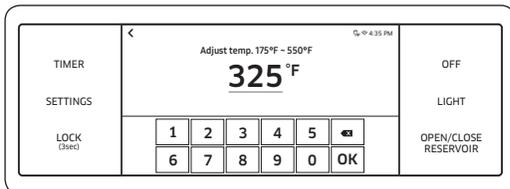

## Basic baking and broiling instructions

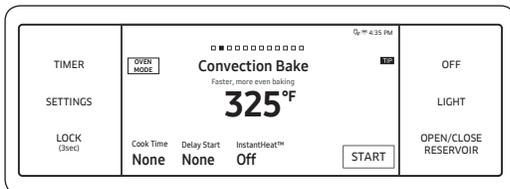

1. Swipe to select a cooking mode.



2. Set the temperature.
  - Broil mode can be set only Hi or Low.
  - The **Keep Warm** setting cannot be changed.

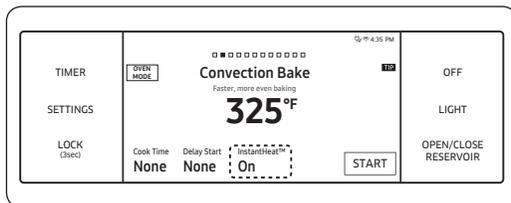

3. Follow the steps below to use the InstantHeat™ feature, Steam Bake, or Steam Roast. If you are not using these features, skip to Step 4, next page.

- **InstantHeat™**
  - a. If you select Convection Bake or Convection Roast, InstantHeat™ info appears on the display (default: OFF).
  - b. Tap the InstantHeat™ area. The InstantHeat™ feature activates; the display shows ON.

**NOTE**

For best performance, use one rack.

Type	Rack Positions
Baking	3 or 4
Roasting	1 or 2

- When using InstantHeat™, put food in the oven before you start cooking.
- For best performance, preheat the oven when baking rising foods (e.g., cake, muffins, puff pastries).

# Operations

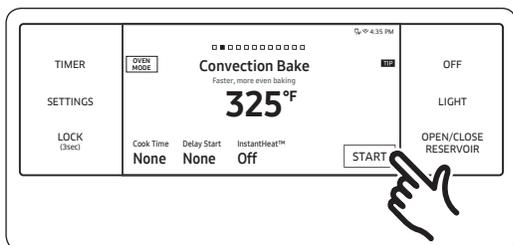
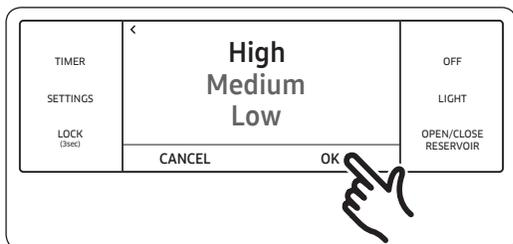
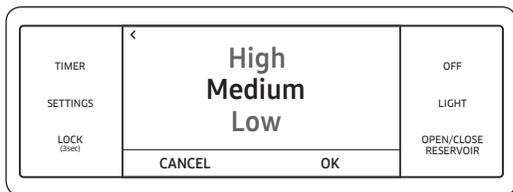
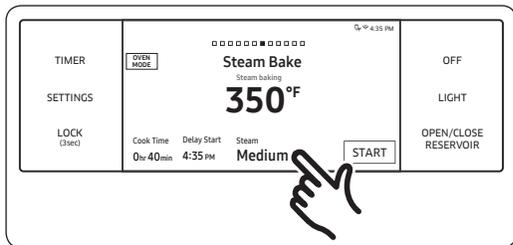

- **Steam Bake, Steam Roast**
  - a. If you select Steam Bake or Steam Roast, the steam-level info appears on the display (default: Medium).
  - b. Tap **Steam** to adjust the steam level. The steam-level adjustment screen appears. Set the steam level (Low, Medium, or High).
    - c. Tap OK. The steam-level adjustment screen closes; the steam-level info appears on the screen.
 

**Important:** You must fill the water reservoir before start steam cooking. (See **Water reservoir**, pg. 21.)
- If you want to use Cook Time or Delay Start, set them now. (See pgs. 26 and 28 for instructions.)
- Tap **START** to begin cooking.
  
- 6. Tap **OFF** when cooking is done or if you want to cancel cooking.

## How to adjust the temperature while cooking

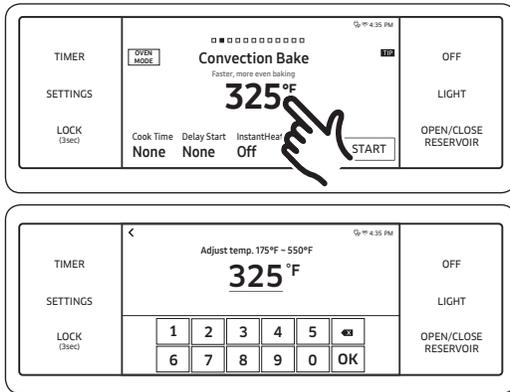

Tap the temperature area, enter the new temperature using the numeric keypad and then tap **OK**.

- ★ Place food in the oven after preheating if the recipe calls for it. Preheating is important for best results when baking cakes, cookies, pastry, and breads.
- The convection oven fan shuts off when the oven door is opened.
- DO NOT leave the door open for long periods of time while using convection cooking or you may shorten the life of the convection heating element.

### NOTE

- If you leave the oven door open over 2 minutes when it is on, all heating elements shut off automatically.
- When finished cooking, the cooling fan runs until the oven has cooled down.
- When a steam function is complete, empty the water reservoir so the remaining water does not affect other cooking modes.
- When using a thermometer in the oven chamber, the temperature on the thermometer may differ from the set oven temperature.
- It is normal for the convection fan to cycle on/off during cooking.
- Always keep the oven door closed when broiling.

# Operations

**⚠ CAUTION**

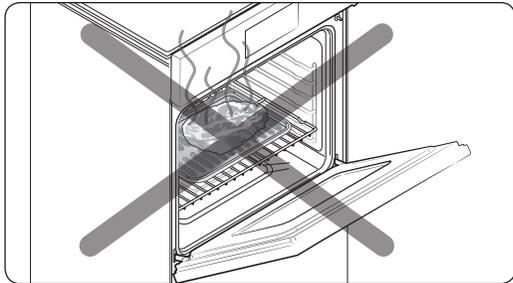

Always broil with the oven door closed. Use care when opening the door. Let hot air or steam escape before you remove food from or put food into the oven.

## Using the special function feature

Special function provides 4 different specialized cooking options.

Mode	Temperature range
Keep Warm	**None
Proof	95 °F (35 °C) / 105 °F (40 °C)
Stone Bake Mode	175 °F (80 °C) - 550 °F (285 °C)
Dehydrate	105 °F (40 °C) - 225 °F (105 °C)

\*\* A factory-set, non-adjustable temperature is applied for best performance.

Mode	Instruction
Keep Warm	<ul style="list-style-type: none"> <li>Keeps food warm for serving up to 3 hours after cooking.</li> <li>Can be used without any other cooking operations, or you can set it to activate after a timed or delay timed cooking operation.</li> <li>Not for reheating cold food.</li> </ul>
Proof	<ul style="list-style-type: none"> <li>Provides optimal temp (95 °F / 105 °F) for proofing bread dough.</li> <li>For the best results, always start the Proof option with a cool oven.</li> </ul>
Stone Bake Mode	<ul style="list-style-type: none"> <li>Stone accessory required.</li> <li>Bake on a baking or pizza stone for pizza and bread.</li> <li>Always preheat with a stone for the best results.</li> </ul>

Mode	Instruction		
Dehydrate	<ul style="list-style-type: none"> <li>Dries food via heat circulation.</li> <li>Keep dehydrated food in a cool, dry place.</li> <li>Adding lemon or pineapple juice, or sprinkling sugar on fruit helps retain sweetness.</li> <li>Dehydrate mode settings:</li> </ul>		
	Category	Rack position	Temperature (°F)
	Vegetables or Fruit	3 or 4	105-150
	Meat	3 or 4	145-225

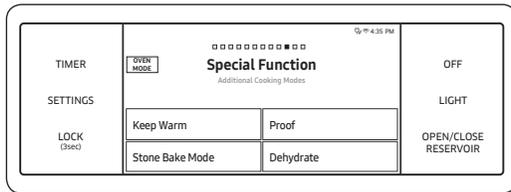

1. Swipe the screen to the **Special** function. The display will show the specialized cooking options.

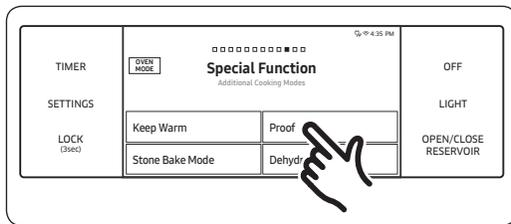

2. Tap the cooking option you want.

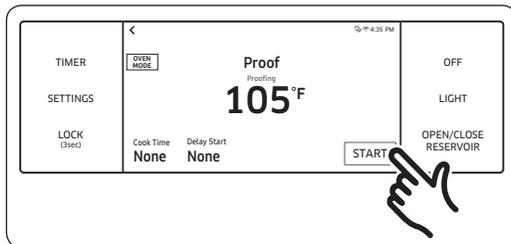

3. Set the temperature you want.

4. Tap **START**.

**NOTE**

You cannot adjust the temperature of the Keep Warm mode.

# Operations

---

## CAUTION

- If the oven temperature is above 125 °F, Proof mode will not function properly.
- Do not use Proof to warm food. (The temperature is insufficient to keep food warm.)
- Put the dough in a heat-safe container, cover it with a cloth or plastic wrap, and place it on rack Level 3 or 4. (Fix the covers so the oven fan cannot blow them off.)
- So as not to lower the temperature and prolong proofing, leave the oven door closed.

## NOTE

- Preheating is unnecessary for special functions except Stone Bake mode.
- An error beep sounds if the temperature setting is out of the set range.

### Rack position chart for special cooking options

Mode	Rack position
Keep Warm	3
Proof	3
Stone Bake Mode	1 or 2
Dehydrate	3 or 4

## Using the Chef Mode feature

This mode offers 15 recipes that will save time and shorten the learning curve for novice cooks. Cook time and temperature automatically adjust to the selected recipe. You can download detailed recipes for each dish from [www.dacor.com](http://www.dacor.com).

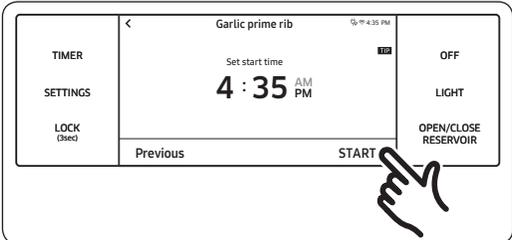
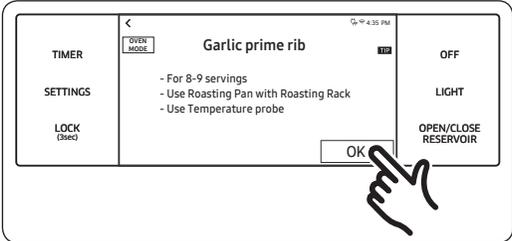
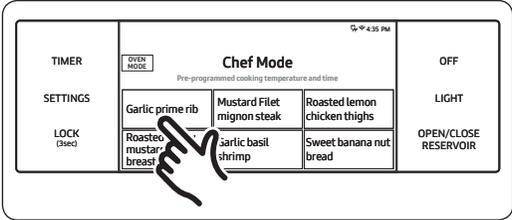
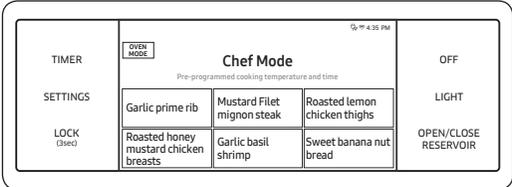

1. Swipe the screen to **Chef Mode**. 15 auto-cook features appear. (You can scroll down through the list.)
2. Scroll through the list, and tap the desired feature.
3. Follow the on-screen instructions.
4. Tap **START** to start cooking.

# Operations

## Cooking tips in the Chef Mode



1. Tap **TIP** to see a cooking tip.

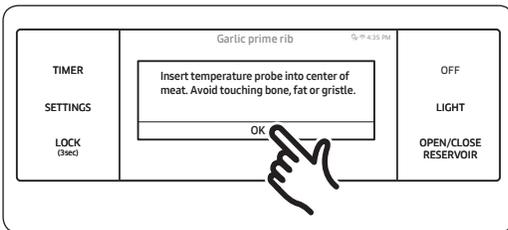

2. The display will show the cooking tip. You can see the cooking tip before you start cooking or while you are cooking.

## Using the iQ control feature

To use the oven's iQ Control feature, you must download the Dacor iQ Kitchen app to a mobile device. Functions that can be operated via this app may not work well if there are communications conflicts or the Wi-Fi signal is weak.

This table lists the main functions that can be operated from the app:

When iQ Control on the oven is off:	Monitoring (Oven, Probe), Oven off
When iQ Control on the oven is on:	Monitoring (Oven, Probe), Oven start, Oven off, Error check

## How to connect the oven

1. Download and open the Dacor iQ Kitchen app on your smart device.
2. Follow the app's on-screen instructions to connect your oven.
  - The connected  icon on your oven appears; the app confirms you are connected.
  - If the connection icon does not appear, follow the directions in the app to reconnect.

---

## To start the oven remotely

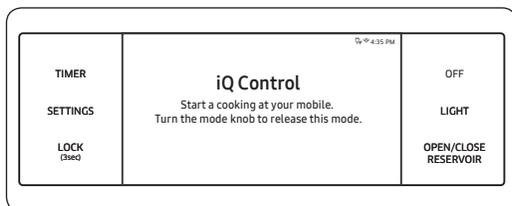

Tap **SETTINGS** > **Connections** > **iQ Control**, and then tap **ON**.

### When iQ control is on you can remotely:

- Turn on/off the oven.
- Change cook mode, time, and temperature once cooking starts.

#### **NOTE**

Important: Self-clean mode cannot be started remotely.

#### **NOTE**

- Opening the oven door deactivates iQ Control so you cannot control the oven remotely, except for monitoring oven status and turning the oven off.
- When cooking is finished or cancelled, iQ Control deactivates.

# Operations

---

## Using the clean feature

---

The Clean feature has four selections: Self-Clean, GreenClean™, Descale, and Draining.

### Self clean

This self-cleaning oven uses high temperatures (well above cooking temperatures) to reduce food residue to a fine powder that you can wipe away with a damp cloth.

### CAUTION

- During and for some time after self-cleaning, the outside of the oven is very hot. Do not allow children near the oven.
- The fumes emitted during self-cleaning are harmful to pet birds. Move birds to another well-ventilated room.
- The oven door locks during self-cleaning. Forcing the door open will likely damage the automatic door lock. When self-cleaning is complete, stand to the side when opening the door so hot air and steam can safely escape.

## Self clean

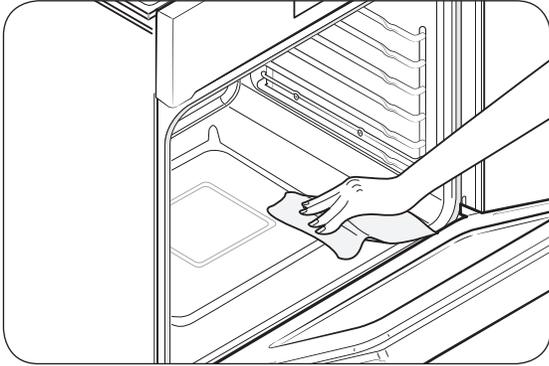

Fig. 1

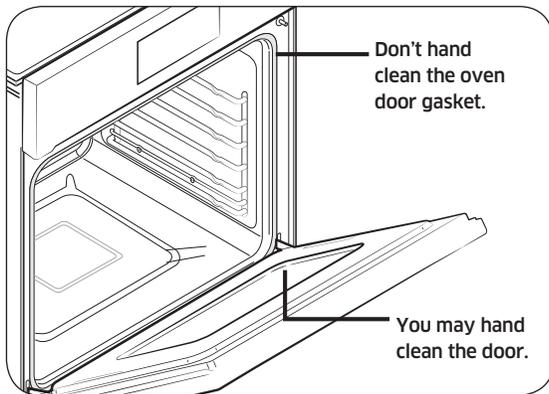
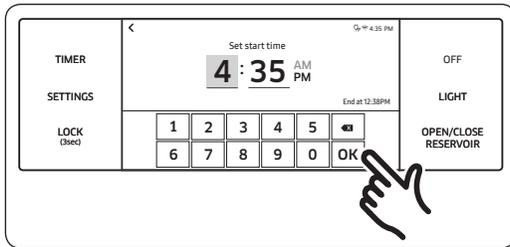

Fig. 2

- Ventilate the kitchen by opening a window and even using a fan or hood during the self-cleaning cycle.
- Remove the racks, rack supports, broil pan, broil-pan insert, and cookware.
- Wipe down the oven floor (Fig. 1).
- The oven racks can be self-cleaned, but they will darken, lose their luster, and become hard to slide.
- Clean residue on the front frame and outside the door gasket by hand with hot water, soap-filled steel-wool pads, or cleansers such as Soft Scrub. Rinse well with clean water and dry.
- Do not clean the gasket (Fig. 2). The fiberglass material cannot withstand abrasion. The gasket to remain intact. If it becomes worn, have it replaced.
- Make sure the oven light cover is in place and the oven light is off.





- Set the time you want self-cleaning to start, and then tap **OK**.



- Tap **START** to begin self-cleaning. The motor-driven door lock will engage automatically.

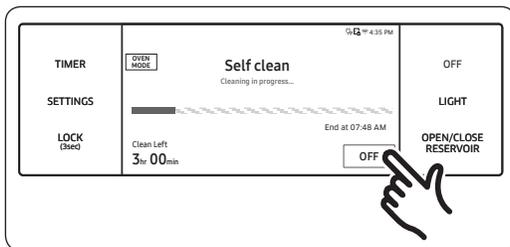

- If you need to stop or interrupt a self-cleaning cycle, tap **OFF**.

#### NOTE

- You cannot start a self-cleaning cycle if the control lockout feature is active or the oven is too hot.
- The oven door locks automatically. The display shows the cleaning time remaining. You cannot open the oven door until the temperature drops to a safe level.

#### After a self-cleaning cycle

- Wipe up any ash with a damp cloth after the oven cools. (Remove any white spots with a soap-filled steel wool pad and rinse thoroughly with a vinegar-water solution.)
- If the oven is not clean after one cycle, repeat the cycle.
- You cannot set the oven to cook until the oven is cool enough for the door to unlock.

# Operations

## GreenClean™

This function saves time and energy by removing leftover grease and residue that you can wipe away with a damp cloth.

### NOTE

The oven door locks during Green cleaning. Forcing the door open will likely damage the locking system. After a Green cleaning cycle, stand to the side of the oven when opening the door so hot air and steam can escape safely.

### How to run a Green cleaning cycle

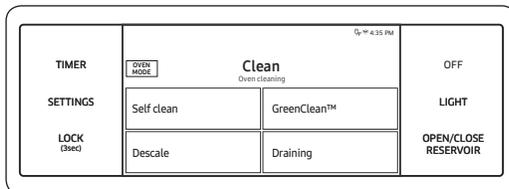

1. Swipe the screen to **Clean**. The display will show 4 cleaning selections.

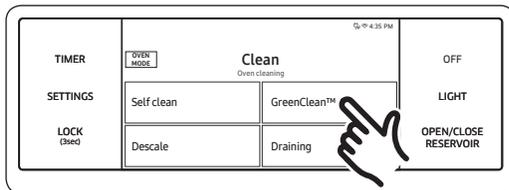

2. Tap **GreenClean™**.



3. Tap **START** to begin Green cleaning.

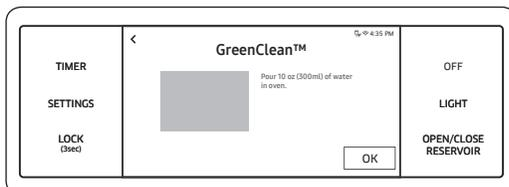

4. Follow the on-screen instructions. Green-cleaning will start automatically.



5. After the Green-cleaning cycle, there will be a significant amount of water on the oven floor. Wipe up the water with a sponge or soft, dry cloth. (Wipe also the oven face below the door seal.)

#### NOTE

- For Green-cleaning, exactly 10 oz (300 ml) of water produces the best results.
- Green-cleaning will not function if Control lockout is active or the oven is too hot.

#### After a Green-cleaning cycle

- Open the door carefully, avoiding hot air and steam. The water on the floor is hot.
- With a detergent-soaked sponge, soft brush, or nylon scrubber, wipe the oven chamber. Remove stubborn residue with a nylon scourer. Remove lime deposits with a cloth soaked in vinegar.
- If significant residue remains, you can repeat the process once the oven is cool.
- For heavy residue, such as grease left over from roasting, rub detergent into the residue before starting Green-cleaning.
- After cleaning, leave the oven door ajar 15°, and let the oven chamber dry thoroughly.

# Operations

## Descal

If you use Steam Bake or Steam Roast frequently, you should regularly remove mineral deposits that may affect the taste or quality of food. When running a descaling cycle, use only descaling agents designed for steam ovens or coffee machines.

### NOTE

If you use Steam Bake/Steam Roast functions for more than 12 total hours, the Descal indicator turns on. You can still enable Steam Bake or Steam Roast for two more hours without descaling. When those two hours are up, Steam Bake and Steam Roast will be disabled until you have run a descaling cycle.

### How to run a descale cycle

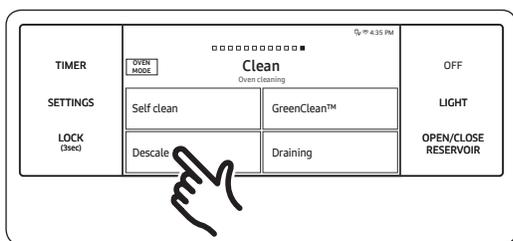

1. Swipe the screen to **Clean**. The display will show 4 cleaning selections.

2. Tap **Descal**.



3. Tap **START**.

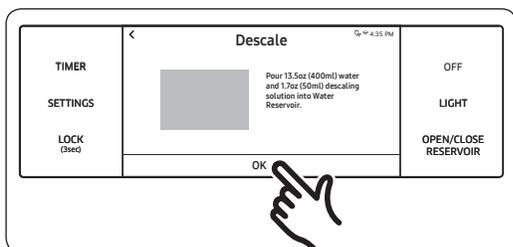

4. Follow the on-screen directions. (The process takes 3 hours.)

Empty, clean, and refill the water reservoir with 1.7 oz (50 ml) of descaling agent and 13.5 oz (400 ml) of drinkable water.

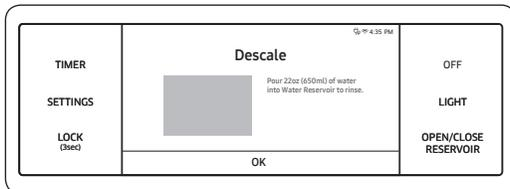
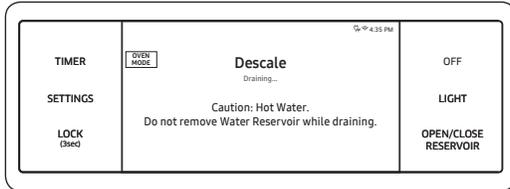

5. When descaling is complete, the oven drains water automatically.
6. Use oven mitts to remove and empty the water reservoir, then refill it with 22 oz (650 ml) of drinkable water.
7. Follow the on-screen directions, and tap OK to start rinsing.
8. When rinsing is complete, use oven mitts to empty/clean the reservoir.

### **⚠ WARNING**

Use only descaling agents designed for steam ovens or coffee machines.

### **⚠ CAUTION**

- Running Descaling disables Steam Bake and Steam Roast. If you cancel a descaling cycle, you must restart and complete it within 3 hours to re-enable Steam Bake and Steam Roast.
- Keep children away from the oven during the descaling cycle.
- If the descaling agent's ratio of water to descaling agent differs from Dacor's ratio (8:1), use the descaling agent's ratio.

### **📄 NOTE**

Though the oven automatically starts descaling in 5 seconds without your confirmation, you should confirm your selection to keep descaling from starting by mistake.

# Operations

## Draining

When a steam function is complete, drain the remaining water so it does not affect other cooking modes.

### How to run a draining

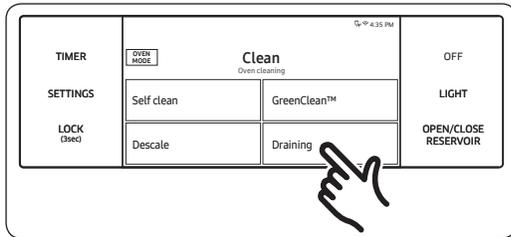

1. Swipe the screen to **Clean**. The display will show 4 cleaning selections.
2. Tap **Draining**.

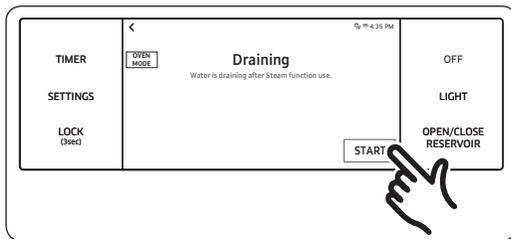

3. Tap **START**. The oven drains water from the steam generator to the water reservoir.

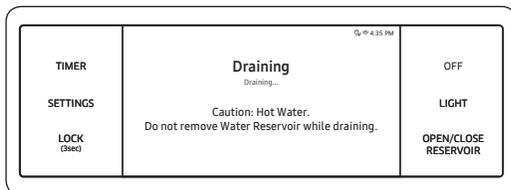

4. When draining is complete, use oven mitts to remove and empty the water reservoir.

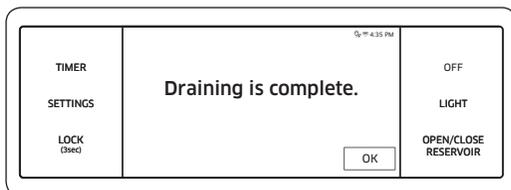

### NOTE

Once the oven starts draining, wait until the draining cycle is complete.

## Settings

In Settings, you can change the default settings to your preference or diagnose problems with the network connection.



Tap **SETTINGS**. The display will show the Setting item.

## Wi-Fi

To enable a Wi-Fi connection

1. Tap **SETTINGS** > **Connections** > **Wi-Fi**, then tap **ON** in the right screen.
2. Tap **Wi-Fi**, and then tap a Wi-Fi network in the list that appears.
3. You will be prompted to provide a password for a secure network. Enter the password.

To manually input an IP

1. Tap **SETTINGS** > **Connections** > **Wi-Fi**, then tap **ON** in the right screen.
2. Tap **Wi-Fi**, and then tap **Add Network**.
3. Enter an IP, then tap **CONNECT** to apply your settings.

### **NOTE**

- To disable a Wi-Fi connection, tap **SETTINGS** > **Connections** > **Wi-Fi**, then tap **OFF** in the right screen.
- For details about the Wi-Fi connection and using the Dacor iQ Kitchen app, see the Dacor iQ Kitchen instruction manual.

# Operations

---

## Display

### 1. Brightness

You can change the brightness of the display screen.

- Tap **SETTINGS** > **Display** > **Brightness**, and then use the bar next to Brightness to adjust the brightness of the screen.

### 2. Screen saver

If screen saver is turned off, the Clock theme and Timeout menu are disabled.

- Tap **SETTINGS** > **Display** > **Screen saver**, and then tap **OFF** in the right screen.

### 3. Clock theme

- Tap **SETTINGS** > **Display** > **Clock theme**, and then tap in the right screen. You can select a theme.

### 4. Timeout

- Tap **SETTINGS** > **Display** > **Timeout**, and then tap in the right screen. You can select a time from 5 minutes to 60 minutes.

## Date & Time

To enable automatic date and time

1. Turn on the Wi-Fi connection.
2. Tap **SETTINGS** > **Date & Time**, and then tap **Date & Time** > **Automatic date and time**, and then tap **ON** in the right screen. The date and time are set automatically.

To manually input date and time

1. Tap **SETTINGS** > **Date & Time**, and then tap **Date & Time** > **Automatically date and time**, and then tap **OFF** in the right screen. Time zone, set date, and set time are activated.
2. You can set the time zone, date, and time.

To change the time format

1. Tap **SETTINGS** > **Date & Time** > **Select time format**, and then tap in the right screen.
2. You can select 12-hour clock or 24-hour clock.

## Language

Choose a display language.

1. Tap **SETTINGS** > **Language**, and then tap in the right screen.
2. You can select English, Spanish, or French.

---

## Volume

Adjust the volume level for beeps and melodies.

- Tap **SETTINGS** > **Volume**, and then use the bar next to Volume to adjust the volume.

## Temp

### 1. Temp unit

You can program the oven control to display the temperature in Fahrenheit or Celsius. The oven has been preset at the factory to display in Fahrenheit.

- Tap **SETTINGS** > **Temp** > **Temperature Unit**, and then tap in the right screen. You can select °C or °F.

### 2. Temp adjust

Oven temperature is factory-calibrated. When first using the oven, be sure to follow recipe times and temperatures.

If you think the oven is too hot or too cool, you can adjust the temperature setting. First, test a recipe by using a temperature above or below what is recommended. The results should help you make the adjustment. Oven temperature can be adjusted  $\pm 35$  °F ( $\pm 19$  °C).

- Tap **SETTINGS** > **Temp** > **Temperature Adjust**, and then tap in the right screen. You can increase or decrease the temperature by 35 °F (19 °C).

### NOTE

This adjustment will not affect the broiling or the self-cleaning temperatures. The adjustment will be retained in memory after a power failure.

## 12 hour energy Saving

If you accidentally leave the oven on, this feature will automatically turn off the oven after 12 hours during baking functions or after 3 hours during a broil function.

1. Tap **SETTINGS** > **12 hour energy Saving**, and then tap **ON** in the right screen.
2. The 12 hour energy saving icon will appear in the indicator area.

## iQ control

To start the oven remotely.

- Tap **SETTINGS** > **Connections** > **iQ Control**, and then tap **ON**. (See the using the iQ control feature section on page 50.)

# Operations

---

## Easy connection

Easy connection enables you to easily configure the network settings including the authentication procedure.

- Tap **SETTINGS** > **Connections** > **Easy connection**, and then tap **CONNECT**.

## Help

Help provides useful tips and explanations on a specific item that you select.

### 1. Troubleshooting

- Tap a checkpoint directly on the screen, and try the suggestions.

### 2. Guide for first use

- Provides simple instructions on the basic use of the oven.

## About device

You can see information about the oven and do a software update.

To update the software:

1. Tap **SETTINGS** > **About device** > **Software update**, and then tap **Update** in the right screen.
2. Tap **INSTALL**. The software is updated and the system restarts automatically.

## Sabbath

You can set Sabbath mode. See the **Using the sabbath feature** section on the next page.

## Demo mode

This option is for use by retail establishments for display purposes only. (The heating element does not operate.)

1. Tap **SETTINGS** > **Demo mode**, and then tap **ON** in the right screen.
2. The Demo mode indicator appears on screen.

## Remote Management

The call center will access your product remotely to check internal when you have some problems.

- Tap **SETTINGS** > **Connections** > **Remote management**, and then tap **ACTIVATE**.

## Using the sabbath feature

(For use on the Jewish Sabbath & Holidays)

 For further assistance, guidelines for proper usage, and a complete list of models with the Sabbath feature, visit <http://www.star-k.org>.

You can use **Sabbath** with baking only. The oven temperature may be set higher or lower after you set **Sabbath**. (The oven temperature adjustment feature should be used only during Jewish holidays.) The display will not change, and no tones sound if a change is made. Once the oven is set for baking with **Sabbath** active, the oven stays on until **Sabbath** is cancelled. This overrides the factory preset 12-hr energy-saving feature. If the oven light is needed while **Sabbath** is active, touch LIGHT before activating **Sabbath**. Once the oven light is on and **Sabbath** is active, the oven interior light stays on until **Sabbath** is turned off. If the oven light needs to be off, turn the oven light off before activating **Sabbath**.

### How to use the Sabbath feature



1. Swipe the screen to Bake mode.



2. Set the temperature and cook time you want.
3. Tap START.

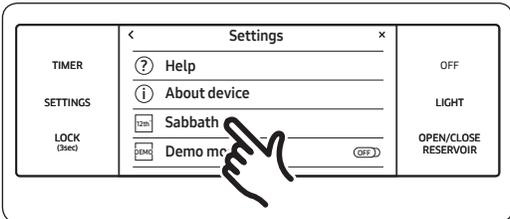

4. Tap **SETTINGS** > **Sabbath**, to activate. You may change the oven temperature once baking starts. The oven will not beep or show further changes while **Sabbath** is active.

# Operations

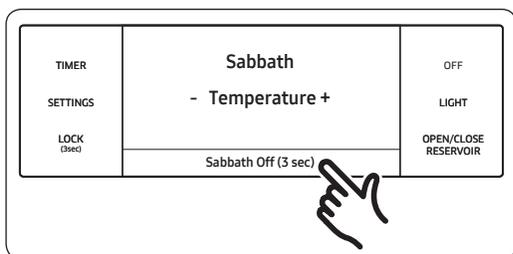

5. You can turn the oven off at any time by touching OFF. Note that this does not turn Sabbath mode off.
6. To turn Sabbath mode off, touch and hold Sabbath Off for 3 seconds.

- ★ Do not try to activate programs other than **Bake** while **Sabbath** is active.
- 📄 You can change the oven temperature, but the display will not change nor tones sound when a change occurs. (The oven temperature adjustment feature should be used only on Jewish holidays.) When you change the temperature in Sabbath mode, the oven takes 15 seconds to recognize the change.
- 📄 You can set **Cook Time** before activating **Sabbath**.
- 📄 If there is a power failure/interruption, the oven shuts itself off. When power returns, the oven does not turn itself on. **Sabbath** appears on the control screen, but the oven will not operate. Food may be safely removed from the oven during Sabbath mode, but the oven cannot be turned on until after the Sabbath Holidays. Touch-hold Sabbath Off for 3 seconds to turn off Sabbath mode.
- ★ Do not open the oven door or change the temperature for 30 minutes after entering Sabbath mode to let the oven reach the set temperature. For best performance, the oven fan operates only when the oven temperature is rising.

# Care and maintenance

---

## Care and cleaning of the oven

---

### Cleaning painted parts and decorative trim

- For general cleaning, use a cloth with hot, soapy water.
- For more difficult residue and greasy buildup, apply a liquid detergent directly to the area. 30 – 60 minutes later, wipe with a damp cloth, then wipe with a wet cloth, and dry. Do not use abrasive cleaners anywhere on the oven.

### Cleaning stainless-steel surfaces

1. Shake a bottle of stainless-steel appliance cleaner/polish well.
2. Place a small amount of cleaner/polish on a damp cloth/paper towel.
3. Clean a small area, rubbing with the grain of the metal (if applicable).
4. Dry and buff with a clean, dry paper towel, or soft cloth.
5. Repeat as needed.

#### NOTE

- Do not use a steel-wool pad.
- If a mineral-oil-based stainless-steel appliance cleaner has been used to clean the oven, wash the surface with dish soap and water before using the stainless-steel appliance cleaner/polish.

### Convection filter

This is in the back wall of each oven chamber. Clean the filter regularly. If you let it become clogged, the oven's convection cooking modes will not work properly.

Remove the filter during a self-clean cycle.

#### NOTE

For your safety and proper oven performance, re-install the filter before using the oven to cook so the spinning fan blades at the back of the oven are not exposed.

# Care and maintenance

---

## Removing your oven's convection filter

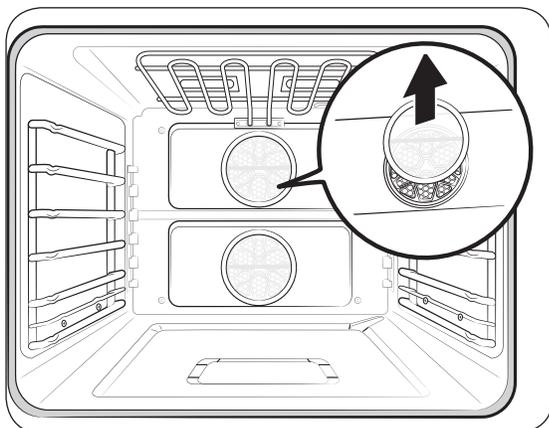

When the oven is cool, grasp the edges of the filter with your fingertips, and gently push up.

## To clean the filter

Soak the filter in hot, soapy water, then rinse it well. You may also put it on the top rack of a dishwasher. Dry the filter before re-installing it.

## Installing your oven's convection filter

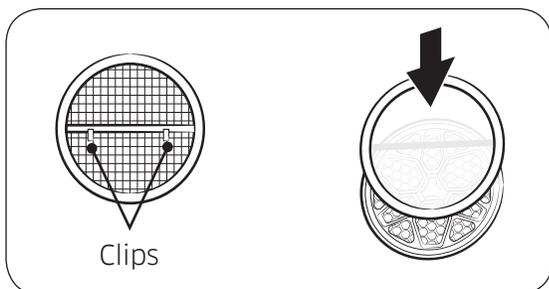

Carefully hook the metal clips on the back of the filter over the metal bar across the fan hole. Center the filter over the hole. Take care not to scratch the porcelain with the back of the filter.

---

### Oven racks

- If the racks are left in the oven during a self-cleaning cycle, they will discolor and turn dull. After self-cleaning when the oven is cool, rub the sides of the racks with wax paper or a cloth dabbed with a small amount of oil. The racks will glide more smoothly.
- Gliding racks may be cleaned by hand with an abrasive cleaner or steel wool. During cleaning, do not let water or cleaner get in the slides on the sides of rack.

#### NOTE

- Do not clean the racks in a dishwasher.
- If a rack becomes hard to remove/replace, lightly wipe the guides with cooking oil. Do not wipe cooking oil on the slides.
- If oil does not help sufficiently, a graphite lubricant may be applied to the rack. (To order graphite lubricant., call Dacor Customer Service: (800) 793-0093 or visit: <http://www.dacor.com/Customer-Care/Service-Parts>) and search for part no. DG81-01629A.

# Care and maintenance

---

## To lubricate the slides of the gliding rack

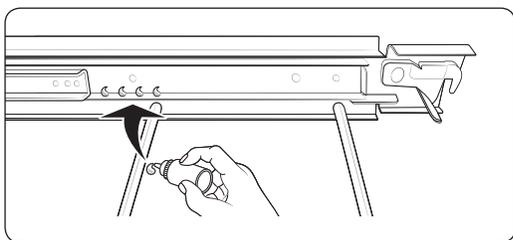
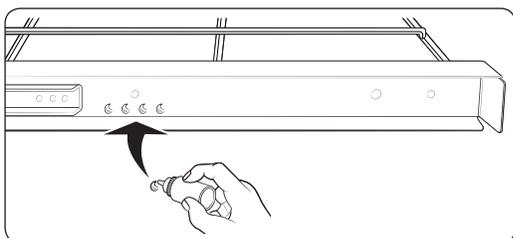
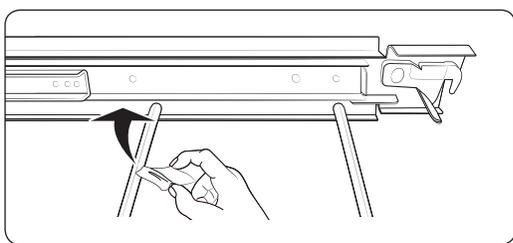
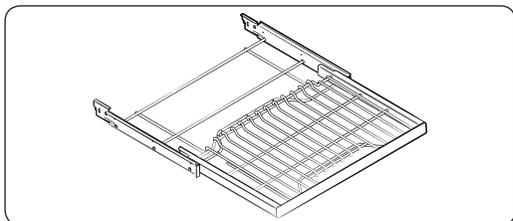

1. Remove the rack from the oven. (See pg. 32.)
2. Fully extend the rack on a large, flat surface. (Lay newspaper under the rack for easy cleanup.)
3. Wipe debris from the slide tracks with a paper towel.
4. Shake the lubricant bottle before opening it. Starting with the left (front and back) slide mechanism, place 4 small drops of lubricant on the 2 bottom slide tracks close to the bearing carriers.

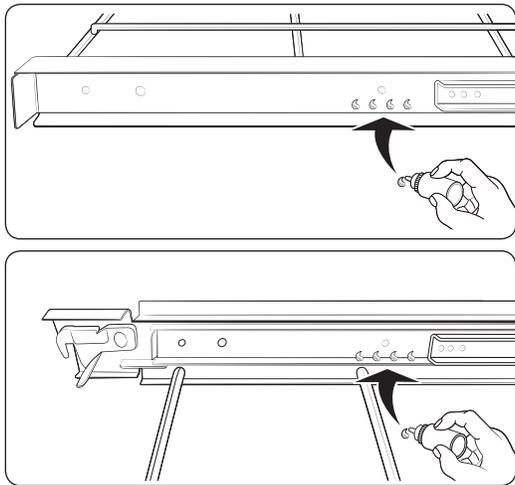

5. Repeat for the right (front and back) slide mechanism.
6. Open-close the rack several times to distribute the lubricant.
7. Replace the cap on the lubricant and shake it again. Turn the rack over and repeat Steps 3 – 6.
8. Close the rack, turn it right-side up, and install it in the oven. (See pg. 32.)

 **NOTE**

Do not spray the gliding rack with cooking spray or other lubricants.

# Care and maintenance

---

## Rack support

Rack supports can be removed for cleaning. (Self clean, GreenClean™ and Manual clean).

### Removing the rack supports

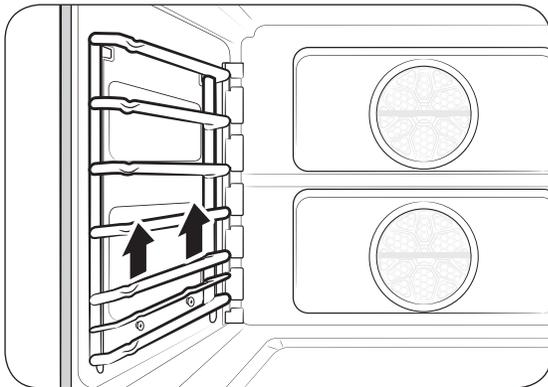

1. Grasping from the middle, lift the rack support upward.

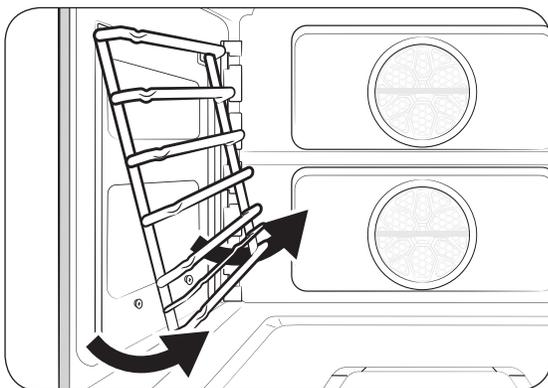

2. Rotate the rack support about 45°.

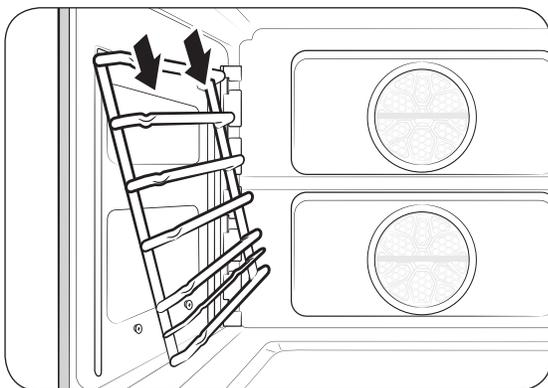

3. Pull the rack support from its two holes.

---

## Replacing the rack supports

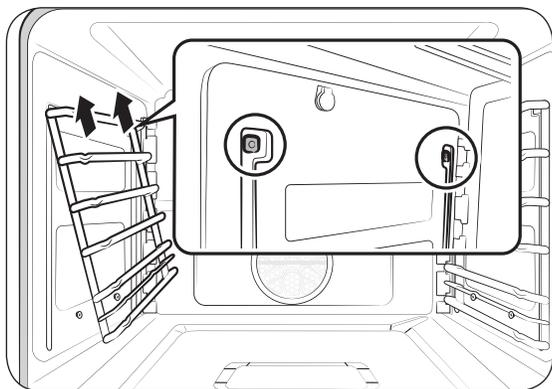

1. Put the rack support into the two holes.

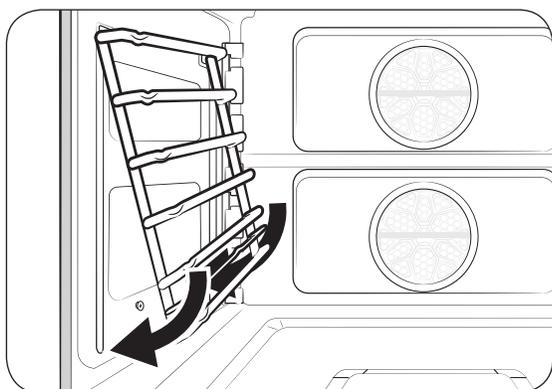

2. Rotate the bottom of the rack support to the oven wall.

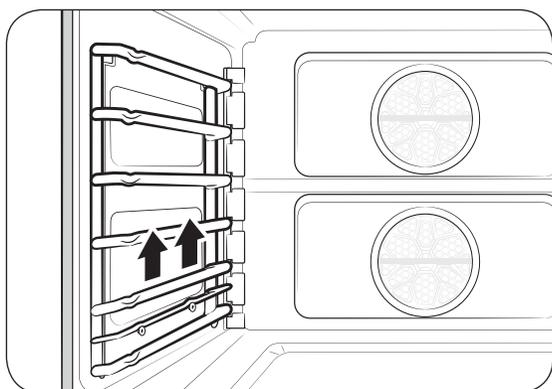

3. Grasping at the middle, push the rack support downward, then press the support into the holes in the oven wall.

# Care and maintenance

---

## Oven door

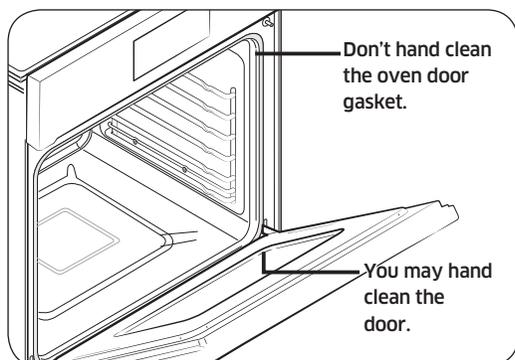

- With soap and water, thoroughly clean the top, sides, and front of the oven door. Rinse well. You may use a glass cleaner on the exterior glass. For stains on the inside of the door, use a cloth with vinegar or soap. Wipe with a damp cloth and dry. **DO NOT** immerse the door in water. **DO NOT** spray or let water or glass cleaner into the door vents. **DO NOT** use oven cleaners, powders, or harsh abrasive material on the outside of the door.
- **DO NOT** clean the oven door gasket, which is made of a woven material that is essential for a good seal. Do not rub, damage, or remove the gasket.

---

## Removing the oven doors

---

### ⚠ CAUTION

- The door is very heavy. Be careful when removing and lifting the door.
- Do not lift the door by the handle.

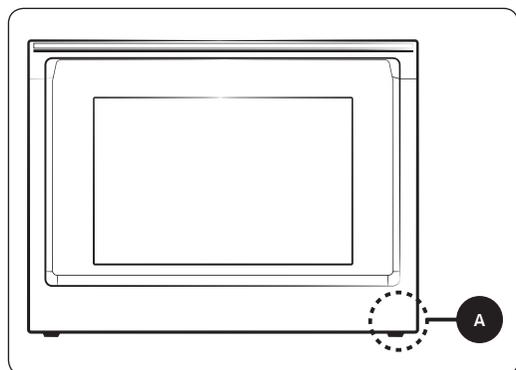

A. Wire Harness

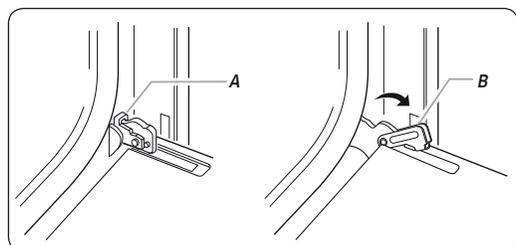

A. Oven door hinge lock in locked position

B. Oven door hinge lock in unlocked position

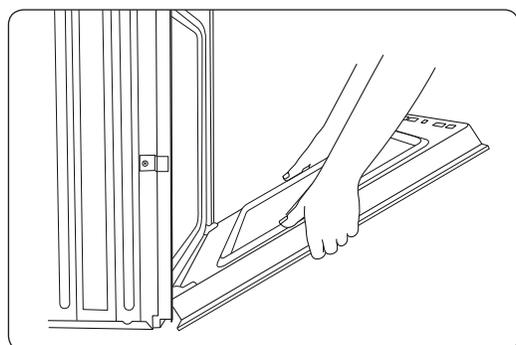

1. Lay out a soft blanket on a large, flat, sturdy surface, or use the corner posts from your packing material.
2. Disconnect the LED's wire harness (bottom right corner of the door).
3. Open the oven door.
4. Find the hinge locks in both corners of the door, and flip the locks outward to the unlocked position. If the hinge lock is not rotated fully (graphic B, at left), the door will not come off properly.
5. Partially close the door to engage the door latch locks. The door stops at this point.

# Care and maintenance

---

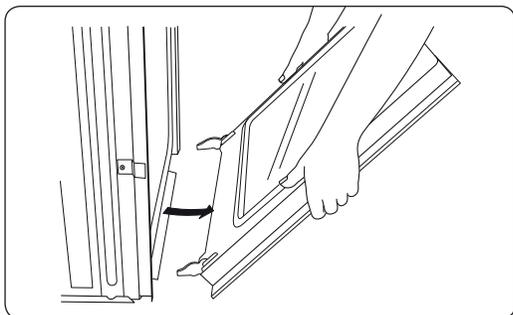

6. Grasp both sides of the oven door below the handle. Lift and pull the door away from the oven. Gently rock the door side to side if needed.
7. Set the oven door, handle down, on the prepared surface.

## Re-installing the oven doors

---

### CAUTION

The door is very heavy. You may need help lifting the door high enough to slide it into the hinge slots. Do not lift the door by the handle.

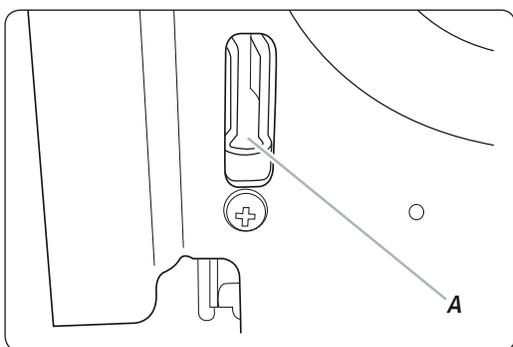

**A.** Slot in the oven chamber for the door hinge lock

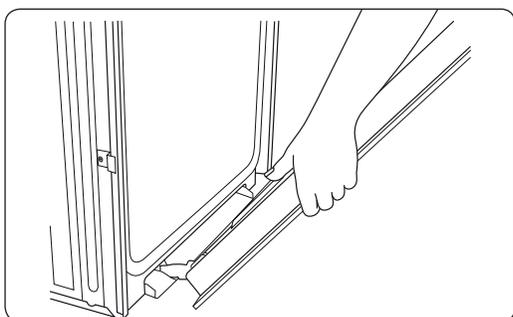

1. Grasp both sides of the door below the handle.
2. Position the door hinge locks before the slots at the bottom-front of the oven face.
3. Maintaining a 45° angle, slowly insert the hinge locks into the slots. You will know the door is engaged when you feel a slight drop.

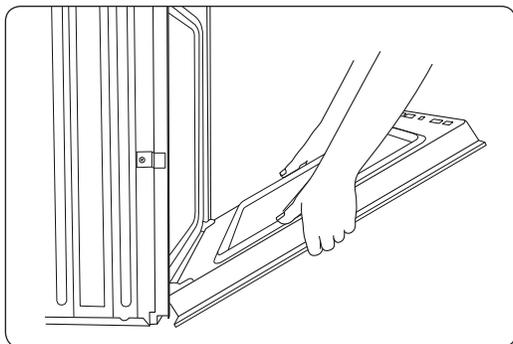

4. Open the door fully. If it does not lie perpendicular to the oven, remove the door, and repeat Steps 1 – 3.
5. At each hinge of the oven door, flip the hinge locks up into the locked position. (See **Removing the oven doors**, Step 3, graphic A, pg. 75.)
6. Close the oven door.  
There should be an even gap between the door and control panel. If one side has a wider gap, the hinge on that side is improperly installed.
7. Reconnect the LED wire harness.

**⚠ CAUTION**

Push the wiring inward as it was before you removed the door. Dangling wiring may snag on the door or become heat-damaged.

# Care and maintenance

---

## Changing the oven light

---

The oven light is a standard, 40-watt appliance halogen bulb. It comes on automatically when the oven door is opened. If the door is closed, touch **LIGHT** on the control screen to turn the light on/off. You cannot turn the light on during a self-cleaning cycle.

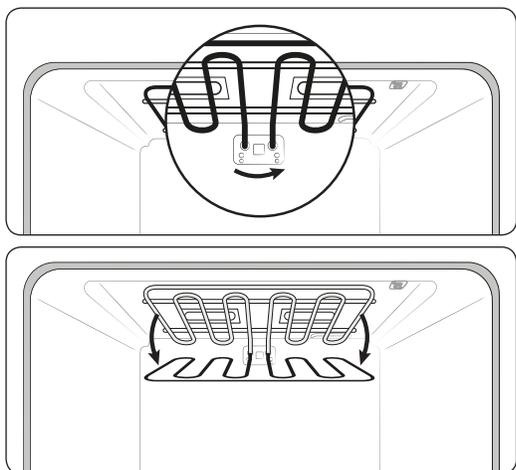

1. Remove power to the oven at the main fuse or circuit breaker, and ensure the oven and bulb are cool.
2. While supporting the element, turn the circular nut on the rear wall counter-clockwise. The element loosens and tilts down.

**Important:** The broil element is not removable. Do not force the element down or let it drop.

3. Remove the glass cover and bulb cover.
4. Replace the bulb.
5. Re-install the covers, then hold the broil element in its operating position, and turn the nut clockwise to tighten.

# Troubleshooting

If there is an issue with the oven, review these tables for a possible resolution. If you are unable to resolve the issue, call Dacor Customer Service: (800) 793-0093.

## Control display

Problem	Possible cause	Solution
Display goes blank	Blown fuse or tripped circuit breaker	Replace fuse or reset circuit breaker
Control screen not responding	<ul style="list-style-type: none"> <li>Moisture/residue on screen</li> <li>The lock function is set</li> <li>User is wearing oven mitt or has residue on finger</li> </ul>	<ul style="list-style-type: none"> <li>Remove the moisture/residue, and try again</li> <li>Cancel lock function</li> <li>Remove mitt; wipe off finger</li> </ul>

## Oven

Problem	Possible cause	Solution
Oven will not turn on	Power plug not properly inserted in outlet	Properly insert plug; ensure outlet is properly wired
	Blown fuse/tripped circuit breaker	Replace fuse or reset circuit breaker
	Oven controls improperly set	See <b>Operations</b> , pg. 19
	Oven too hot	Let oven cool
	Incomplete service wiring	Call for service
	Power outage	Check house lights; if needed, call utility supplier for service.
Oven light will not turn on	Light is loose/defective/burnt out	Tighten/replace lamp; call for service if new light will not come on.
	Operating switch is broken	Call for service.

# Troubleshooting

Problem	Possible cause	Solution
Oven smokes excessively during broiling	Oven controls improperly set	See <b>Operations</b> , pg. 19
	Meat is too close to broil element	Reposition rack for proper clearance between meat and element; preheat broil element for searing
	Meat improperly prepared.	Trim excess fat from meat
	Grease buildup on oven surfaces	Clean oven chamber regularly
Food does not bake/roast properly	Oven controls improperly set	See <b>Operations</b> , pg. 19
	Oven rack improperly positioned or not level	See <b>Using the oven racks</b> , pg. 29
	Oven thermistor needs adjusting	See <b>Temp adjust</b> , pg. 63.
Food does not broil properly	Serving size too large/small	See <b>Broiling recommendation guide</b> , pg. 40, and try again.
	Rack improperly positioned	See <b>Broiling recommendation guide</b> , pg. 40
	Cookware not suited for broiling	Use suitable cookware.
	(Some geographic areas) Insufficient voltage	Preheat broil element for 10 min. See <b>Broiling recommendation guide</b> , pg. 40
Oven temp too hot/cold	Oven thermistor needs adjusting	See <b>Temp adjust</b> , pg. 63.

Problem	Possible cause	Solution
Dripping water	These issues depend on type of food being cooked; this is not a product malfunction	Let oven cool, then dry with dish towel
Steam seeps from door seam		
Water left in oven		
Boiling sounds during steam cooking	Water is being heated by steam heater	Normal operation
Oven will not self-clean	Oven temp too high to start self-clean cycle	Let oven cool, then reset controls
	Oven controls set incorrectly	See <b>Self clean</b> , pg. 52-53
	Self-clean cycle cannot start if oven lockout is active	Cancel oven lockout (see pg. 23)
Excessive smoke during self-clean cycle	Excessive food residue in oven	Press OFF. Open windows to vent smoke; wait for self-clean cycle to be cancelled; wipe up excess soil; restart self-clean cycle
Oven door stays locked after self-clean cycle	Oven too hot	Let oven cool
Oven not clean after self-clean cycle	Oven controls set incorrectly	See <b>Self clean</b> , pg. 52-53
	Excessive food residue in oven	Wipe up spillovers before starting self-clean cycle; very dirty ovens may need additional self-cleaning or longer cycles.

# Troubleshooting

---

Problem	Possible cause	Solution
Steam from vent	During convection baking, steam normally comes from oven vent	Normal operation
	High volume of food being cooked	
Burning/oily odor from vent	Normal for new oven; odor vanishes after a few uses	To burn off odor quicker, run self-clean cycle for at least 3 hrs (see <b>Self clean</b> , pg. 52-53)
Strong odor	Odor from insulation around oven chamber is normal initially; odor vanishes after a few uses	Operate oven empty on <b>Bake</b> at 400 °F for 1 hour
Fan noise	Convection fan normally cycles on and off	Normal operation
Oven racks do not slide easily	Chrome racks went through self-clean cycle	Apply dab of veg. oil to paper towel; wipe edges of racks
Oven door will not open	Tripped circuit breaker or power failure while door was locked	Activate Control Lockout, then unlock the control (see <b>Control Lockout</b> , pg. 23)

## Information codes

### Oven

Displayed Code	Possible cause	Solution
C-d0	Control key was short for 1 minute	Clean buttons, and wipe away any moisture; turn off oven, and retry; if issue persists, contact Dacor Customer Service
C-d1	Door lock mispositioned	Press OFF, and restart oven; if issue persists, disconnect all power to oven for at least 30 seconds, and reconnect power; if issue persists, call for service.
C-F0	Communication between Main and Sub PBA was interrupted	
C-F2	Communication between Main and Touch was interrupted	
C-20	Oven sensor is open when oven operates	
	Oven sensor is short when oven operates	
C-21	Abnormally high internal temp	
C-23	Temp probe sensor is short when oven operates	
C-30	PCB sensor is open when oven operates	
	PCB sensor is short when oven operates	
C-31	Abnormally high PCB temp	Call for service

# Troubleshooting

---

Displayed Code	Possible cause	Solution
C-70	Steam sensor is open when oven operates	Press OFF, and restart oven; if issue persists, disconnect all power to oven for at least 30 seconds, and reconnect power; if issue persists, call for service.
	Steam sensor is short when oven operates	
C-72	Drain system problems	
C-A2	Abnormal cooling motor function	Call for service

# Warranty and Service

---

## Getting Help

---

Before you request service:

you request service:

1. Review the **Troubleshooting** section of this manual (see page 79).
2. Use the helpful tips found in our **Troubleshooting**.
3. Become familiar with the warranty terms and conditions of your product.
4. If none of these tips or suggestions resolves your problem, call our Customer Service center at the number below.

Dacor's Customer Service center is available 6:00 A.M. to 5:00 P.M. Pacific Time

For warranty repairs or questions and for Dacor Distinctive Service (DDS) in the US and Canada

Phone: (800) 793-0093, extension 2822

For non-warranty repairs or questions in the US and Canada

Phone: (800) 793-0093, extension 2813

Contact us through our website at:

[www.dacor.com/contact-us](http://www.dacor.com/contact-us)

## Warranty

---

### What Is Covered

**CERTIFICATE OF WARRANTIES: DACOR OVENS**

**WITHIN THE FIFTY STATES OF THE U.S.A., THE DISTRICT OF COLUMBIA, AND CANADA:**

### FULL ONE-YEAR WARRANTY

The warranty applies only to the Dacor appliance sold to the first use purchaser, starting from the date of original retail purchase or closing date for new construction, whichever period is longer. Warranty is valid on products purchased brand new from a Dacor Authorized Dealer, or other seller authorized by Dacor.

If your Dacor product fails to function within one year of the original date of purchase, due to a defect in material or workmanship, Dacor will remedy it without charge to you.

# Warranty and Service

---

All cosmetic damage (such as scratches on stainless steel, paint/porcelain blemishes, etc.) to the product or included accessories must be reported to Dacor within 60 days of the original purchase date to qualify for warranty coverage. Consumable parts such as filters and light bulbs are not covered and are the responsibility of the purchaser.

## LIMITATIONS OF COVERAGE

Service will be provided by a Dacor designated service company during regular business hours. Please note service providers are independent entities and are not agents of Dacor. Dealer display and model home display products with a production date greater than 5 years, products sold “As Is,” and products installed for non-residential use, which include but are not limited to religious organizations, fire stations, bed and breakfast, and spas carry a one year parts warranty only. All delivery, installation, labor costs, and other service fees are the responsibility of the purchaser.

Warranty will be null and void on product that has altered, defaced, or missing serial numbers and tags.

The owner must provide proof of purchase or closing statement for new construction upon request. All Dacor products must be accessible for service.

Warranty is null and void if non-ETL or non-CUL approved product is transported from the U.S.A.

## OUTSIDE THE FIFTY STATES OF THE U.S.A, THE DISTRICT OF COLUMBIA, AND CANADA:

### LIMITED FIRST YEAR WARRANTY

If your Dacor product fails to function within one year of the original date of purchase due to a defect in material or workmanship, Dacor will furnish a new part, F.O.B. factory to replace the defective part.

All delivery, installation, labor costs and other service fees are the responsibility of the purchaser.

### What Is Not Covered

- Slight color variations may be noticed because of differences in painted parts, kitchen lighting, product placement, and other factors; this warranty does not apply to color variation.
- Service calls to educate the customer on proper use and care of the product.
- Service fees for travel to islands and remote areas, which include but are not limited to, ferries, toll roads or other travel expenses.
- Consequential or incidental damage, including but not limited to food or medicine loss, time away from work or restaurant meals.

- 
- Failure of the product when used for commercial, business, rental or any application other than for residential consumer use.
  - Failure of the product caused by improper product installation.
  - Replacement of house fuses, fuse boxes or resetting of circuit breakers.
  - Damage to the product caused by accident, fire, flood, power interruption, power surges or other acts of God.
  - Liability or responsibility for damage to surrounding property including cabinetry, floors, ceilings and other structures or objects around the product.
  - Breakage, discoloration, or damage to glass, metal surfaces, plastic components, trim, paint or other cosmetic finish caused by improper usage, care, abuse or neglect.

### **Out of Warranty**

Should you experience a service issue beyond the standard warranty period, please contact us. Dacor reviews each issue and customer concern to provide the best possible solution based on the circumstances.

THE REMEDIES PROVIDED IN THE ABOVE EXPRESS WARRANTIES ARE THE SOLE AND EXCLUSIVE REMEDIES. THEREFORE, NO OTHER EXPRESS WARRANTIES ARE MADE, AND OUTSIDE THE FIFTY STATES OF THE UNITED STATES, THE DISTRICT OF COLUMBIA AND CANADA, ALL IMPLIED WARRANTIES, INCLUDING BUT NOT LIMITED TO, ANY IMPLIED WARRANTY OF MERCHANTABILITY OR FITNESS FOR A PARTICULAR USE OR PURPOSE, ARE LIMITED IN DURATION TO ONE YEAR FROM THE DATE OF ORIGINAL PURCHASE. IN NO EVENT SHALL DACOR BE LIABLE FOR INCIDENTAL EXPENSE OR CONSEQUENTIAL DAMAGES. IN THE EVENT DACOR PREVAILS IN ANY LAWSUIT, DACOR SHALL BE ENTITLED TO REIMBURSEMENT OF ALL COSTS AND EXPENSES, INCLUDING ATTORNEY'S FEES, FROM THE DACOR CUSTOMER. NO WARRANTIES, EXPRESS OR IMPLIED, ARE MADE TO ANY BUYER FOR RESALE.

Some states do not allow limitations on how long an implied warranty lasts, or do not allow the exclusion or limitation of inconsequential damages, therefore the above limitations or exclusions may not apply to you. This warranty gives you specific legal rights, and you may also have other rights that vary from state to state.

# Regulatory Notice

---

## 1. FCC Notice

### **CAUTION**

**FCC CAUTION:** Any changes or modifications not expressly approved by the party responsible for compliance could void the user's authority to operate the equipment.

This device complies with Part 15 of FCC Rules. Operation is Subject to following two conditions:

- 1)** This device may not cause harmful interference, and
- 2)** This device must accept any interference received including interference that cause undesired operation.

For products sold in the US and Canadian markets, only channels 1~11 are available. You cannot select any other channels.

### **FCC STATEMENT:**

This equipment has been tested and found to comply within the limits for a Class B digital device, pursuant to part 15 of the FCC Rules. These limits are designed to provide reasonable protection against harmful interference in a residential installation.

This equipment generates, uses, and can radiate radio frequency energy and, if not installed and used in accordance with the instructions, may cause harmful interference to radio communications. However, there is no guarantee that interference will not occur in a particular installation. If this equipment does cause harmful interference to radio or television reception, which can be determined by turning the equipment off and on, the user is encouraged to try to correct the interference by one or more of the following measures:

- Reorienting or relocating the receiving antenna
- Increasing the separation between the equipment and receiver

- 
- Connecting the equipment to an outlet that is on a different circuit than the radio or TV
  - Consulting the dealer or an experienced radio/TV technician for help.

### **FCC RADIATION EXPOSURE STATEMENT:**

This equipment complies with FCC radiation exposure limits set forth for an uncontrolled environment. This equipment should be installed and operated so there is at least 8 inches (20 cm) between the radiator and your body. This device and its antenna(s) must not be co-located or operated in conjunction with any other antenna or transmitter.

### **2. IC Notice**

The term “IC” before the radio certification number only signifies that Industry Canada technical specifications were met. Operation is subject to the following two conditions: (1) this device may not cause interference, and (2) this device must accept any interference, including interference that may cause undesired operation of the device.

This Class B digital apparatus complies with Canadian ICES-003. For products sold in the US and Canadian markets, only channels 1~11 are available. You cannot select any other channels.

### **IC RADIATION EXPOSURE STATEMENT:**

This equipment complies with IC RSS-102 radiation exposure limits set forth for an uncontrolled environment. This equipment should be installed and operated so there is at least 8 inches (20 cm) between the radiator and your body. This device and its antenna(s) must not be co-located or operated in conjunction with any other antenna or transmitter.

# Open Source Announcement

---

The software included in this product contains open source software. You may obtain the complete corresponding source code for a period of three years after the last shipment of this product by sending an email to <mailto:oss.request@samsung.com>.

It is also possible to obtain the complete corresponding source code in a physical medium such as a CD-ROM; a minimal charge will be required.

The following URL [http://opensource.samsung.com/opensource/OVEN\\_HKM\\_TZ/seq/0](http://opensource.samsung.com/opensource/OVEN_HKM_TZ/seq/0) leads to the download page of the source code made available and open source license information as related to this product. This offer is valid to anyone in receipt of this information.





Please visit [www.Dacor.com](http://www.Dacor.com) to activate your warranty online.

## WARRANTY INFORMATION



### IMPORTANT:

Your warranty will not begin until you activate it online or return this form to Dacor. If you have purchased more than one Dacor product, please return all forms in one envelope, or activate the warranty for each product online.

Please rest assured that under no conditions will Dacor sell your name or any of the information on this form for mailing list purposes. We are very grateful that you have chosen Dacor products for your home and we do not consider the sale of such information to be a proper way of expressing our gratitude!

**Owner's Name:** \_\_\_\_\_  
Last (Please Print or Type) First Middle

Street: \_\_\_\_\_

City: \_\_\_\_\_ State: \_\_\_\_\_ Zip: \_\_\_\_\_

**Purchase Date:** \_\_\_\_\_ **Email:** \_\_\_\_\_ **Telephone:** \_\_\_\_\_

Dealer: \_\_\_\_\_

City: \_\_\_\_\_ State: \_\_\_\_\_ Zip: \_\_\_\_\_

Your willingness to take a few seconds to fill in the section below will be sincerely appreciated. Thank you.

1. How were you first exposed to Dacor products? (Please check one only.)

- |   |   |
|---|---|
| <input type="checkbox"/> A. T.V. Cooking Show         | <input type="checkbox"/> F. Builder             |
| <input type="checkbox"/> B. Magazine                  | <input type="checkbox"/> G. Architect/Designer  |
| <input type="checkbox"/> C. Appliance Dealer Showroom | <input type="checkbox"/> H. Another Dacor Owner |
| <input type="checkbox"/> D. Kitchen Dealer Showroom   | <input type="checkbox"/> I. Model Home          |
| <input type="checkbox"/> E. Home Show                 | <input type="checkbox"/> J. Other _____         |

2. Where did you buy your Dacor appliances?

- |  |   |
|--|---|
| <input type="checkbox"/> A. Appliance Dealer | <input type="checkbox"/> D. Builder     |
| <input type="checkbox"/> B. Kitchen Dealer   | <input type="checkbox"/> E. Other _____ |
| <input type="checkbox"/> C. Builder Supplier |   |

3. For what purpose was the product purchased?

- |   |   |
|---|---|
| <input type="checkbox"/> A. Replacement <b>only</b> | <input type="checkbox"/> C. New Home    |
| <input type="checkbox"/> B. Part of a Remodel       | <input type="checkbox"/> E. Other _____ |

4. What is your household income?

- |   |   |
|---|---|
| <input type="checkbox"/> A. Under \$75,000        | <input type="checkbox"/> D. \$150,000 - \$200,000 |
| <input type="checkbox"/> B. \$75,000 - \$100,000  | <input type="checkbox"/> E. \$200,000 - \$250,000 |
| <input type="checkbox"/> C. \$100,000 - \$150,000 | <input type="checkbox"/> F. Over \$250,000        |

5. What are the brands of appliances that you have in your kitchen?

- |                  |                       |
|------------------|-----------------------|
| A. Cooktop _____ | C. Dishwasher _____   |
| B. Oven _____    | D. Refrigerator _____ |

6. Would you buy or recommend another Dacor product?

- |                              |                             |
|------------------------------|-----------------------------|
| <input type="checkbox"/> Yes | <input type="checkbox"/> No |
|------------------------------|-----------------------------|

**Comments:** \_\_\_\_\_  
\_\_\_\_\_  
\_\_\_\_\_

Thank you very much for your assistance. The information you have provided will be extremely valuable in helping us plan for the future and giving you the support you deserve.



Website: [www.Dacor.com](http://www.Dacor.com)  
Phone: 1+800+793-0093

cut here

cut here



NO POSTAGE  
NECESSARY  
IF MAILED  
IN THE  
UNITED STATES

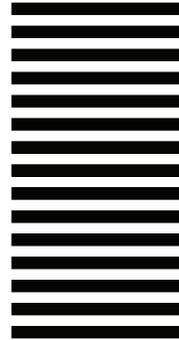

**BUSINESS REPLY MAIL**  
FIRST-CLASS MAIL PERMIT NO 1600 CITY OF INDUSTRY CA

POSTAGE WILL BE PAID BY ADDRESSEE

**DACOR**  
**ATTN: WARRANTY PROCESSING DEPT**  
**PO BOX 90070**  
**CITY OF INDUSTRY, CA 91715-9907**



fold here



DG68-00920A-00

