

# OWNER'S MANUAL

# DRYER

**Read this owner's manual thoroughly before operating the appliance  
and keep it handy for reference at all times.**

DLEX7600\*  
DLGX7601\*



MFL67731070

[www.lg.com](http://www.lg.com)

# TABLE OF CONTENTS

## 3 PRODUCT FEATURES

---

## 4 SAFETY INSTRUCTIONS

---

- 5 IMPORTANT SAFETY INSTRUCTIONS
- 7 GROUNDING INSTRUCTIONS
- 8 CALIFORNIA SAFE DRINKING WATER AND TOXIC ENFORCEMENT ACT

## 9 PRODUCT OVERVIEW

---

- 9 Parts
- 9 Accessories
- 9 Safety Tether Kit
- 9 Two-Way Reversible Door (on some models)

## 10 INSTALLATION

---

- 10 Installation Overview
- 10 Product Specifications
- 11 Installation Location Requirements
- 11 Clearances
- 13 Leveling the Dryer
- 13 Reversing the Door
- 21 Installing the Side Vent Kit
- 22 Venting the Dryer
- 25 Connecting Gas Dryers
- 27 Connecting Electric Dryers
- 31 Final Installation Check
- 32 Installation Test (Duct Check)

## 34 OPERATION

---

- 34 Using the Dryer
- 35 Check the Lint Filter Before Every Load
- 35 Sorting Loads
- 35 Loading the Dryer
- 36 Using the LG EasyLoad™
- 37 Control Panel
- 39 Cycle Guide
- 40 Cycle Settings and Options
- 43 Steam Functions (Steam Models)

## 44 SMART FEATURES

---

- 44 Tag On (on some models)

## 50 MAINTENANCE

---

- 50 Regular Cleaning

## 51 TROUBLESHOOTING

---

- 51 FAQs: Frequently Asked Questions
- 51 User Support Videos
- 52 Before Calling for Service

## 60 SMART DIAGNOSIS™

---

- 60 Using Smart Diagnosis™

## 61 WARRANTY (USA)

---

# PRODUCT FEATURES

## Easy-to-Use Control Panel

An entire selection of user-friendly functions make operating the dryer easy.

## Two-way Easy-access Reversing Door

The LG EasyLoad™ can be tilted open from the top, hamper-style, allowing you to easily load the dryer without items falling on the floor. The door still swings open to provide easy access for unloading or loading of bulkier items. The door hinge can be reversed to adjust to the installation location.

## Steam Functions (Steam Models)

LG's steam technology allows you to inject fabrics with a swirling jet of steam to refresh clothes, reduce static, and make ironing easier. Simply select the Steam Fresh™ cycle or Wrinkle Care cycle.

## Flow Sense™ Duct Blockage Sensing System Indicator

The Flow Sense™ duct blockage sensing system detects and alerts you to restrictions in the installed household ductwork that reduce exhaust airflow through the dryer. If you see the alert: Clean or repair the ducts to remove the restrictions. Keep your ducts free of blockage to help increase efficiency and reduce long drying times caused by blocked ducts.

## Smart Diagnosis™

Should you experience any technical difficulty with your dryer, it has the capability of transmitting data via your telephone to the Customer Information Center. The call center agent records the data transmitted from your machine and uses it to analyze the issue, providing a fast and effective diagnosis.

## Tag On (on some models)

The Tag On feature works on most smart phones equipped with the NFC function and based on the Android operating system (OS).

Using the LG Smart Laundry application, the Tag On feature will allow you to diagnose your appliance, download new cycles, and see the status of your appliance by simply touching the smart phone to the Tag On logo of the appliance.



**Protocol P154**  
**Sanitization Performance of**  
**Residential Clothes dryer**

# SAFETY INSTRUCTIONS

## *READ ALL INSTRUCTIONS BEFORE USE*

### Your safety and the safety of others is very important.

We have provided many important safety messages in this manual and on your appliance. Always read and obey all safety messages.



This is the safety alert symbol.

This symbol alerts you to potential hazards that can kill or hurt you and others.

All safety messages will follow the safety alert symbol and either the word DANGER, WARNING, or CAUTION.

These words mean:



**DANGER** - You will be killed or seriously injured if you do not immediately follow instructions.



**WARNING** - You may be killed or seriously injured if you do not follow instructions.



**CAUTION** - You may be slightly injured or cause damage to the product if you do not follow instructions.

All safety messages will tell you what the potential hazard is, tell you how to reduce the chance of injury, and tell you what may happen if the instructions are not followed.



## WARNING – Risk of Fire

Install the clothes dryer according to the manufacturer's instructions and local codes.

- Clothes dryer installation must be performed by a qualified installer.
- Do not install a clothes dryer with flexible plastic venting materials. If flexible metal (foil type) duct is installed, it must be of a specific type identified by the appliance manufacturer as suitable for use with clothes dryers. Flexible venting materials are known to collapse, be easily crushed, and trap lint. These conditions will obstruct clothes dryer airflow and increase the risk of fire.
- To reduce the risk of severe injury or death, follow all installation instructions.
- Save these instructions.



### WARNING

For your safety the information in this manual must be followed to minimize the risk of fire or explosion or to prevent property damage, personal injury or death.

- Do not store or use gasoline or other flammable vapors and liquids in the vicinity of this or any other appliance.
- WHAT TO DO IF YOU SMELL GAS
  - a. Do not try to light any appliance.
  - b. Do not touch any electrical switch; do not use any phone in your building.
  - c. Clear the room, building or area of all occupants.
  - d. Immediately call your gas supplier from a neighbor's phone. Follow the gas supplier's instructions.
  - e. If you cannot reach your gas supplier, call the fire department.
- Installation and service must be performed by a qualified installer, service agency or your gas supplier.



# IMPORTANT SAFETY INSTRUCTIONS



## WARNING

To reduce the risk of fire, electric shock, or injury to persons when using your appliance, follow basic precautions, including the following:

### Installation

- Keep area around the exhaust opening and adjacent surrounding areas free from the accumulation of lint, dust, and dirt.
- Do not install or store this appliance where it will be exposed to the weather.
- **Do not place items exposed to cooking oils in your dryer.** Items contaminated with cooking oils may contribute to a chemical reaction that could cause a load to catch fire.
- **Properly ground the dryer to conform with all governing codes and ordinances.** Follow the details in the installation instructions. Electric shock may result if the dryer is not properly grounded.
- **Before use, the dryer must be properly installed as described in this manual.** Electric shock may result if the dryer is not properly grounded.
- Install and store the dryer where it will not be exposed to temperatures below freezing or exposed to the weather.
- **All repairs and servicing must be performed by authorized service personnel unless specifically recommended in this Owner's Manual. Use only authorized factory parts.** Failure to follow this warning may result in serious injury, fire, electric shock, or death.
- **To reduce the risk of electric shock, do not install the dryer in humid spaces.** Failure to follow this warning may result in serious injury, fire, electric shock, or death.
- **Connect to a properly rated, protected, and sized power circuit to avoid electrical overload.** Improper power circuits may melt, creating electric shock and/or fire hazard.
- **Remove all packing items and dispose of all shipping materials properly.** Failure to do so may result in burns, fire, explosion, or death.
- **Place the dryer at least 18-inch (45.7 cm) above the floor for a garage installation.** Failure to do so may result in burns, fire, explosion, or death.
- **Keep all packaging from children.** Packaging material can be dangerous for children. There is a risk of suffocation.
- **Do not install near another heat source such as a stove, oven or heater.** Failure to follow this warning may result in product deformation, smoke, or fire.
- Do not place candles, smoking materials, or other flammables on top of the product. Dripping wax, smoke, or fire may result.
- **Remove all protective vinyl film from the product.** Failure to do so may result in product damage, smoke, or fire.
- **Gas dryers MUST be exhausted to the outside.** Failure to follow these instructions may result in fire or death.
- The dryer exhaust system must be exhausted to the outside of the dwelling. If the dryer is not exhausted outdoors, some fine lint and large amounts of moisture will be expelled into the laundry area. An accumulation of lint in any area of the home may create a health and fire hazard.
- Use only rigid, semi-rigid or flexible metal 4-inch (10.2 cm) diameter duct inside the dryer cabinet or for exhausting to the outside. Use of plastic or other combustible ductwork may cause fire. Punctured ductwork may cause fire if it collapses or becomes otherwise restricted in use or during installation.
- **Ductwork is not provided with the dryer, and you should obtain the necessary ductwork locally. The end cap should have hinged dampers to prevent backdraft when the dryer is not in use.** Failure to follow these instructions may result in fire or death.
- **The exhaust duct must be 4-inch (10.2 cm) in diameter with no obstructions. The exhaust duct should be kept as short as possible. Make sure to clean any old ducts before installing your new dryer.** Failure to follow these instructions may result in fire or death.
- **Rigid, semi-rigid or flexible metal ducting is recommended for use between the dryer and the wall. All non-rigid metal transition duct must be UL-listed. Use of other materials for transition duct could affect drying time.** Failure to follow these instructions may result in fire or death.
- **Do not use sheet metal screws or other fasteners which extend into the duct that could catch lint and reduce the efficiency of the exhaust system. Secure all joints with duct tape. For complete details, follow the Installation Instructions.** Failure to follow these instructions may result in fire or death.
- Certain internal parts are intentionally not grounded and may present a risk of electronic shock only during serving. Service personnel - do not contact the following parts while the appliance is energized: CONTROL BOARD

### Operation

- Read all instructions before using the appliance.
- Do not dry articles that have been previously cleaned in, washed in, soaked in, or spotted with gasoline, dry-cleaning solvents, or other flammable or explosive substances, as they give off vapors that could ignite or explode.
- Do not reach into the appliance if the drum is moving.
- Do not allow children to play on or in the appliance. Close supervision of children is necessary when the appliance is used near children.
- Do not use fabric softeners or products to eliminate static unless recommended by the manufacturer of the fabric softener or product.
- Do not use heat to dry articles containing foam rubber or similarly textured rubber-like materials.
- Do not tamper with controls.
- Always check the inside of the dryer for foreign objects. Failure to follow these instructions may result in fire or death.
- Do not store plastic, paper, or clothing that may burn or melt on top of the dryer during operation. Failure to follow these instructions may result in fire or death.
- Be careful when opening and closing the door. Fingers and hands can get caught in the door and cause injury if the door drops forward unexpectedly.
- **Do not place heavy items on or lean against the top of the door when it is open.**
- **Do not attempt to pull the hamper door open more than 40 degrees.**
- The dryer could tip forward, causing injury or damage.
- Do not place items on the top of the dryer.

### Steam (steam model):

- **Do not open the dryer door during steam cycles.** Failure to follow these instructions may result in a burn hazard.
- **Do not dry articles that have been previously cleaned in, washed in, soaked in, or spotted with gasoline, dry-cleaning solvents, or other flammable or explosive substances as they give off vapors that could ignite or explode.** Failure to follow these instructions may result in fire or death.

- **Do not fill the steam feeder with gasoline, dry cleaning solvents, or other flammable or explosive substances.** Failure to follow these instructions may result in fire or death.
- **Do not touch the steam nozzle in the drum during or after the steam cycles.** Failure to follow these instructions may result in a burn hazard.
- **Do not fill the steam feeder with hot water (over 86 °F/30 °C).** Failure to follow these instructions may result in a burn hazard.

### Maintenance

- Do not repair or replace any part of the appliance or attempt any servicing unless specifically recommended in the user maintenance instructions or in published user-repair instructions that you understand and have the skills to carry out.
- Clean the lint filter before or after each load.
- The interior of the appliance and exhaust duct should be cleaned periodically by qualified service personnel.
- Before the appliance is removed from service or discarded, remove the door to the drying compartment.
- Certain internal parts are intentionally not grounded and may present a risk of electronic shock only during serving. Service personnel - do not contact the following parts while the appliance is energized: CONTROL BOARD

**SAVE THESE INSTRUCTIONS**

## GROUNDING INSTRUCTIONS

### WARNING

Improper connection of the equipment-grounding conductor may result in a risk of electric shock. Check with a qualified electrician or service person if you are in doubt that the appliance is properly grounded.

- **This appliance must be grounded.** In the event of malfunction or breakdown, grounding will reduce the risk of electric shock by providing a path of least resistance for electric current.
- **This appliance must be equipped with a cord having an equipment-grounding conductor and a grounding plug.** The plug must be plugged into an appropriate outlet that is properly installed and grounded in accordance with all local codes and ordinances.
- **Do not modify the plug.** If it will not fit the outlet, have a proper outlet installed by a qualified electrician.
- **This appliance must be connected to a grounded metal, permanent wiring system or an equipment-grounding conductor must be run with the circuit conductors and connected to the equipment-grounding terminal or lead on the appliance.** Electric shock may result if the dryer is not properly grounded.
- **The dryer should always be plugged into its own individual electrical outlet which has a voltage rating that matches the rating plate.** This provides the best performance and also prevents overloading house wiring circuits which can cause a fire hazard from overheated wires.
- **Never unplug your dryer by pulling on the power cord. Always grip the plug firmly and pull straight out from the outlet.** The power cord may be damaged, resulting in a risk of fire and electric shock.
- **Repair or replace immediately all power cords that have become frayed or otherwise damaged. Do not use a cord that shows cracks or abrasion damage along its length or at either end.** The power cord may melt, creating electric shock and/or fire hazard.
- **When installing or moving the dryer, be careful not to pinch, crush, or damage the power cord.** This will prevent injury and damage to the dryer from fire and electric shock.
- **Do not, under any circumstances, cut or remove the ground prong from the power cord.** To prevent personal injury or damage to the dryer, the electrical power cord must be plugged into a properly grounded outlet.
- **For personal safety, this dryer must be properly grounded.** Failure to do so may result in electric shock or injury.
- **Refer to the installation instructions in this manual for specific electrical requirements for your model.** Failure to follow these instructions may create an electric shock hazard and/or a fire hazard.
- **This dryer must be plugged into a properly grounded outlet. Electrical shock may result if the dryer is not properly grounded. Have the wall outlet and circuit checked by a qualified electrician to make sure the outlet is properly grounded.** Failure to follow these instructions may create an electric shock hazard and/or a fire hazard.

## • CALIFORNIA SAFE DRINKING WATER AND TOXIC ENFORCEMENT ACT

- This act requires the Governor of California to publish a list of substances known to the state to cause cancer, birth defects, or other reproductive harm and requires businesses to warn customers of potential exposure to such substances.
- Gas appliances can cause minor exposure to four of these substances, namely benzene, carbon monoxide, formaldehyde, and soot, caused primarily by the incomplete combustion of natural gas or LP fuels.
- Properly adjusted dryers will minimize incomplete combustion. Exposure to these substances can be minimized further by properly venting the dryer to the outdoors.



### **WARNING**

This product contains chemicals known to the State of California to cause cancer and birth defects or other reproductive harm. ***Wash hands after handling.***

# PRODUCT OVERVIEW

## Parts

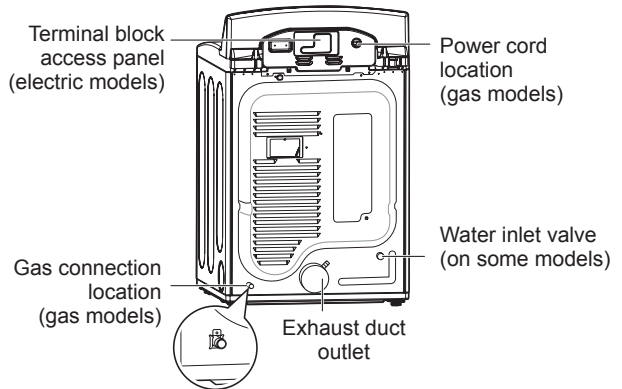
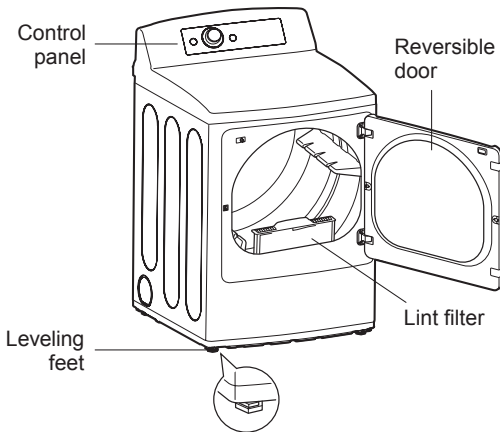

## Accessories

### Included Accessories

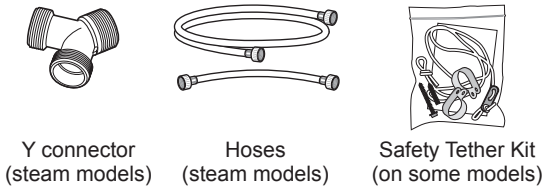

### Optional accessories

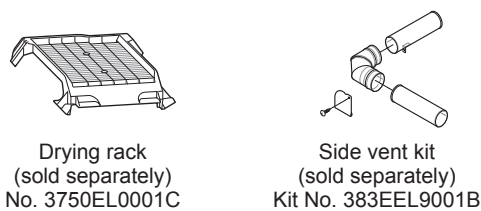

## Two-Way Reversible Door (on some models)

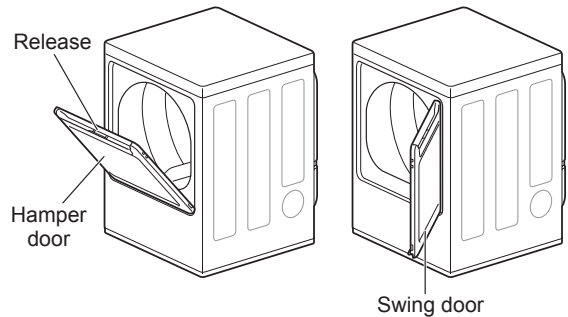

The LG EasyLoad™ feature allows you to open the dryer door from the top, hamper-style, when loading the dryer to help guide clothes into the drum and prevent them from falling onto the floor. When unloading the dryer or loading bulkier items, use the swing door for easy access to the drum.

## Safety Tether Kit

This optional kit helps prevent the dryer tipping if children climb on the door or if someone should fall onto the door. It is recommended that you install this kit, depending on your situation, but it is not required. Follow the customer installation instructions included with the kit to properly install the kit. If you do not install the kit, store it out of reach of children.

### NOTE

- For your safety and for extended product life, use only authorized components. The manufacturer is not responsible for product malfunction or accidents caused by the use of separately purchased unauthorized components or parts.
- The images in this guide may be different from the actual components and accessories, which are subject to change by the manufacturer without prior notice for product improvement purposes.

# INSTALLATION

## Installation Overview

Please read the following installation instructions first after purchasing this product or transporting it to another location.

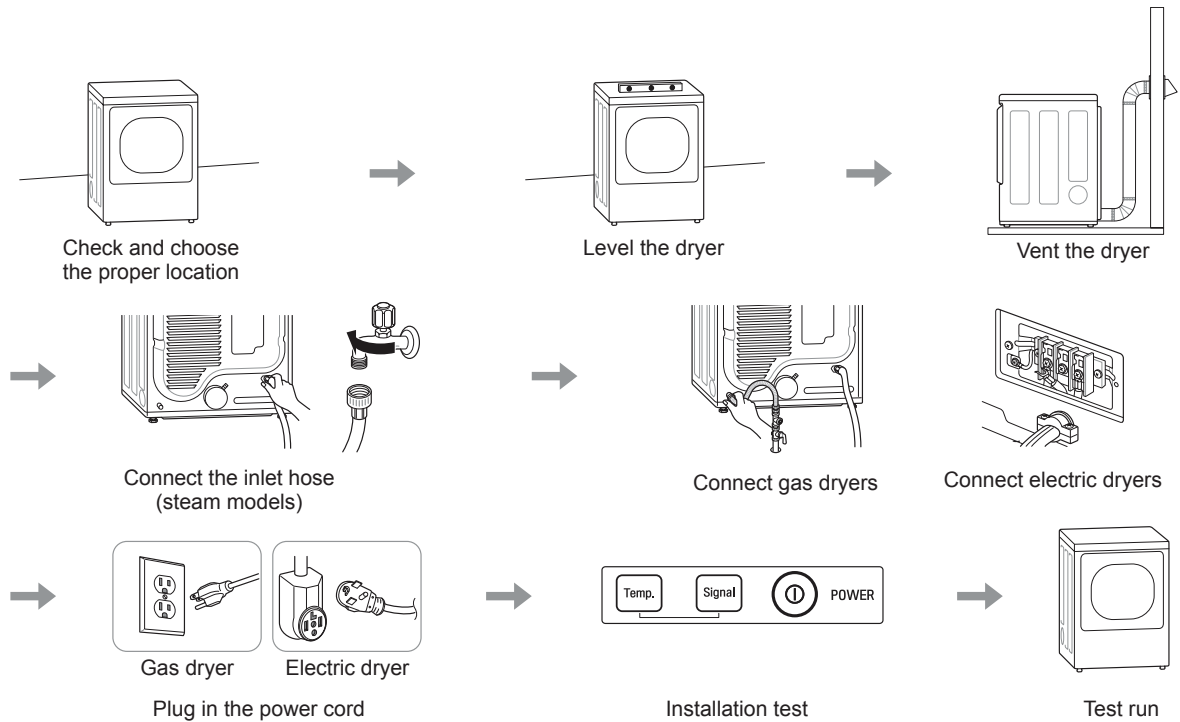

## Product Specifications

The appearance and specifications listed in this manual may vary due to constant product improvements.

Dryer Models	DLEX7600*, DLGX7601*
Description	Steam Dryer
Electrical requirements	Please refer to the rating label regarding detailed information.
Gas requirements	NG: 4–10.5-inch WC LP: 8–13-inch WC
Max. water pressure	20–120 psi (138–827 kPa)
Dimensions	27" (W) X 28 15/16" (D) X 40 3/16" (H), 50 1/4" (D with door open) 68.6 cm (W) X 73.4 cm (D) X 102 cm (H), 127.5 cm (D with door open)
Net weight	Gas dryer : 132.52 lb (60.11 Kg) Electric dryer : 129.76 lb (58.86 Kg)
Drying capacity - Normal cycle - Steam cycle	IEC 7.3 cu.ft. (22.5 lb/10.2 kg) IEC 7.3 cu.ft.(8 lbs/3.6kg)

## Installation Location Requirements

### WARNING

Read all installation instructions completely before installing and operating your dryer! It is important that you review this entire manual before installing and using your dryer. Detailed instructions concerning electrical connections, gas connections, and exhaust requirements are provided on the following pages.

The installation requires:

- A location that allows for proper exhaust installation. A gas dryer must be exhausted to the outdoors. See Venting the Dryer.
- A grounded electrical outlet located within 2 ft. (61 cm) of either side of the dryer. See Connecting Electric Dryers .
- A sturdy floor to support the total dryer weight of 200 lb (90.7 kg). The combined weight of a companion appliance should also be considered.
- No other fuel-burning appliance can be installed in the same closet as a dryer.

Do not operate your dryer at temperatures below 45 °F (7 °C). At lower temperatures, the dryer might not shut off at the end of an automatic cycle. This can result in longer drying times. The dryer must not be installed or stored in an area where it will be exposed to water and/or weather. Check code requirements. Some codes limit, or do not permit, installation of the dryer in garages, closets, mobile homes or sleeping quarters. Contact your local building inspector.

### NOTE

- The floor must be level, with a maximum slope of 1 inch (2.5 cm) under the entire dryer. Clothes may not tumble properly, and automatic sensor cycles may not operate correctly if dryer is not level.
- For a garage installation, you will need to place the dryer at least 18-inch (46 cm) above the floor. The standard pedestal is 15-inch (38.1 cm). You will need 18-inch (46 cm) from the garage floor to the bottom of the dryer.

## Clearances

### Installation Spacing for Recessed Area or Closet Installation

The following spacing dimensions are recommended for this dryer. This dryer has been tested for clearances of 1 inch (2.5 cm) on the sides and rear. Recommended clearances should be considered for the following reasons:

- Additional clearances should be considered for ease of installation and servicing.
- Additional clearances might be required for wall, door and floor moldings.
- Additional clearances should be considered on all sides of the dryer to reduce noise transfer. For closet installation, with a door, minimum ventilation openings in the top and bottom of the door are required. Louvered doors with equivalent ventilation openings are acceptable.
- Companion appliance spacing should also be considered.

### Closet Ventilation Requirements

Closets with doors must have both an upper and lower vent to prevent heat and moisture buildup in the closet. One upper vent opening with a minimum opening of 48 sq. in. (310 cm<sup>2</sup>) must be installed no lower than 6 feet above the floor. One lower vent opening with a minimum opening of 24 sq. in. (155 cm<sup>2</sup>) must be installed no more than one foot above the floor. Install vent grills in the door or cut down the door at the top and bottom to form openings. Louvered doors with equivalent ventilation openings are also acceptable.

**NOTE**

There should be at least a little space around the dryer (or any other appliance) to eliminate the transfer of vibration from one appliance to another. If there is enough vibration, it could cause appliances to make noise or come into contact, causing paint damage and further increasing noise.

### Installation Spacing for Recessed Area or Closet

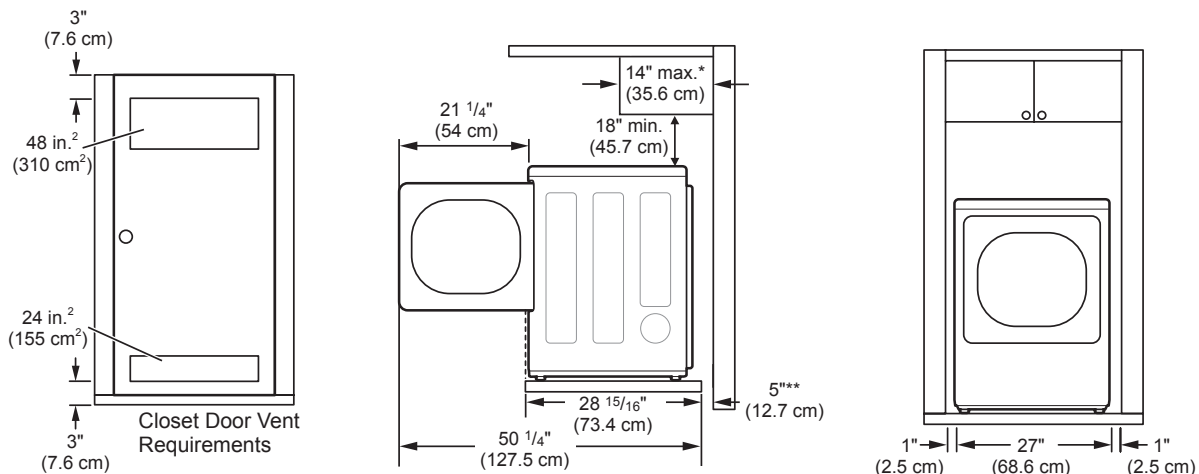

\* Required spacing

\*\* For side or bottom venting, 2-inch (5.1 cm) of spacing is allowed

### Installation Spacing for Cabinet

For cabinet installation with a door, minimum ventilation openings in the top of the cabinet are required.

\* Required spacing

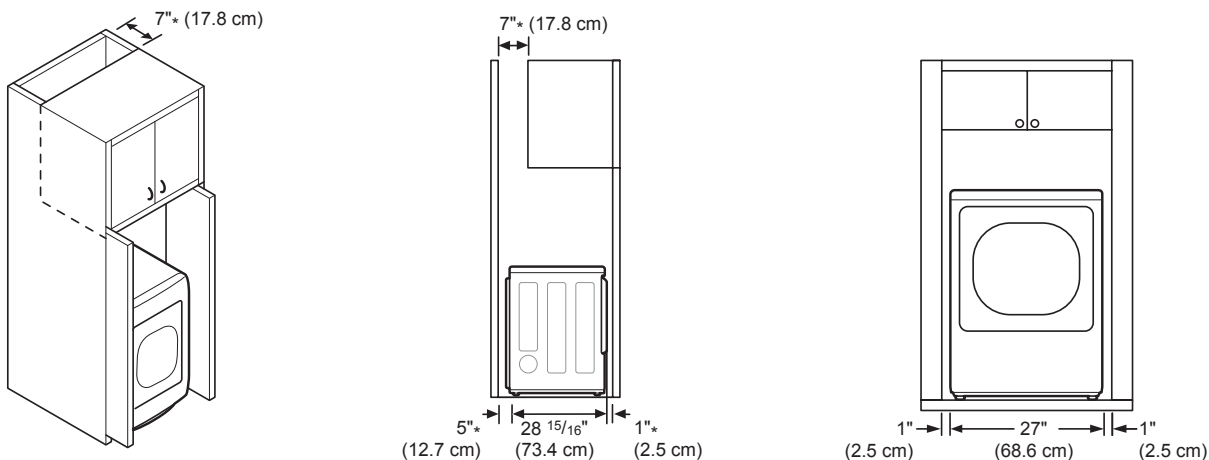



## Leveling the Dryer

### **WARNING**

To reduce the risk of injury to persons, adhere to all industry recommended safety procedures including the use of long-sleeved gloves and safety glasses. Failure to follow this warning may result in serious injury or death.

- The appliance is heavy. Two or more people are required when installing the dryer. Failure to follow this warning may result in serious injury or death.
- To ensure that the dryer provides optimal drying performance, it must be level. To minimize vibration, noise, and unwanted movement, the floor must be a perfectly level, solid surface.

### **NOTE**

Adjust the leveling feet only as far as necessary to level the dryer. Extending the leveling feet more than necessary may cause the dryer to vibrate.

- 1 Position the dryer in the final location. Place a level across the top of the dryer.

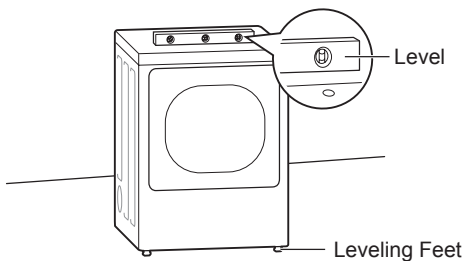

- All four leveling feet must rest solidly on the floor. Gently push on the top corners of the dryer to make sure that the dryer does not rock from corner to corner.

If you are installing the dryer on the optional pedestal, you must use the leveling feet on the pedestal to level the dryer. The dryer leveling feet should be fully retracted.

- 2 Use an adjustable wrench to turn the leveling feet. Unscrew the legs to raise the dryer or screw in the legs to lower it. Raise or lower with the leveling feet until the dryer is level from side to side and front to back. Make sure that all four leveling feet are in firm contact with the floor.

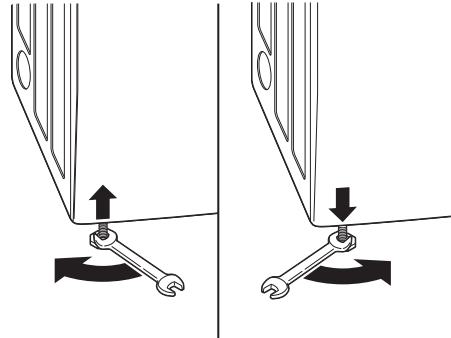

## Reversing the Door

### Before you Begin

#### **NOTE**

**Service calls to reverse the door are not covered under the product warranty.**

- The door reversal process for the two-way door is more complex than for a conventional dryer door. Read through these instructions in their entirety before beginning the process, in order to gauge whether to have the procedure done by a professional installer or service person.
- A support video is also provided at <http://www.lg.com/us/support/videos/video-tutorials-view>, How to Reverse the Door – LG EasyLoad™ Dryer.

### Tools Required

- **Phillips screwdriver**
- **Large flat blade screwdriver** (recommended for hinge screws if they are tight or your Phillips screwdriver is worn)
- **Small flat blade screwdriver** (for lifting out parts)

### **WARNING**

THE DRYER DOOR IS VERY LARGE AND HEAVY. Failure to follow the instructions below may result in damage to the dryer, property damage or personal injury.

- To avoid damage to the dryer or the door, support the door with a stool or box that fits under the door, or have an assistant support the weight of the door.
- Avoid dropping the door to avoid damage to the door or the floor.
- Unplug the dryer or turn off power at the main circuit breaker before beginning door reversal.

## Door Reversal Instructions

### NOTE

The instructions here are for changing the door swing from a right to a left side hinge. If the door has been reversed, and it is necessary to change it back, use care when following these instructions. Some of the illustrations and the left/right references will be reversed, and you will need to read the instructions carefully.



### WARNING

Be sure to support the weight of the door before removing the hinge screws.

## Swing door

- 1 **Open the door from the side so that the hinge screws are accessible.**

- 2 **Remove the four hinge screws.**

While supporting the door, remove the four hinge screws, two from each hinge. Set the door aside face down on a protected surface to prevent damage to the door or the work surface.

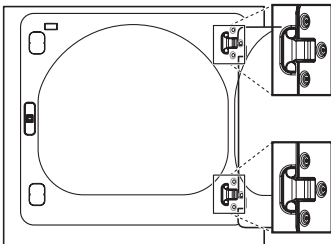

- 3 **Reverse the components on the cabinet.**

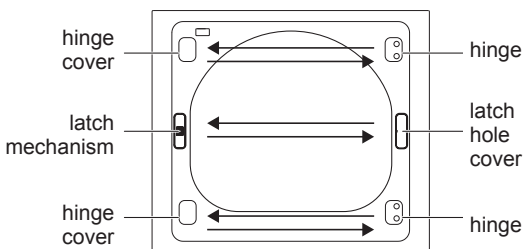

- a. Use a Phillips screwdriver to remove the two screws and the latch mechanism on the front panel of the cabinet.
- b. Remove the latch hole cover by gently prying it up with a flat blade screwdriver, being careful not to scratch the paint. Install the latch hole cover on the opposite side, where the latch mechanism was removed. Install the latch mechanism in the position from which you removed the latch hole cover, using the two screws removed in step a.

- c. Remove the hinge cover by gently prying it up with a flat blade screwdriver, being careful not to scratch the paint. Rotate the hinge cover 180 degrees and install it on the opposite side, where the hinge was attached.

- 4 With the door on a protected surface, remove the 16 screws on each side of the door and lift off the inner door frame using a flat blade screwdriver. Remove the latch hook and blank and install them on the opposite side.

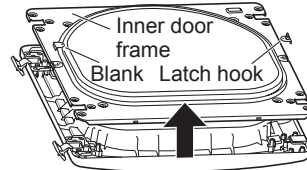

- 5 Remove the 4 screws securing the hinges to the door frame. Remove the two plastic cover caps. Reinstall the hinges and cover caps on the opposite sides from which they were removed.

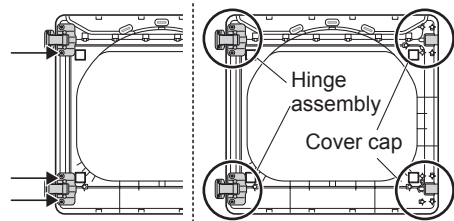

- 6 With the hinges and cover caps in the new locations, remount the inner door frame onto the outer door frame with the screws removed in step 4 above.

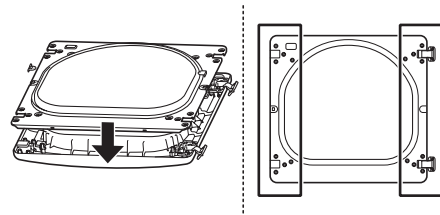

### WARNING

Be sure to support the weight of the door before installing the hinge screws.

### 7 Reinstall the door.

While supporting the door, install the four hinge screws removed in step 2. Test the swing of the door to make sure the hinges and latch are properly aligned and that the door opens, closes and latches properly in both directions.

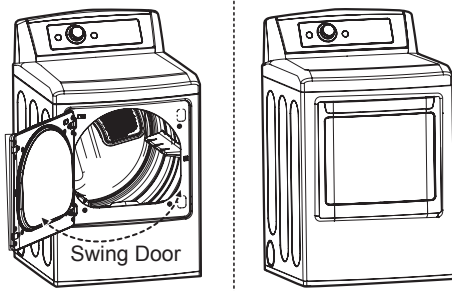

### Easy load door (on some models)

#### **WARNING**

Be sure to support the weight of the door before installing the hinge screws.

ON THE CABINET :

### 1 Open the door from the side so that the hinge screws are accessible.

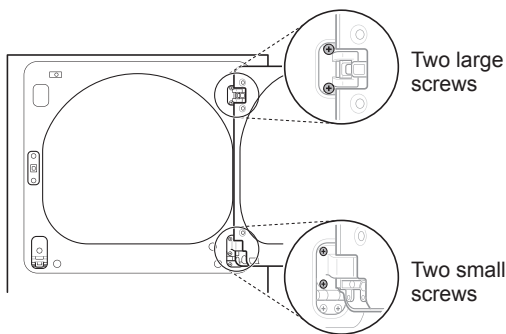

### 2 Remove the four hinge screws

While supporting the door, remove the four hinge screws, two from each hinge. Set the door aside face down on a protected surface to prevent damage to the door or the work surface.

### 3 Reverse the components on the cabinet.

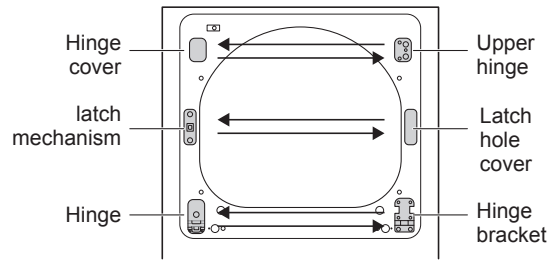

- Use a Phillips screwdriver to remove the two screws and the latch mechanism on the front panel of the cabinet.
- Remove the latch hole cover by gently prying it up with a flat blade screwdriver, being careful not to scratch the paint. Install the latch hole cover on the opposite side, where the latch mechanism was removed. Install the latch mechanism in the position from which you removed the latch hole cover, using the two screws removed in step a.
- Remove the hinge cover by gently prying it up with a flat blade screwdriver, being careful not to scratch the paint. Rotate the hinge cover 180 degrees and install it on the opposite side, where the upper hinge was attached.
- Reverse the hinge and the hinge bracket at the bottom of the cabinet. Remove the two screws from the hinge bracket at the bottom right and remove the hinge bracket. Remove the lower of the two screws behind the hinge bracket. Do NOT remove the upper screw behind the hinge bracket. Set the parts aside.

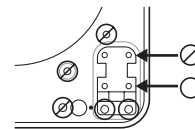

#### **CAUTION**

Do NOT remove any of the eight screws on the face of the cabinet (marked below). Doing so could result in damage to the dryer and the need for a service call to repair the dryer.

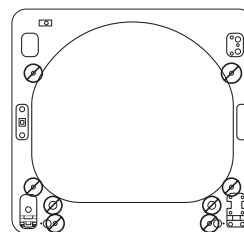

- e. Remove the three screws on the hinge at the bottom left. Remove the hinge and reinstall it on the right side. The top screw will occupy the hole where you removed the screw behind the hinge bracket in step d.

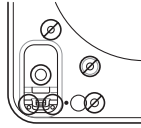

- f. Install the hinge bracket removed in step d on the bottom left side, first installing one screw behind the hinge bracket.

Cabinet Reversal complete

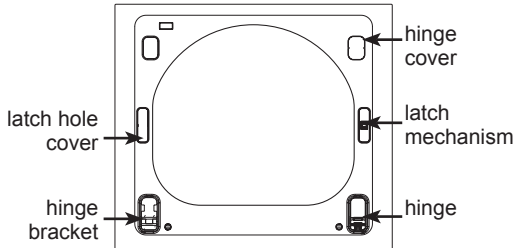

ON THE DOOR:

**4 Lift off the door cover.**

With the door laid inside facing up on a protected surface, remove the twelve screws on the inside of the door. Carefully lift off the door cover with the help of a small flat blade screwdriver inserted in the upper corner (circled below).

**WARNING**

The edges of the door cover may be sharp. Take care when handling, or wear gloves to avoid injury.

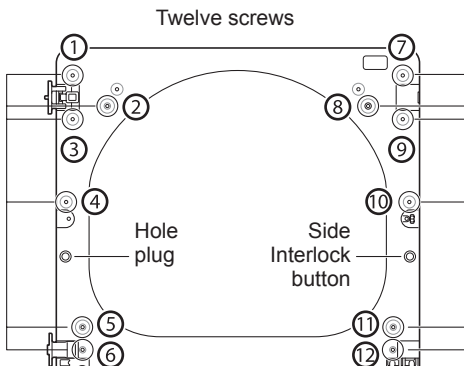

**5 Switch the door strike and the blank cover.**

Remove the two screws on the door cover that secure the door strike.

Switch the door strike and the blank cover, installing them on the opposite sides from which they were removed.

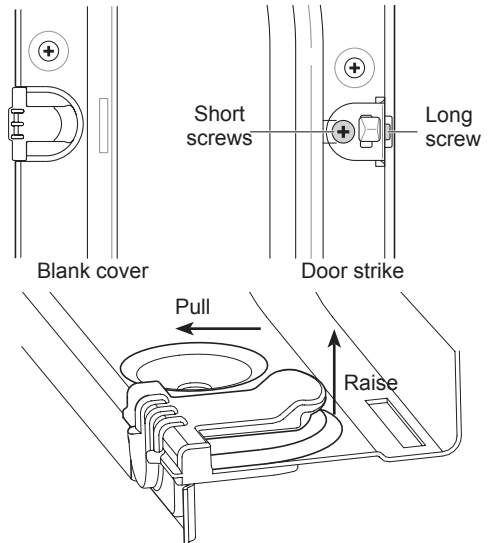

Remove blank cover

Gently pry out the hole plug on the side of the door cover and install it in the hole on the opposite side.

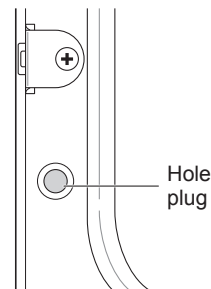

Set the door cover aside.

**6 Reverse the components inside the door.**

You will now be removing and reversing various components inside the door. See below for a detailed diagram and identification of the inner structure and parts of the door. (The diagram shows the “before view” of the door, with the default set-up for a right side hinge swing. After following these instructions, your door should be a mirror image of the illustration.)

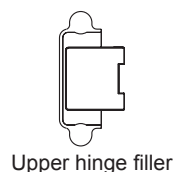
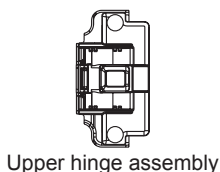
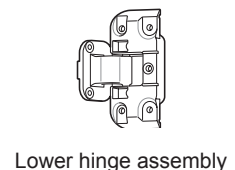
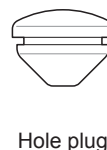
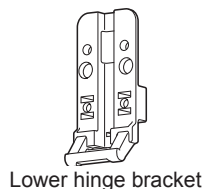
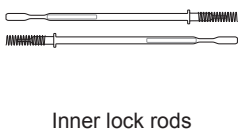
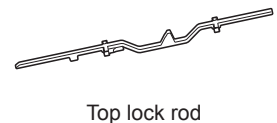
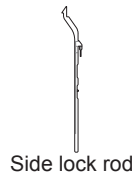
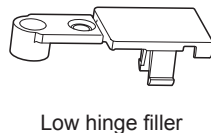
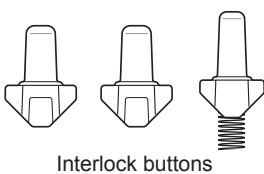
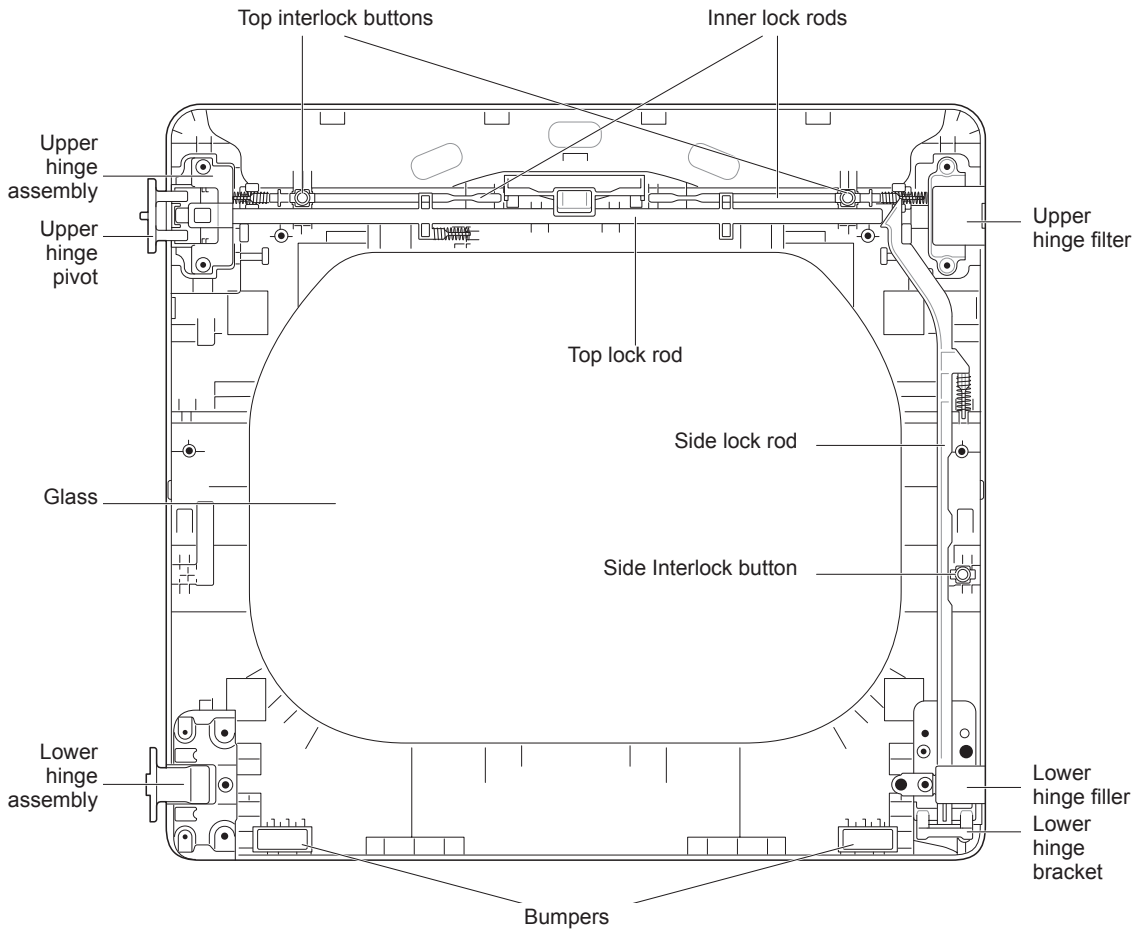

**7 Lift out the gray interlock button in the side of the door.**

Make sure to remove the spring with the interlock button and to keep the two together. Set the interlock button aside. Do not confuse these with the interlock buttons from the top of the outer door.

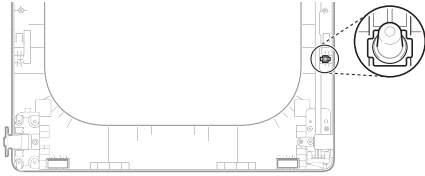

**8 Remove the side lock rod.**

Remove the side lock rod from the lower hinge bracket by lifting the top end of the rod and sliding it toward the top of the door. The spring should remain attached to the lock rod. Set the lock rod aside.

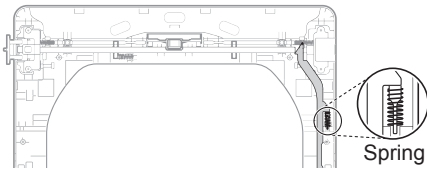

**9 Remove the top lock rod.**

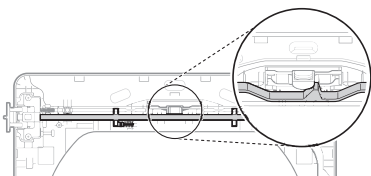

a. Slide the lock rod to the right to remove it from the hinge assembly on the left side.

b. While sliding the lock rod right, lift the right end up and out of the guides.

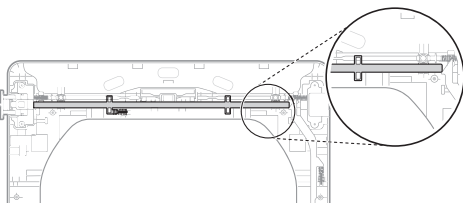

**NOTE**

Do not remove the two inner lock rods and two interlock buttons (see page 17) located underneath the top lock rod. They do NOT need to be reversed.

**10 Remove the upper hinge pivot.**

Once the top lock rod has been removed, the hinge pivot can easily be removed from the hinge assembly on the upper left and set aside.

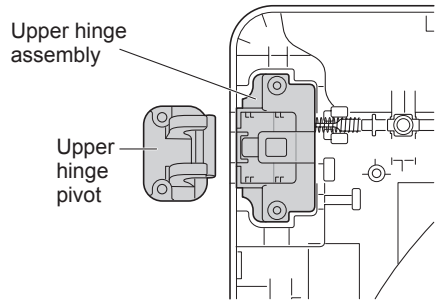

**11 Reverse the upper hinge assembly and hinge filler.**

Lift out the upper hinge filler (on the right) and set it aside.

Carefully lift the upper hinge assembly (on the left) out of the outer door frame, using a small flat blade screwdriver if necessary. Rotate the hinge assembly 180 degrees and install it on the upper right side of the outer door. You will need to press firmly to install the hinge assembly.

The hinge pivot removed in step 11 will be installed later.

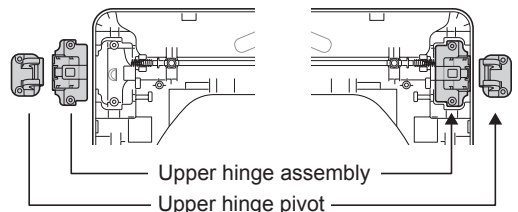

Now rotate the hinge filler 180 degrees and install it on the upper left side of the door.

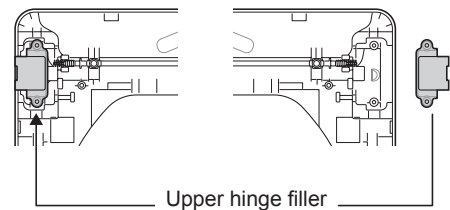

## 12 Reinstall the top lock rod.

Rotate the top lock rod (removed in step 10) 180 degrees end for end from its original position and reinstall it. The spring should now be to the right of center, with the spring on the side of the rod facing the top of the door.

- a. Insert the right end of the lock rod into the right hinge assembly. Make sure the rod is aligned with the guides in the door panel.

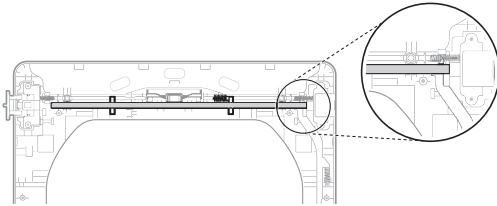

- b. Lower the rod into position, sliding it to bypass the center handle, making sure to align the lock rod with the guides all the way across the door panel. When released, the lock rod should slide completely into the hinge assembly on the right. Slide the lock rod back and forth to make sure it is correctly positioned in the guides and slides easily.

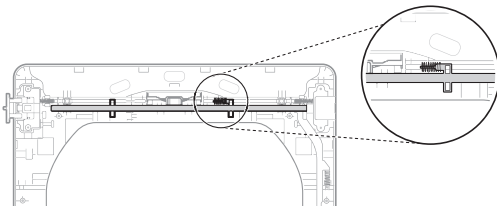

## 13 Reverse the lower hinge bracket and hinge assembly.

- a. Remove the screw from the lower hinge bracket (on the right) and lift the hinge bracket out. Set it aside. Remove the two screws from the lower hinge assembly on the bottom left and lift the hinge assembly out.

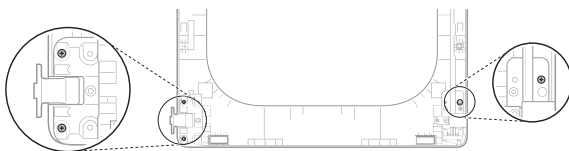

- b. Rotate the lower hinge assembly 180 degrees and install it on the right side using the two screws removed in step a.

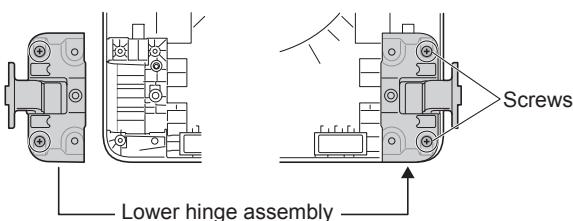

- c. Flip over the lower hinge bracket and release the tabs on the back locking the hinge filler to the hinge bracket.

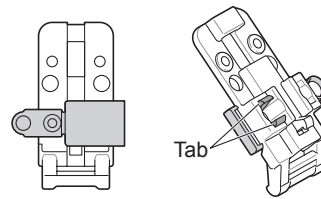

- d. Rotate the hinge 180 degrees and snap it back onto the front of the hinge bracket facing in the opposite direction.

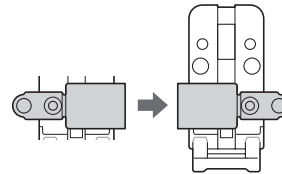

- e. Mount the lower hinge bracket and the filler on the left side of the door with the screw removed in step a.

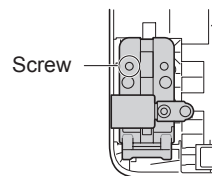

## 14 Install the side lock rod.

Flip the side lock rod over and install it on the opposite side. Insert the lower end into the left hinge and lower the rod into the guides on the door while compressing the spring inside the recess.

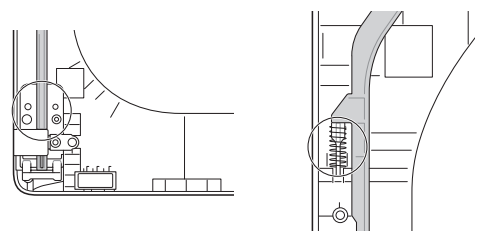

Make sure the top of the side lock rod is beside the top lock rod and the two do not overlap each other, so the two rods can interact correctly. If they are not aligned properly, the door will not operate properly.

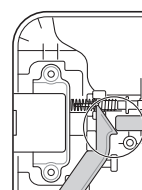



**15 Reinstall the side interlock button.**

Reinstall the side interlock button removed in step 7. Center the spring in the compartment and insert the interlock button on top of it.

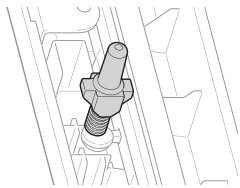
**16 Reinstall the door cover.**

Clean the glass on the door and door cover, if necessary.

Make sure the three gray interlock buttons are properly installed and that the top and side lock rods are properly aligned where they meet. Carefully lower the door cover into place, aligning the holes in the cover with the interlock buttons on the top and side and the bumpers on the bottom. Take care not to dislodge the lock rods while mounting the door cover. Once the door cover is in place, secure it with the 12 screws removed in step 4. The ten similar screws go around the top and sides of the door cover. Make sure to install the two different screws on the bottom edge, in the locations marked below.

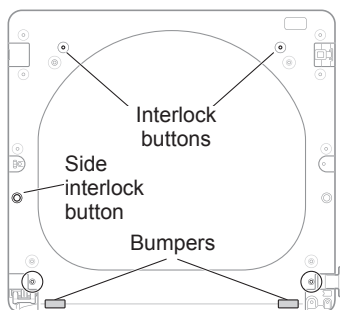
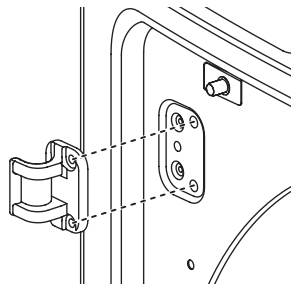
**17 Now, pick up the upper hinge pivot removed earlier and rotate it 180 degrees. Install the hinge on the top left side of the cabinet.****18 Reinstall the door.**

Press in the side interlock button on the left side and hold it down while you press the hinge pivot into the hinge assembly on the top right side. If the door has been reassembled correctly, the lock rod will slide back easily and lock the pivot in place. The door is now ready to remount on the opposite side of the dryer.

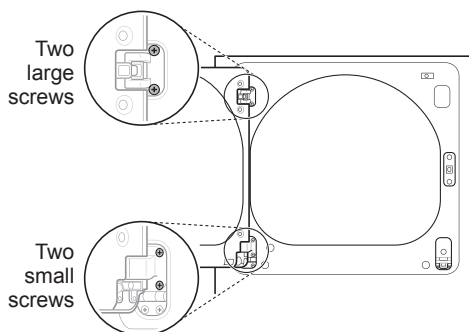

While supporting the door, install the two small hinge screws removed in step 2. Test the swing of the door to make sure the hinges and latch are properly aligned and that the door opens, closes and latches properly in both directions.

If the door doesn't operate smoothly, remove the door and then the door cover to check that the lock rods and interlock buttons are properly mounted and aligned.

The interlock buttons should be oriented correctly and operating smoothly. The interlock rods should be in the proper position and should not overlap at the contact point. (See steps 15-17.)

If the door is damaged, or if the door does not work after reassembly, contact the call center at 1-800-243-0000.



# Installing the Side Vent Kit

## ⚠ WARNING

- Use a heavy metal vent.
- Do not use plastic or thin foil ducts.
- Clean old ducts before installing this dryer.
- To reduce the risk of injury to persons, adhere to all industry recommended safety procedures including the use of long-sleeved gloves and safety glasses.
- Failure to follow all of the safety warnings in this manual could result in property damage, injury to persons, or death.

Your new dryer is shipped to vent to the rear. It can also be configured to vent to the bottom or side (right-side venting is not available on gas models).

An adapter kit, part number 383EEL9001B, may be purchased from your LG retailer. This kit contains the necessary duct components to change the dryer vent location.

- 1 Remove the rear exhaust duct retaining screw. Pull out the exhaust duct.

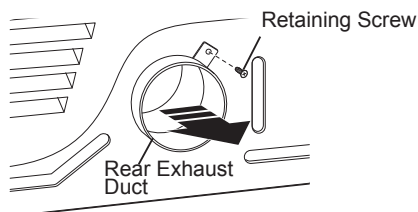

## Option 1: Side Venting

- 2 Press the tabs on the knockout and carefully remove the knockout for the desired vent opening (right-side venting is not available on gas models). Press the adapter duct onto the blower housing and secure to the base of the dryer as shown.

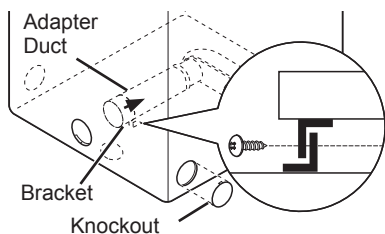

- 3 Preassemble a 4-inch (10.2 cm) elbow to the next 4-inch (10.2 cm) duct section, and secure all joints with duct tape. Be sure that the male end of the elbow faces AWAY from the dryer. Insert the elbow/duct assembly through the side opening and press it onto the adapter duct. Secure it in place with duct tape. Be sure that the male end of the duct protrudes 1½-inch (3.8 cm) to connect the remaining ductwork. Attach the cover plate to the back of the dryer with the included screw.

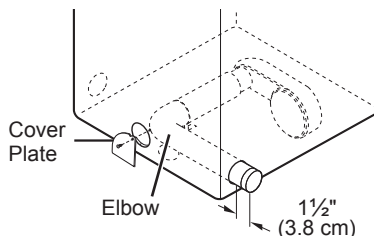

## Option 2: Bottom Venting

- 2 Press the adapter duct onto the blower housing and secure it to the base of the dryer as shown.

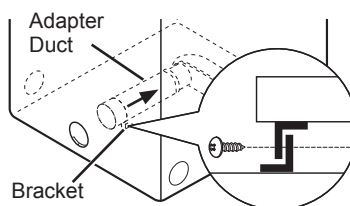

- 3 Insert the 4-inch (10.2 cm) elbow through the rear opening and press it onto the adapter duct. Be sure that the male end of the elbow faces down through the hole in the bottom of the dryer. Secure it in place with duct tape. Attach the cover plate to the back of the dryer with the included screw.

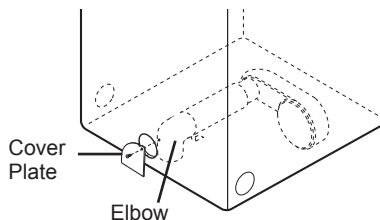

## Venting the Dryer



### WARNING

To reduce the risk of fire or explosion, electric shock, property damage, injury to persons or death when using this appliance, follow basic safety precautions, including the following:

- **Do not crush or collapse ductwork.** Failure to follow these instructions may result in fire or death.
- **Do not allow ductwork to rest on or contact sharp objects.** Failure to follow these instructions may result in fire or death.
- **If connecting to existing ductwork, make sure it is suitable and clean before installing the dryer.** Failure to follow these instructions may result in fire or death.
- **Venting must conform to local building codes.** Failure to follow these instructions may result in fire or death.
- **Gas dryers MUST exhaust to the outdoors.** Failure to follow these instructions may result in fire or death.
- **Use only 4-inch (10.2 cm) rigid, semi-rigid or flexible metal ductwork inside the dryer cabinet and for venting outside.** Failure to follow these instructions may result in fire or death.
- **To reduce the risk of fire, combustion, or accumulation of combustible gases, DO NOT exhaust dryer air into an enclosed and unventilated area, such as an attic, wall, ceiling, crawl space, chimney, gas vent, or concealed space of a building.** Failure to follow these instructions may result in fire or death.
- **To reduce the risk of fire, DO NOT exhaust the dryer with plastic or thin foil ducting.** Failure to follow these instructions may result in fire or death.
- **The exhaust duct must be 4-inch (10.2 cm) in diameter with no obstructions. The exhaust duct should be kept as short as possible. Make sure to clean any old ducts before installing your new dryer.** Failure to follow these instructions may result in fire or death.
- **Rigid, semi-rigid or flexible metal ducting is recommended for use between the dryer and the wall. All non-rigid metal transition duct must be UL-listed. Use of other materials for transition duct could affect drying time.** Failure to follow these instructions may result in fire or death.

- **DO NOT use sheet metal screws or other fasteners which extend into the duct that could catch lint and reduce the efficiency of the exhaust system. Secure all joints with duct tape.** Failure to follow these instructions may result in fire or death.
- **Do not exceed the recommended duct length limitations noted in the chart.** Failure to follow these instructions may result in extended drying times, fire or death.
- **Ductwork is not provided with the dryer. You should obtain the necessary ductwork locally. The vent hood should have hinged dampers to prevent backdraft when the dryer is not in use.** Failure to follow these instructions may result in fire or death.
- **The total length of flexible metal duct must not exceed 8 ft. (2.4 m).**
- **In Canada, only those foil-type flexible ducts, if any, specifically identified for use with the appliance by the manufacturer should be used.** In the United States, only those foil-type flexible ducts, if any, specifically identified for use with the appliance by the manufacturer and that comply with the Outline for Clothes Dryer Transition Duct, Subject 2158A, should be used.

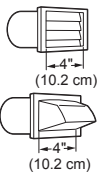
### Ductwork

Wall Cap Type	Number of 90° Elbows	Maximum length of 4-inch (10.2 cm) diameter rigid metal duct
	0	65 ft.(19.8 m)
	1	55 ft.(16.8 m)
	2	47 ft.(14.3 m)
	3	36 ft.(11.0 m)
	4	28 ft.(8.5 m)
Use only for short run installations 	0	55 ft.(16.8 m)
	1	47 ft.(14.3 m)
	2	41 ft.(12.5 m)
	3	30 ft.(9.1 m)
	4	22 ft.(6.7 m)

#### NOTE

Deduct 6 ft. (1.8 m) for each additional elbow. Do not use more than four 90° elbows.

## Routing And Connecting Ductwork

### NOTE

Follow the guidelines below to maximize drying performance and reduce lint buildup and condensation in the ductwork. Ductwork and fittings are NOT included and must be purchased separately.

- Use 4-inch (10.2 cm) diameter rigid, semi-rigid or flexible metal ductwork.
- The exhaust duct run should be as short as possible.
- Use as few elbow joints as possible.
- The male end of each section of exhaust duct must point away from the dryer.
- Use duct tape on all duct joints.
- Insulate ductwork that runs through unheated areas in order to reduce condensation and lint buildup on duct surfaces.
- Incorrect or inadequate exhaust systems are not covered by the dryer warranty. Dryer failures or service required because of such exhaust systems will not be covered by the dryer warranty.

### Correct Venting

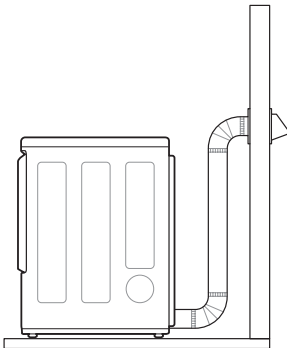

### Incorrect Venting

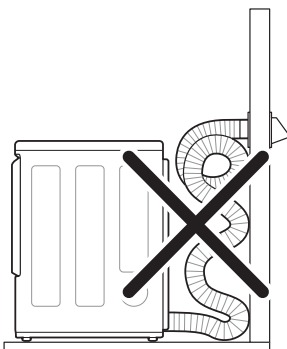

## Connecting the Inlet Hose (Steam Models)

The dryer must be connected to the cold water tap using a new water supply hose. Do not use old hoses.

### NOTE

- Water supply pressure must be between 20 and 120 psi (138—827 kPa).
- Do not strip or cross-thread when connecting the inlet hose to the valve.
- If the water supply pressure is more than 800 kPa, a pressure-reducing valve should be installed.
- Periodically check the condition of the hose and replace the hose if necessary.
- Replace inlet hoses after 5 years of use to reduce the risk of hose failure.
- Record hose installation or replacement dates on the hoses for future reference.

- 1 Check the rubber seal at each end of the inlet hoses. Two rubber seals are supplied with each inlet hose. They are used for preventing water leaks. Make sure the connection to the cold water tap is tight.

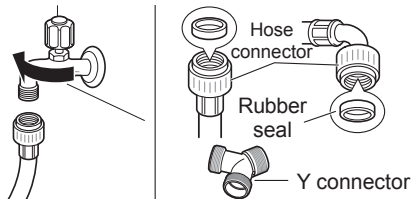

- 2 Check the installation type.

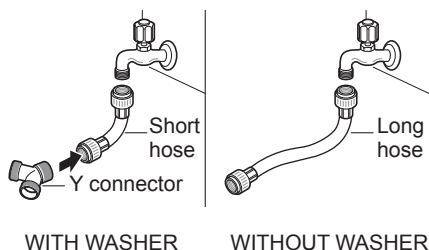

**Connect all water supply hoses tightly by hand and then tighten another 2/3 turn with pliers.**

**WITH WASHER: When connecting the dryer to the same faucet as a washer.**

- a. Shut off the cold water tap and remove the washer hose.
- b. Connect the short hose to the Y-connector using one of the rubber seals.
- c. Connect the other end of the short hose to the cold water faucet.

- d. Connect the long dryer hose to one side of the Y-connector and connect the washer hose to the other side.

**WITHOUT WASHER: If the dryer does not share the cold water tap with a washer.**

- a. Connect the straight end of the long hose to the cold water faucet.

### NOTE

- Before connecting the water line to the dryer, flush several gallons of water into a drain or bucket. This will help prevent foreign particles such as sand and scale from clogging the dryer inlet valve.
- Do not overtighten. Damage to the coupling may result.

- 3 Connect the hose to the dryer. Connect the water supply hose to the dryer inlet valve tightly by hand and then tighten another 2/3 turn with pliers. Make sure that there are no kinks in the hoses and that they are not crushed.

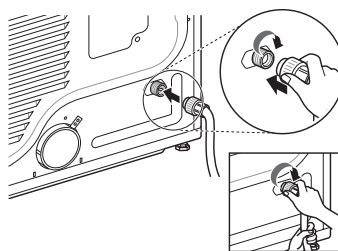

- 4 Turn on the cold water faucet.

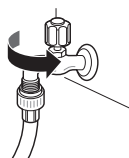

- 5 Check for leaks at the Y-connector (if used) and in all hoses.

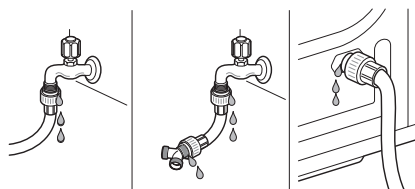

### NOTE

- If any leaks are found, shut off the water faucet, remove the hose and check the condition of the rubber seal.

## Connecting Gas Dryers



### WARNING

To reduce the risk of fire or explosion, electric shock, property damage, injury to persons, or death when using this appliance, follow basic safety precautions.

### Gas Supply Requirements

- **As shipped from the factory, this dryer is configured for use with natural gas (NG). It can be converted for use with propane (LP) gas. Gas pressure must not exceed 8-inch (20.3 cm) water column for NG, or 13-inch (33 cm) water column for LP.**
- **A qualified service or gas company technician must connect the dryer to the gas service. Failure to follow these instructions may result in fire, explosion, or death.**
- **Isolate the dryer from the gas supply system by closing its individual manual shutoff valve during any pressure testing of the gas supply. Failure to do so may result in fire, explosion, or death.**
- **Supply line requirements: Your laundry room must have a rigid gas supply line to your dryer. In the United States, an individual manual shutoff valve MUST be installed within at least 6 ft. (1.8 m) of the dryer, in accordance with the National Fuel Gas Code ANSI Z223.1 or Canadian gas installation code CSA B149.1. A 1/8-inch (0.3 cm) NPT pipe plug must be installed. Failure to do so may result in fire, explosion, or death.**
- **If using a rigid pipe, the rigid pipe should be 1/2 inch IPS. If acceptable under local codes and ordinances and when acceptable to your gas supplier, 3/8-inch (1 cm) approved tubing may be used where lengths are less than 20 ft. (6.1 m). Larger tubing should be used for lengths in excess of 20 ft. (6.1 m). Failure to do so may result in fire, explosion, or death.**
- **Connect the dryer to the type of gas shown on the nameplate. Failure to do so may result in fire, explosion, or death.**
- **To prevent contamination of the gas valve, purge the gas supply of air and sediment before connecting the gas supply to the dryer. Before tightening the connection between the gas supply and the dryer, purge remaining air until the odor of gas is detected. Failure to do so may result in fire, explosion, or death.**

- **DO NOT use an open flame to inspect for gas leaks. Use a noncorrosive leak detection fluid.** Failure to do so may result in fire, explosion, or death.
- **Use only a new AGA- or CSA-certified gas supply line with flexible stainless steel connectors.** Failure to do so may result in fire, explosion, or death.
- **Securely tighten all gas connections.** Failure to do so may result in fire, explosion, or death.
- **Use Teflon tape or a pipe-joint compound that is insoluble in propane (LP) gas on all pipe threads.** Failure to do so may result in fire, explosion, or death.
- **DO NOT attempt any disassembly of the dryer; disassembly requires the attention and tools of an authorized and qualified service technician or company.** Failure to follow this warning may result in fire, explosion, or death.

### Electrical Requirements for Gas Models Only

- **Do not, under any circumstances, cut or remove the third (ground) prong from the power cord.** Failure to follow this warning may result in fire, explosion, or death.
- **For personal safety, this dryer must be properly grounded.** Failure to follow this warning may result in fire, explosion, or death.
- **The power cord of this dryer is equipped with a 3-prong (grounding) plug which mates only with a standard 3-prong (grounding) wall outlet to minimize the possibility of electric shock hazard from this appliance.** Failure to follow this warning may result in fire, explosion, or death.
- **This dryer must be plugged into a 120-VAC, 60-Hz. grounded outlet protected by a 15-ampere fuse or circuit breaker.** Failure to follow this warning may result in fire, explosion, or death.
- **Where a standard 2-prong wall outlet is encountered, it is your personal responsibility and obligation to have it replaced with a properly grounded 3-prong wall outlet.** Failure to follow this warning may result in fire, explosion, or death.



Plug dryer into a 120 VAC, 60 Hz grounded 3-prong outlet.

## Connecting the Gas Supply

- **Installation and service must be performed by a qualified installer, service agency, or the gas supplier.** Failure to do so may result in fire, explosion, or death.
- **Use only a new stainless steel flexible connector and a new AGA-certified connector.** Failure to do so may result in fire, explosion, or death.
- **A gas shutoff valve must be installed within 6 ft. (1.8 m) of the dryer.** Failure to do so may result in fire, explosion, or death.
- **The dryer is configured for natural gas when shipped from the factory. Make sure that the dryer is equipped with the correct burner nozzle for the type of gas being used (natural gas or propane gas).** Failure to do so may result in fire, explosion, or death.
- **If necessary, the correct nozzle (for the LP nozzle kit, order part number 383EEL3002D) should be installed by a qualified technician and the change should be noted on the dryer.** Failure to do so may result in fire, explosion, or death.
- **All connections must be in accordance with local codes and regulations.** Failure to do so may result in fire, explosion, or death.
- **Gas dryers MUST exhaust to the outdoors.** Failure to do so may result in fire, explosion, or death.

### NOTE

This dryer is configured from the factory for natural gas (NG). If the dryer is to be used with propane (LP) gas, it must be converted by a qualified service technician.

- 1** Make sure that the gas supply to the laundry room is turned OFF and the dryer is unplugged. Confirm that the type of gas available in your laundry room is appropriate for the dryer.
- 2** Remove the shipping cap from the gas fitting at the back of the dryer. Be careful not to damage the threads of the gas connector when removing the shipping cap.
- 3** Connect the dryer to your laundry room's gas supply using a new flexible stainless steel connector with a 3/8-inch NPT fitting.

### NOTE

DO NOT use old connectors.

- 4** Securely tighten all connections between the dryer and your laundry room's gas supply.
- 5** Turn on your laundry room's gas supply.
- 6** Check all pipe connections (both internal and external) for gas leaks with a noncorrosive leak-detection fluid.
- 7** Proceed to Venting the Dryer.

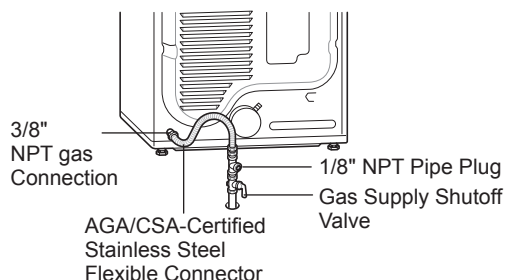

## High-altitude Installations

The BTU rating of this dryer is AGA-certified for elevations below 10,000 feet.

If your gas dryer is being installed at an elevation above 10,000 feet, it must be derated by a qualified technician or gas supplier.



## Connecting Electric Dryers

### Electrical Requirements for Electric Models Only

#### WARNING

To help prevent fire, electric shock, serious injury, or death, the wiring and grounding must conform to the latest edition of the National Electrical Code, ANSI/NFPA 70 and all applicable local regulations. Please contact a qualified electrician to check your home's wiring and fuses to ensure that your home has adequate electrical power to operate the dryer.

- **This dryer must be connected to a grounded metal, permanent wiring system, or an equipment-grounding conductor must be run with the circuit conductors and connected to the equipment-grounding terminal or lead on the dryer.** Failure to do so may result in fire, explosion, or death.
  - **The dryer has its own terminal block that must be connected to a separate 240 VAC, 60-Hertz, single-phase circuit, fused at 30 amperes (the circuit must be fused on both sides of the line). ELECTRICAL SERVICE FOR THE DRYER SHOULD BE OF THE MAXIMUM RATE VOLTAGE LISTED ON THE NAMEPLATE. DO NOT CONNECT THE DRYER TO 110-, 115-, OR 120-VOLT CIRCUIT.** Failure to follow these instructions may result in fire, explosion, or death.
  - **If the branch circuit to dryer is 15 ft. (4.5 m) or less in length, use UL (Underwriters Laboratories) listed No.-10 AWG wire (copper wire only), or as required by local codes. If over 15 ft. (4.5 m), use UL-listed No.-8 AWG wire (copper wire only), or as required by local codes. Allow sufficient slack in wiring so the dryer can be moved from its normal location when necessary.** Failure to do so may result in fire, explosion, or death.
  - **The power cord (pigtail) connection between the wall receptacle and the dryer terminal block IS NOT supplied with the dryer. Type of pigtail and gauge of wire must conform to local codes and with instructions on the following pages.** Failure to follow these instructions may result in fire, explosion, or death.
  - **A 4-wire connection is required for all mobile and manufactured home installations, as well as all new construction after January 1, 1996. A 4-wire connection must be used where local codes do not permit grounding through the neutral wire.** Failure to do so may result in fire, explosion, or death.
  - Do not modify the plug and internal wire provided with the dryer.
  - The dryer should be connected to a 4-hole outlet.
  - If the plug does not fit the outlet, a proper outlet will need to be installed by a qualified electrician.
- Any installation in a manufactured or mobile home must comply with the Manufactured Home Construction and Safety Standards Title 24 CFR, Part 3280 or Standard CAN/ CSA Z240 MH and local codes and ordinances. If you are uncertain whether your proposed installation will comply with these standards, please contact a service and installation professional for assistance.
  - **A 4-wire connection is required for all mobile and manufactured home installations, as well as all new construction after January 1, 1996.** Failure to do so may result in fire, explosion, or death.
  - A gas dryer must be permanently attached to the floor.
  - The electrical connection for an electric dryer must be a 4-wire connection. More detailed information concerning the electrical connection is provided in the section Connecting Electric Dryers.
  - To reduce the risk of combustion and fire, the dryer must be vented to the outside.
  - DO NOT vent the dryer under a manufactured home or mobile home.
  - Electric dryers may be vented to the outside using the back, left, right, or bottom panel.
  - Gas dryers may be vented to the outside using the back, left, or bottom panel. Gas dryers may not be vented to the outside using the right side panel because of the burner housing.
  - The dryer exhaust duct must be affixed securely to the manufactured or mobile home structure, and the exhaust duct must be made of a material that will resist fire and combustion. It is recommended that you use a rigid, semi-rigid or flexible metal duct.
  - DO NOT connect the dryer exhaust duct to any other duct, vent, chimney, or other exhaust duct.
  - Make sure the dryer has adequate access to outside fresh air to ensure proper operation. The opening for outside fresh air must be at least 25 sq. in (163 cm<sup>2</sup>).
  - It is important that the clearance of the duct from any combustible construction be at least 2-inch (5 cm), and when venting the dryer to the outdoors, the dryer should be installed with a clearance of at least 1 inch (2.5 cm) at the sides and back of the dryer.
  - Please be aware that venting materials are not supplied with the dryer. You must obtain the venting materials necessary for proper installation.

## ⚠ WARNING

Connect the power cord to the terminal block. Each colored wire should be connected to the same color screw. Wire color indicated on manual is connected to the same color screw in the block. Failure to follow these instructions may result in a short or overload.

Grounding through the neutral conductor is prohibited for: (1) new branch-circuit installations, (2) mobile homes, (3) recreational vehicles, and (4) areas where local codes prohibit grounding through the neutral conductor.

## Four-Wire Power Cord

- A 4-wire connection is required for all mobile and manufactured home installations, as well as all new construction after January 1, 1996.
- A UL-listed strain relief is required.
- Use a 30-amp, 240-volt, 4-wire, UL-listed power cord with #10 AWG-minimum copper conductor and closed loop or forked terminals with upturned ends.

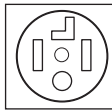

- 1 Remove the terminal block access cover on the upper back of the dryer.
- 2 Install a UL-listed strain relief into the power cord through-hole.
- 3 Thread a 30-amp, 240-volt, 4-wire, UL-listed power cord with #10 AWG-minimum copper conductor through the strain relief.

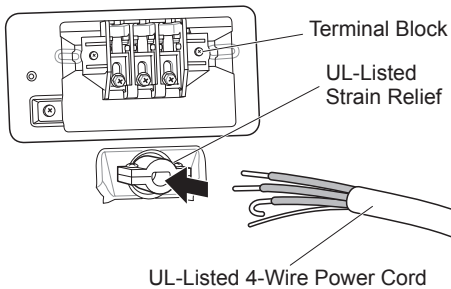

- 4 Transfer the dryer's ground wire from behind the green ground screw to the center screw of the terminal block.

## NOTE

This dryer is supplied with the neutral wire grounded. This white ground wire **MUST BE MOVED** to the neutral terminal when a 4-wire cord is to be used, or where grounding through the neutral conductor is prohibited.

- 5 Attach the two hot leads of the power cord to the outer terminal block screws.
- 6 Attach the white neutral wire to the center screw of the terminal block.
- 7 Attach the power cord ground wire to the green ground screw.
- 8 Tighten all screws securely.
- 9 Reinstall the terminal block access cover.

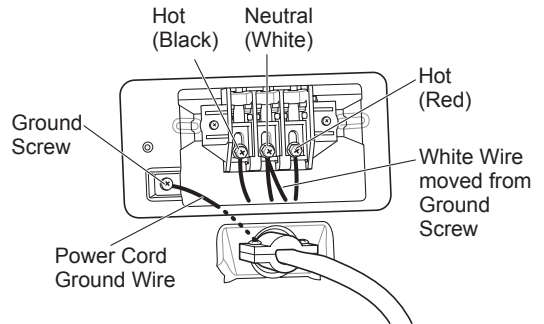



### Four-Wire Direct Wire

- A 4-wire connection is required for all mobile and manufactured home installations, as well as all new construction after January 1, 1996.
- A UL-listed strain relief is required.
- Use UL-listed 4-wire #10 AWG-minimum copper conductor cable. Allow at least 5 ft. (1.5 m) of wire to allow for removal and reinstallation of the dryer.

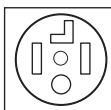

- 1 Remove 5-inch (12.7 cm) of the outer covering from the wire. Remove 5-inch (12.7 cm) of insulation from the ground wire. Cut off approximately 1½-inch (3.8 cm) from the other three wires and strip 1 inch (2.5 cm) insulation from each wire. Bend the ends of the three shorter wires into a hook shape.

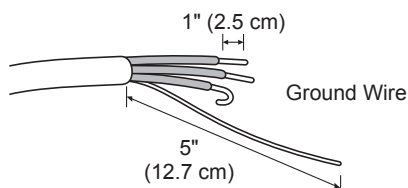

- 2 Remove the terminal block access cover on the upper back of the dryer.
- 3 Install a UL-listed strain relief into the power cord through-hole.
- 4 Thread the 4-wire #10 AWG-minimum copper power cable prepared in step 1 through the strain relief.

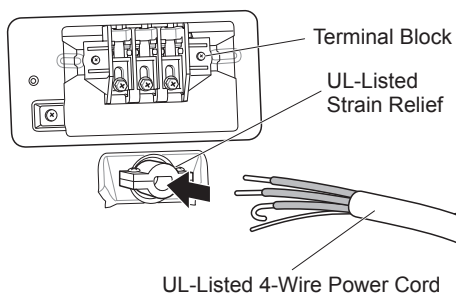

- 5 Transfer the dryer's ground wire from behind the green ground screw to the center screw of the terminal block.

**NOTE**

This dryer is supplied with the neutral wire grounded. This white ground wire **MUST BE MOVED** to the neutral terminal when a 4-wire cord is to be used, or where grounding through the neutral conductor is prohibited.

- 6 Attach the two hot leads of the power cord to the outer terminal block screws.
- 7 Attach the white neutral wire to the center screw of the terminal block.
- 8 Attach the power cord ground wire to the green ground screw.
- 9 Tighten all screws securely.
- 10 Reinstall the terminal block access cover.

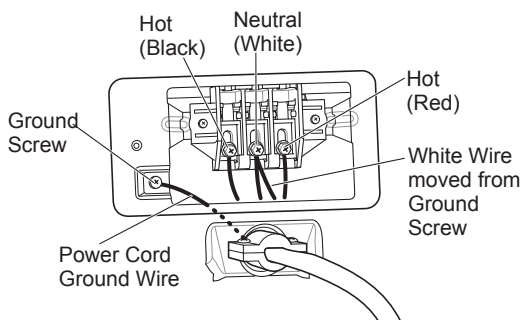

## Three-Wire Power Cord

- A 3-wire connection is NOT permitted on new construction after January 1, 1996.
- A UL-listed strain relief is required.
- Use a 30-amp, 240-volt, 3-wire, UL-listed power cord with #10 AWG-minimum copper conductor and closed loop or forked terminals with upturned ends.



- 1 Remove the terminal block access cover on the upper back of the dryer.
- 2 Install a UL-listed strain relief into the power cord through-hole.
- 3 Thread a 30-amp, 240-volt, 3-wire, UL-listed power cord with #10 AWG-minimum copper conductor through the strain relief.

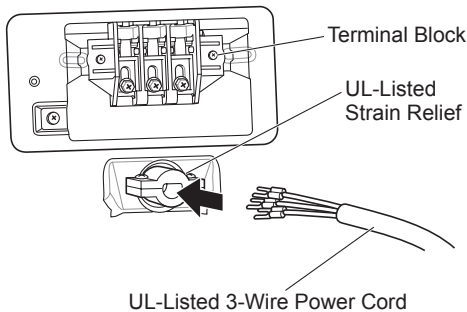

- 4 Attach the two hot leads (black and red) of the power cord to the outer terminal block screws.
- 5 Attach the neutral (white) wire to the center terminal block screw.

### NOTE

The dryer is supplied with the neutral conductor grounded. If a 3-wire cord is to be used and is allowed, make sure the white neutral grounding wire is connected to the green ground screw.

- 6 Connect the external ground (if required by local codes) to the green ground screw.
- 7 Tighten all screws securely.

- 8 Reinstall the terminal block access cover.

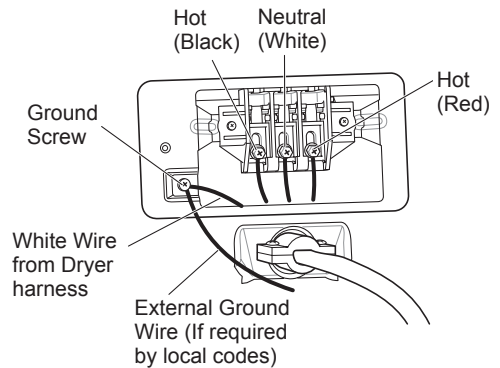

## Three-Wire Direct Wire

- A 3-wire connection is NOT permitted on new construction after January 1, 1996.



- A UL-listed strain relief is required.
- Use UL-listed 3-wire, #10 AWG-minimum copper conductor cable. Allow at least 5 ft. (1.5 m) length to allow for removal and installation of dryer.

- 1 Remove 3½-inch (8.9 cm) of the outer covering from the wire. Strip 1 inch (2.5 cm) insulation from each wire. Bend the ends of the three wires into a hook shape.

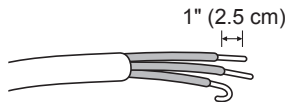

- 2 Remove the terminal block access cover on the upper back of the dryer.
- 3 Install a UL-listed strain relief into the power cord through-hole.
- 4 Thread the 3-wire, #10 AWG-minimum copper conductor power cable prepared in step 1 through the strain relief.

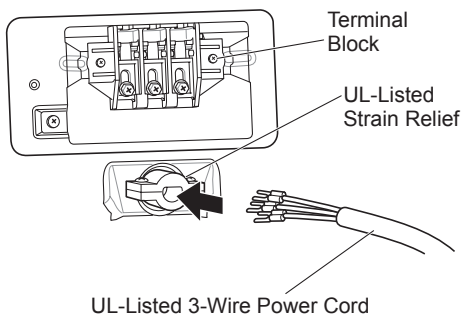

- 5 Attach the two hot leads (black and red) of the power cord to the outer terminal block screws.
- 6 Attach the neutral (white) wire to the center terminal block screw.

### NOTE

The dryer is supplied with the neutral conductor grounded. If a 3-wire cord is to be used and is allowed, make sure the white neutral grounding wire is connected to the green ground screw.

- 7 Connect the external ground (if required by local codes) to the green ground screw.
- 8 Tighten all screws securely.

- 9 Reinstall the terminal block access cover.

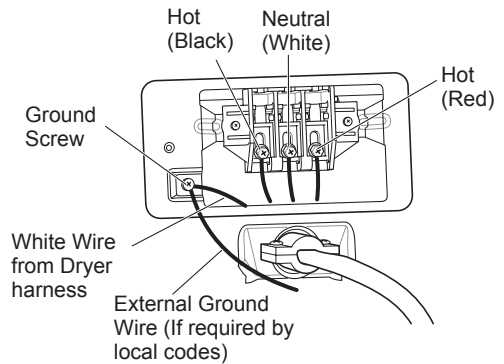

## Final Installation Check

Once you have completed the installation of the dryer and it is in its final location, confirm proper operation with the following tests and Installation Test (Duct Check) on the following page.

## Testing Dryer Heating

### GAS MODELS

Close the dryer door, press the **POWER** button to turn the dryer on, and start the dryer on a heat setting. When the dryer starts, the igniter should ignite the main burner.

### ELECTRIC MODELS

Close the dryer door, press the **POWER** button to turn the dryer on, and start the dryer on a heat setting. The exhaust air should be warm after the dryer has been operating for 3 minutes.

## Checking Airflow

Effective dryer operation requires proper airflow. The adequacy of the airflow can be measured by evaluating the static pressure. Static pressure in the exhaust duct can be measured with a manometer, placed on the exhaust duct approximately 2 ft. (60.9 cm) from the dryer. Static pressure in the exhaust duct should not exceed 0.6-inch (1.5 cm). The dryer should be checked while the dryer is running with no load.

## Checking Levelness

Once the dryer is in its final location, recheck the dryer to be sure it is level. Make sure it is level front to back and side to side, and that all four leveling feet are firmly on the floor.

## Installation Test (Duct Check)

Once you have completed the installation of the dryer, use this test to make sure the condition of the exhaust system is adequate for proper operation of the dryer. This test should be performed to alert you to any serious problems in the exhaust system of your home.

- Your dryer features Flow Sense™, an innovative sensing system that automatically detects blockages and restrictions in dryer ductwork. Keeping ductwork clean of lint buildup and free of restrictions allows clothes to dry faster and reduces energy use.

### NOTE

The dryer should be cool before starting this test. If the dryer was warmed up during installation, run the AIR DRY cycle for a few minutes to reduce the interior temperature.

To activate the installation test:

### 1 Remove the drying rack and literature, and then close the door.

Do not load anything in the drum for this test, as it may affect the accuracy of the results.

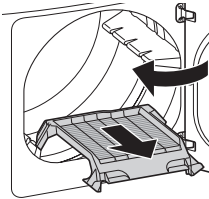

### 2 Press the Power button then immediately press and hold both the Temp. and Signal buttons until **InS** appears in the display.



### 3 Press the START/PAUSE button.

The dryer will start the test, which will last about 2 minutes. The heat will be turned on and the temperatures in the drum will be measured.



### 4 Check the display for results.

During the test cycle, monitor the Flow Sense™ display on the control panel. If no bars are displayed, when the cycle ends, the exhaust system is adequate. If the exhaust system is severely restricted, the display will show four bars. Other problems may also be shown with error codes. Refer to the next page for error code details and solutions.



Flow Sense

NO BARS:  
OK



Flow Sense

FOUR BARS:  
RESTRICTED

Four bars indicates that the exhaust system is severely restricted. Have the system checked immediately, as performance will be poor.

### 5 End of cycle.

At the end of the test cycle, **End** will display. The test cycle will end and the dryer will shut off automatically after a short delay.



### • Check the error code before you call for service

Error Code	Possible Causes	Solutions
tE1 or tE2	<ul style="list-style-type: none"> <li>Temperature sensor failure.</li> </ul>	<ul style="list-style-type: none"> <li>Turn off the dryer and call for service.</li> </ul>
HS	<ul style="list-style-type: none"> <li>Humidity sensor failure.</li> </ul>	<ul style="list-style-type: none"> <li>Turn off the dryer and call for service.</li> </ul>
PS or PF or nP	<ul style="list-style-type: none"> <li>Electric dryer power cord is not connected correctly, or house power supply is incorrect.</li> <li>House fuse is blown, circuit breaker has tripped, or power outage has occurred.</li> </ul>	<ul style="list-style-type: none"> <li>Check the power supply or the connection of the power cord to the terminal block. Refer to the <b>Connecting Electric Dryers</b> section of this manual for complete instructions.</li> <li>Reset circuit breaker or replace fuse. Do not increase the fuse capacity. If the problem is a circuit overload, have it corrected by a qualified electrician.</li> </ul>

• **Check the duct condition**

If the Flow Sense™ LED is turned on, check the exhaust system for restrictions and damage. Repair or replace the exhaust system as needed.

**NOTE**

When the dryer is first installed, this test should be performed to alert you to any existing problems with the exhaust duct in your home. However, since the test performed during normal operation provides more accurate information on the condition of the exhaust duct than does the installation test, the number of bars displayed during the two tests may not be the same.

Do not interrupt the test cycle, as this could result in inaccurate results.

Even if no bars are displayed during the test cycle, some restrictions may still be present in the exhaust system. Refer to the **Venting the Dryer** section of this manual for complete exhaust system and venting requirements.

Your dryer features Flow Sense™, an innovative sensing system that automatically detects blockages and restrictions in the dryer ductwork. Keeping ductwork clean of lint buildup and free of restrictions allows clothes to dry faster and reduces energy use.

**Restricted or Blocked Airflow**

Avoid long runs or runs with multiple elbows or bends.

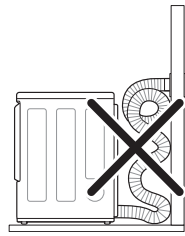

Excess or crushed transition duct

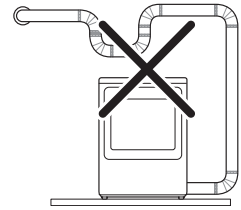

Too many elbows or exhaust too long

Check for blockages and lint buildup.

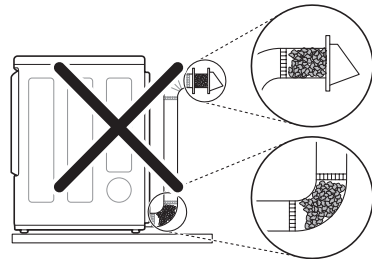

Lint buildup or blockage

Make sure the ductwork is not crushed or restricted.

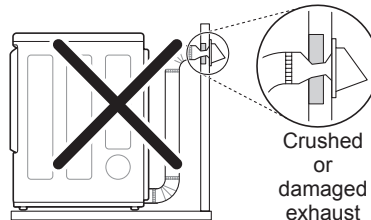

Crushed or damaged exhaust

# OPERATION

## ⚠ WARNING

To reduce the risk of fire, electric shock, or injury to persons, read this entire manual, including the **IMPORTANT SAFETY INSTRUCTIONS**, before operating this dryer.

## Using the Dryer

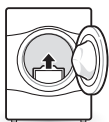

### 1 Clean the Lint Filter

If the lint filter has not already been cleaned, lift out the filter and remove the lint from the last load. This will help ensure the fastest and most efficient drying performance. Make sure to reinstall the filter, pressing down until it clicks firmly into place. The dryer will not operate without the lint filter in place.

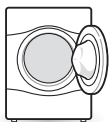

### 2 Load the Dryer

Load the dryer with the wet laundry from the washer. If the load is extra large, you may need to divide it into smaller loads for proper performance and fabric care.



### 3 Turn on The Dryer

Press the **POWER** button to turn ON the dryer. The cycle LEDs will illuminate and a chime will sound.

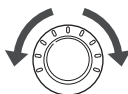

### 4 Select a Cycle

Turn the cycle selector knob either direction until the LED for the desired cycle is on. The preset temperature, dry level, and option settings for that cycle will be shown. Refer to page 37. Default settings for the selected cycle can now be changed if desired. This can be done using the cycle modifier buttons as shown on page 37. Cycle options can be added using the option buttons as shown on page 38-41.

#### NOTE

Not all options or modifiers are available on all cycles. A different chime will sound and the LED will not come on if the selection is not allowed.



### 5 Begin the Cycle

Press the **START/PAUSE** button to begin the cycle. The cycle can be paused at any time either by opening the door or by pressing the **START/PAUSE** button. If the cycle is not restarted within 4 minutes of being paused, the dryer will shut off and the settings will be lost.



### 6 End of Cycle

When the cycle is finished, the chime will sound. Immediately remove your clothing from the dryer to reduce wrinkling. If **Wrinkle Care** is selected, the dryer will tumble briefly every few minutes to help prevent wrinkles from setting in the clothes.

## Check the Lint Filter Before Every Load

Always make sure the lint filter is clean before starting a new load; a clogged lint filter will increase drying time. To clean, pull the lint filter straight up and roll any lint off the filter with your fingers. Do not rinse or wash the filter to remove lint. Push the lint filter firmly back into place. See **Regular Cleaning** for more information.

Always ensure the lint filter is properly installed before running the dryer. Running the dryer with a loose or missing lint filter will damage the dryer and articles in the dryer.

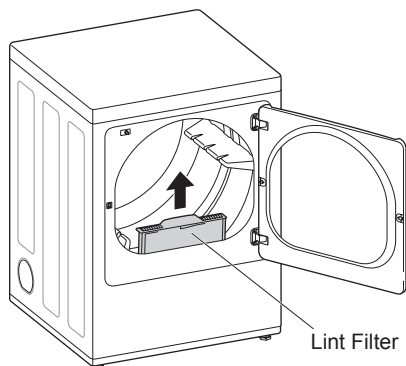

## Sorting Loads

### Fabric Care Labels

Most articles of clothing feature fabric care labels that include instructions for proper care.

**Fabric Care Labels**

**Tumble dry**

Dry	Normal	Permanent Press/ wrinkle resistant
Gentle/ delicate	Do not tumble dry	Do not dry (used with do not wash)

**Heat setting**

High	Medium	Low	No heat/air

## Group Similar Items

For best results, sort clothes into loads that can be dried with the same drying cycle.

Different fabrics have different care requirements, and some fabrics will dry more quickly than others. For best fabric care results, always dry fabrics with similar care requirements together.

## Loading the Dryer

### WARNING

To reduce the risk of fire, electric shock, or injury to persons when using this appliance, follow basic precautions, including the following:

- Check all pockets to make sure that they are empty. Items such as clips, pens, coins, and keys can damage both your dryer and your clothes. Flammable objects such as lighters or matches could ignite, causing a fire. Failure to do so may result in fire, explosion, or death.
- Never dry clothes that have been exposed to oil, gasoline, or other flammable substances. Washing clothes will not completely remove oil residues. Failure to obey this warning may result in fire, explosion, or death.

### NOTE

#### Loading Tips

- Combine large and small items in the same load.
- Damp clothes will expand as they dry. Do not overload the dryer; clothes require room to tumble and dry properly.
- Close zippers, hooks, and drawstrings to prevent these items from snagging or tangling on other clothes.

## Using the LG EasyLoad™

### Swing Door

Use the swing door when unloading, or when loading bulkier items, for easy access to the drum.

To open the swing door, grasp the top of the door on the side opposite the hinge and pull.

#### NOTE

Make sure the hamper door release is completely closed before using the swing door.

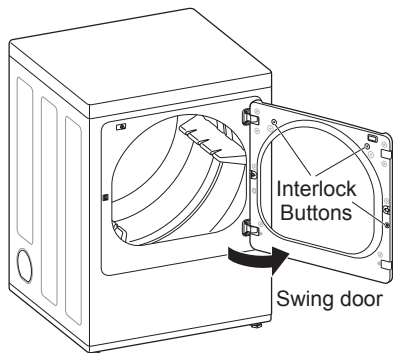

#### ⚠ WARNING

Do not press the three interlock buttons when the door is open. The door may fall off and cause serious injury.

- **Do not place heavy items on or lean against the top of the door when it is open.**

The dryer could tip forward, causing injury or property damage.

### Hamper Door (on some models)

Use the hamper door when loading. The hamper door opens about 40 degrees and acts as a chute to help guide items into the drum and help prevent items from falling onto the floor. It also comes in handy when unloading a few small items, helping prevent the rest of the laundry from being pulled onto the floor.

To open the hamper door, press the release on the top of the door and pull the door forward.

Make sure laundry is fully inserted in the drum before closing the door.

#### NOTE

Make sure the swing door latch is completely closed before pressing the hamper door release.

Hamper door release

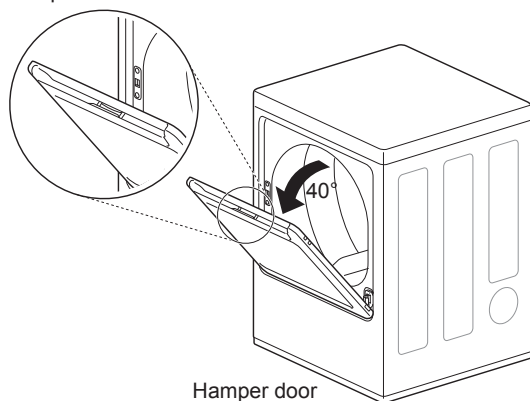

#### ⚠ WARNING

- Do not attempt to pull the hamper door open more than 40 degrees.
- Be careful when opening and closing the door. Fingers and hands can get caught in the door and cause injury if the door drops forward unexpectedly.



## Control Panel

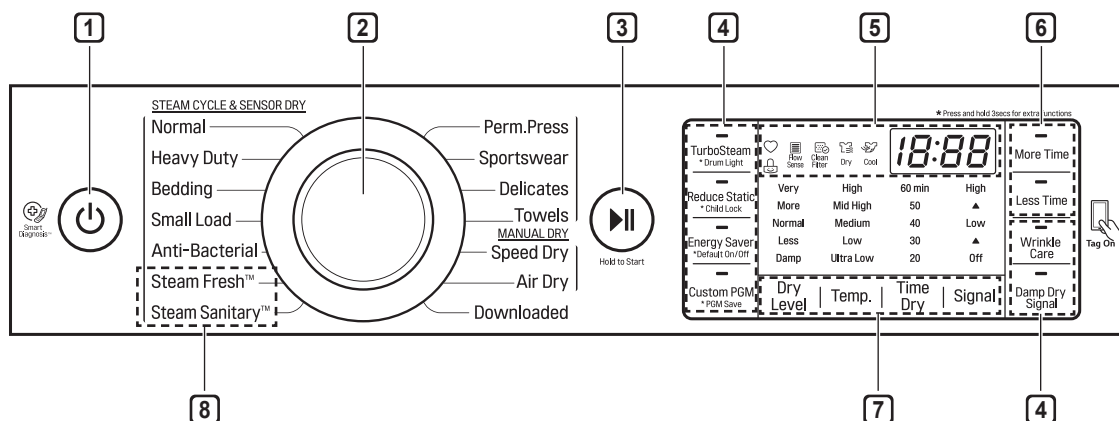

### NOTE

Model numbers can be found on the cabinet inside the door.

### 1 POWER Button

Press to turn the dryer ON. Press again to turn the dryer OFF.

### NOTE

Pressing the **POWER** button during a cycle will cancel that cycle and any load settings will be lost.

### 2 Cycle Selector Knob

Turn this knob to select the desired cycle. Once the desired cycle has been selected, the standard presets are shown in the display. On Manual Dry cycles, these settings can be adjusted using the cycle modifier buttons any time before starting the cycle.

### 3 START/PAUSE Button

Press this button to start the selected cycle. If the dryer is running, use this button to pause the cycle without losing the current settings.

### NOTE

If you do not press the **START/PAUSE** button to resume a cycle within 4 minutes, the dryer turns off automatically.

### 4 Cycle option Buttons

The option buttons allow you to select additional cycle options. Certain buttons also allow you to activate special functions by pressing and holding the button for 3 seconds.

### 5 Time and Status Display

The display shows the settings, estimated time remaining, options, and status messages for your dryer.

### 6 MORE TIME/LESS TIME Buttons

Use these buttons with the Time Dry and other MANUAL DRY cycles to adjust the drying time. Press the **More Time** button to increase the selected manual cycle time by 1 minute; press the **Less Time** button to decrease the cycle time by 1 minute.

### 7 Cycle Modifier Buttons

Use these buttons to select the desired cycle settings for the selected cycle. The current settings are shown in the display. Press the button for that option to select other settings.

### 8 Steam Functions

LG's steam technology allows you to inject fabrics with a swirling jet of steam to refresh clothes, reduce static, and make ironing easier. Simply select the Steam Fresh™ cycle or Wrinkle Free cycle.

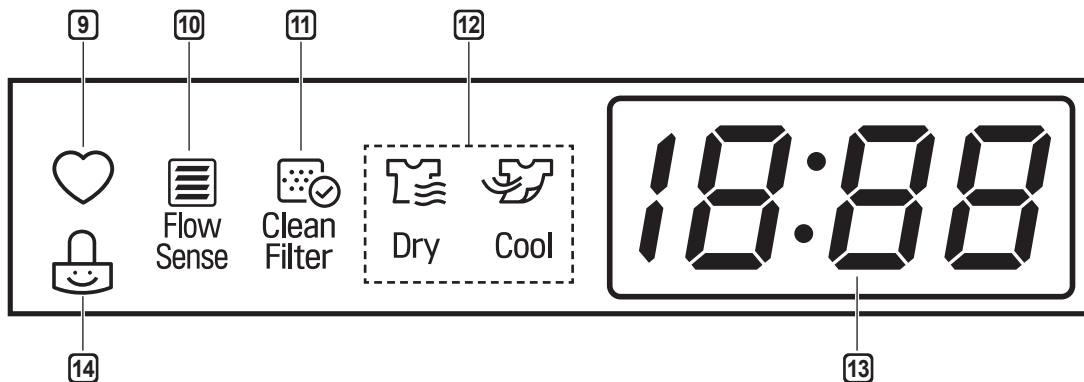

### 9 Custom PGM

If you have a special combination of settings that you use frequently, you can save these settings as a Custom Program.

### 10 Flow Sense™ Duct Blockage Sensing System Indicator

The Flow Sense™ duct blockage sensing system detects and alerts you to blockages in the ductwork that reduce exhaust flow from the dryer. Maintaining a clean exhaust system improves operating efficiency and helps minimize service calls, saving you money.

### 11 Clean Filter Reminder

The display will show Clean Filter when the dryer is turned on as a reminder to check the filter. It turns off when the **START/PAUSE** button is pressed.

### 12 Cycle Completion Indicator with Check Filter Reminder

This portion of the display shows which stage of the drying cycle is currently underway (Clean Filter, Dry, Cool).

### 13 Estimated Time Remaining

This display shows the estimated time remaining for SENSOR DRY cycles or the actual time remaining for Time Dry or MANUAL DRY cycles.

#### NOTE

The cycle time on SENSOR DRY cycles may fluctuate as the dryer recalculates drying time for optimal results.

### 14 Child Lock Indicator

When Child Lock is set, the Child Lock indicator will appear and all buttons will be disabled except the **POWER** button. This prevents children from changing settings while the dryer is operating.

# Cycle Guide

■ = default setting  
○ = allowable option

Cycle	Fabric Type	Dry Level	Temperature	Time	More Time/ Less Time	Wrinkle Care	Turbo Steam	Damp Dry Signal	Reduce Static	Energy Saver
Steam Fresh™	Comforter, Shirts, Trousers (except especially delicate fabrics)	Off	Mid High	10	○	○	■			
			Adjustable	Adjustable						
Steam Sanitary™	Comforter, Bedding, Children's clothing	Off	High	31		○	■			
Anti-Bacterial	Do not use this cycle with delicate fabrics.	Very Dry	High	1:10		○				
Small Load	Only Normal & Cotton/Towels Fabric Type (Max 3 lb)	Normal Dry	High	30		○				
		Adjustable								
Bedding	Comforters, Pillows, Shirts	Normal Dry	Medium	55					○	
		Adjustable								
Heavy Duty	Jeans, heavyweight items	Normal Dry	High	54		○	○	○	○	
		Adjustable								
Normal	Work clothes, corduroys, etc.	Normal Dry	Medium	Elec : 67 Gas : 63		○	○	○	○	○
		Adjustable								
Perm. Press	Permanent press, synthetic items	Normal Dry	Low	32		○	○	○	○	
		Adjustable								
Towels	Denims, towels, heavy cottons	Normal Dry	Mid High	55		○		○	○	
		Adjustable								
Sportswear	Sports Wear	Off	-	27		○			○	
Delicates	Lingerie, sheets, blouses	Normal Dry	Low	28		○		○	○	
		Adjustable								
Speed Dry	For small loads with short drying times	Off	High	25	○	○			○	
			Adjustable	Adjustable						
Air Dry	For items that require heat-free drying such as plastics or rubber	Off	No Heat	30	○	○				
				Adjustable						

### Sensor dry cycles

Sensor dry cycles utilize LG's unique dual sensor system to detect and compare the moisture level in clothes and in the air and adjust the drying time as needed to ensure superior results. The dryer automatically sets the dryness level and temperature at the recommended setting for each cycle. The estimated time remaining will be shown in the display.

#### NOTE

To protect your garments not every dryness level, temperature, or option is available with every cycle. See the **Cycle Guide** for details.

### Downloaded

If you download a cycle using the Tag On feature, it will be placed in the downloaded cycle position. Choose the Downloaded cycle to run the downloaded cycle.

### Manual dry cycles

Use manual dry cycles to select a specific amount of drying time and a drying temperature. When a manual dry cycle is selected, the Estimated Time Remaining display shows the actual time remaining in your cycle. You can change the actual time in the cycle by pressing More Time or Less Time.



**CERTIFIED BY NSF/P154**

NSF International (formerly the National Sanitation Foundation), certifies that the Anti Bacterial cycle reduces 99.9% of bacteria on laundry, and none of the bacteria will carry over onto the next laundry load.

- The default settings for the **Anti Bacterial** cycle are **High** temperature and **Very Dry**. These default settings cannot be changed.
- Do NOT use this cycle with delicate items or fabrics.

## Cycle Settings and Options

### Cycle Modifier Buttons

SENSOR DRY cycles have preset settings that are selected automatically. MANUAL DRY cycles have default settings, but you may also customize the settings using the cycle modifier buttons. Press the button for that option to view and select other settings.

#### Dry Level

Selects the level of dryness for the cycle. Press the **Dry Level** button repeatedly to scroll through available settings.

- This option is only available with SENSOR DRY cycles.
- The dryer will automatically adjust the cycle time. Selecting More Dry or Very Dry will increase the cycle time, while Less Dry or Damp Dry will decrease the cycle time.
- Use a Less Dry or Damp Dry setting for items that you wish to iron.

#### Temp.

Adjusts the temperature setting. This allows precise care of your fabrics and garments. Press the **Temp. Control** button repeatedly to scroll through available settings.

#### Time Dry

Allows you to manually select the drying time, from 20 to 60 minutes, in 10-minute increments. Use this for small loads or to remove wrinkles.

#### More Time/Less Time

Use the **More Time/Less Time** buttons to add or reduce the drying time of a MANUAL DRY cycle in 1-minute increments.

#### Signal (Option)

Press the **Signal (Option)** button repeatedly to change the volume or turn on/off the button tones and the end of cycle melody.

### Cycle Option Buttons

The dryer features several additional cycle options to customize cycles to meet individual needs. Certain option buttons also feature a special function that can be activated by pressing and holding that option button for 3 seconds. (See Special Functions on the following page for details.)

#### Adding Cycle Options to a Cycle:

- 1 Turn on the dryer and press the CYCLE buttons to select the desired cycle.
- 2 Use the cycle modifier buttons to adjust the settings for that cycle.
- 3 Press the cycle option button(s) for the option you would like to add. A confirmation message is shown in the display.
- 4 Press the **START/PAUSE** button to start the cycle. The dryer starts automatically.

#### Wrinkle Care

Selecting this option will tumble the load periodically for up to 3 hours after the selected cycle, or until the door is opened. This is helpful in preventing wrinkles when you are unable to remove items from the dryer immediately.

#### Damp Dry Signal

With this option, the dryer will signal when the load is approximately 80% dry. This allows you to remove faster-drying lightweight items or items that you would like to iron or hang while still slightly damp.

## Special Functions

Some cycle option buttons also activate secondary functions. These special functions are marked with an asterisk (\*). Press and hold the option button marked with the special function to activate it.

### \* Drum Light

The drum is equipped with a blue LED that illuminates when the dryer is turned on. This light automatically turns off when the door is closed and the cycle starts. To turn on the light during a cycle, press and hold the TurboSteam button for three seconds. The drum light will illuminate and then turn off automatically after four minutes.

### \* Child Lock

Use this option to prevent unwanted use of the dryer or to keep cycle settings from being changed while the dryer is operating.

Press and hold the button marked **Child Lock** for 3 seconds to activate or deactivate the Child Lock function. The Child Lock icon will be shown in the display, and all controls will be disabled except the **POWER** button.

#### NOTE

Once set, Child Lock remains active until it is manually deactivated. Child Lock must be turned off to run another cycle. To deactivate Child Lock, press and hold the **Child Lock** button for 3 seconds.

### Energy Saver (on some models)

This option helps to reduce energy consumption in the Normal cycle, depending on the load size. When the Energy Saver option is selected, the cycle begins with an air dry section and the drying time is increased.

#### NOTE

The Energy Saver option is turned on by default in the Normal cycle. Turn off the Energy Saver option for a faster Normal cycle which begins with heated drying.

### \* Default On/Off

This option allows the Energy Saver settings to be changed. To run a Normal cycle without the Energy Saver option, press and hold the Energy Saver button for three seconds. ON or OFF appears in the display.

## Custom PGM

If you have a special combination of settings that you use frequently, you can save these settings as a custom program.

### Saving a Custom Program:

- 1 Turn on the dryer and press the CYCLE buttons to select the desired cycle.
- 2 Use the cycle setting buttons to adjust the settings for that cycle.
- 3 Press the cycle option button(s) for the option you would like to add. A confirmation message will be shown in the display.
- 4 Press and hold the **Custom PGM** button for 3 seconds.

#### NOTE

You may save only one custom program at a time. Pressing and holding the **Custom PGM** button will overwrite any previously saved custom program.

### Recalling a Custom Program:

- 1 Turn on the dryer.
- 2 Press the **Custom PGM** button.
- 3 Press the **START/PAUSE** button to start the cycle.

## Steam Functions

LG's new steam technology allows you to inject fabrics with a swirling jet of hot steam to refresh clothes and reduce static, or sanitize clothes. Simply select the Steam Fresh™ cycle or the Steam Sanitary™ cycle. Or you can add a steam option to selected cycles.

### Using the Steam Fresh™ cycle

Steam Fresh™ uses the power of steam alone to quickly reduce wrinkles and odors in fabrics. It brings new life to wrinkled clothes that have been stored for an extended time. Steam Fresh™ can also be used to help reduce odors and remove the hanger creases in fabrics.

#### NOTE

- Depending on the load size, change the cycle time by pressing More Time or Less Time. The display shows 1, 3, 5, or  $\frac{b}{i} \frac{g}{j}$ . Select 3 for up to three items; select 5 for four or five items; and select  $\frac{b}{i} \frac{g}{j}$  for a large load, a bulky item like a blanket, or to remove hanger creases.

### To use the Steam Fresh™ cycle:

- 1 Turn on the dryer and turn the cycle selector knob to select the Steam Fresh™ cycle.
- 2 To add an option function, select Wrinkle Care.
- 3 Depending on the load (quantity of items), steam time can be changed by pressing the More Time or Less Time buttons.
- 4 Press Start/Pause button to start the cycle.

### Using the Steam Sanitary™ cycle

The new Steam Sanitary™ cycle is ideal for sanitizing non-washable items quickly and easily using the power of steam alone. This cycle is recommended for use with cotton and polyester materials. (Do NOT use for urethane foam, down feathers or delicate items.)

### Using the steam options:

The Reduce Static option injects steam late in the drying cycle to reduce the static electricity caused by dry fabrics rubbing together. Change the amount of time for the cycle by pressing the More Time or Less Time button, depending on the load (quantity of items). The display will show the recommended number of items, such as 7, 9, 11, 14, 16, or 18. TurboSteam helps prevent the overdrying of clothes by injecting steam during the drying process. The Steam Shield Function extends the life of clothes.

#### NOTE

- When Sensor Dry is selected with the Reduce Static or Turbo Steam option, a Dry level of Less or Damp cannot be selected.
- The Reduce Static option may also be selected during Time Dry cycles.
- After the Steam option is selected in Time Dry, the More Time or Less Time buttons will change the steam time only.
- After pressing Start/Pause, the More Time or Less Time buttons will be disabled.

### To add steam to a standard cycle:

- 1 Turn on the dryer and turn the cycle selector knob to select the desired cycle.
- 2 Use the cycle setting buttons to adjust the settings for that cycle.
- 3 Press the steam option button for the steam option you would like to add. Then adjust for the load size using the More Time or Less Time buttons.
- 4 Press Start/Pause to start the cycle.

**WARNING**

- **Do not open the dryer door during steam cycles.** Failure to follow this warning can cause serious injury or death.
- **Do not fill the steam feeder with gasoline, drycleaning solvents, or other flammable or explosive substances.** Failure to do so can result in death, explosion, fire, or burns.
- **Do not touch the steam nozzle in the drum during or after the steam cycle.** Failure to follow this warning can cause serious injury or death.

**NOTE**

- When Sensor Dry is selected with the Reduce Static or Turbo Steam option, a dry level of Less or Damp cannot be selected.
- The Reduce Static option may also be selected during Time Dry cycles.
- After the steam option is selected in Time Dry, the More Time or Less Time buttons will change the steam time only.
- After pressing Start/Pause, the More Time or Less Time buttons will be disabled.

**Steam Cycle Guide**

	Steam	Default Time	Temp. Control	Dry Level	Fabric State	Fabric Type	Maximum Amount
<b>Steam Sanitary™</b>		31 minutes			Dry	Comforter Bedding	Single (1 each)
			Children's clothing	3 lbs.			
<b>Steam Fresh™</b>		10 minutes	○		Dry	Comforter	Single (1 each)
						Shirts*	5 each
<b>Steam Option</b>	+ Reduce Static	Follows Selected Cycle		○	Wet	Varies by selected cycle	8 lbs. (18 Items.)
	+ Turbo Steam			○	Wet	Varies by selected cycle	8 lbs. (18 Items.)
<b>Time Dry</b>	+ Reduce Static	38 minutes	○		Wet	Varies by selected cycle	8 lbs. (18 Items.)

\*Shirt: 70% cotton:30% poly blend. Except especially delicate fabrics.

- When the lint filter or exhaust duct is clogged, steam options will not give proper results.
- For best results, load articles of similar size and fabric type. Do not overload.



# SMART FEATURES

## Tag On (on some models)

### Before Using Tag On

The Tag On function allows you to conveniently use the LG Smart Diagnosis™, Cycle Download, Laundry Stats and Tag On Cycle Set features to communicate with the appliance from a smart phone. To use the Tag On function:

- 1 Download the LG Smart Laundry & DW application to the smart phone.
- 2 Turn on the NFC (Near Field Communication) function on the smart phone. The Tag On function can only be used with smart phones equipped with the NFC function and based on the Android operating system (OS).

### Turning On the Smart Phone's NFC Function

- 1 Enter the Settings menu of the smart phone and select **Share & connect**.

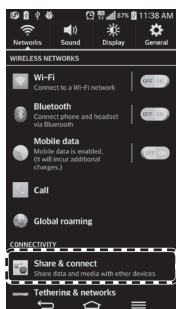

- 2 Set **NFC** to **ON**.



#### NOTE

Depending on the smart phone manufacturer and Android OS version, the NFC activation process may differ. Refer to the manual of the smart phone for details.

### Using the Tag On Function

#### The Tag On Icon

Look for the Tag On icon on the right side of the dryer's control panel. Position the smart phone over the icon when using the Tag On function with the LG Smart Set features of the LG Smart Laundry & DW application.

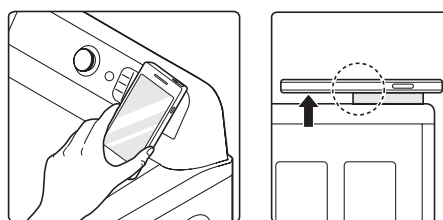
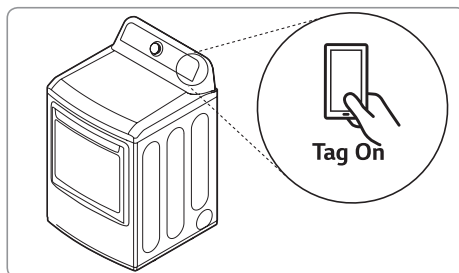

### The NFC Antenna Position

When you use the Tag On function, position your smart phone so that the NFC antenna inside the back of your smart phone matches the position of the Tag On icon on the appliance. (Because you cannot see the position of the antenna, the LG Smart Laundry & DW app will attempt to find it for you and show you a target range for the antenna on your smart phone's screen.)

If the app is not able to show a target range, try positioning the center back of your smart phone over the Tag On icon on the appliance. If the connection is not made immediately, move your smart phone very slightly in a widening circular motion until the application verifies the connection.

Because of the characteristics of NFC, if the transmission distance is too far, or if there is a metal sticker or a thick case on the phone, transmission will not be good.

Press [ ? ] in the LG Smart Laundry & DW app for a more detailed guide on how to use the Tag On function.

## Using Tag On With Apps

LG Smart Diagnosis™, Cycle Download, Laundry Stats and Tag On Cycle Set in the LG Smart Laundry & DW apps use the Tag On function when you touch the LG appliance's Tag On logo with your NFC-equipped smart phone.

### NOTE

Images are for reference only. The actual LG Smart Laundry & DW application is subject to change for product improvement purposes.

- Before using the LG Smart Diagnosis™, Cycle Download, Laundry Stats and Tag On Cycle Set, download the application from the Google Play Store and install it.
- Select Tag On using either the scrollable icons or the stationary bottom icons.

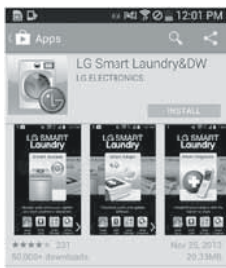

## Tag On Diagnosis

The Tag On Diagnosis app helps you to troubleshoot problems with your appliance using the Tag On function and an NFC-equipped smart phone based on the Android operating system (OS).

- 1 Select **Tag On Diagnosis**.

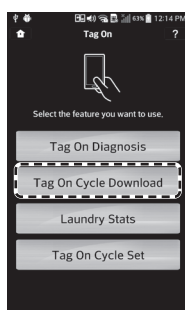

- 2 Touch the **Tag On** logo.

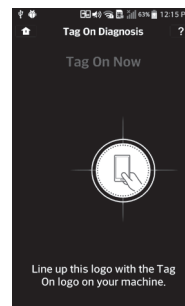

- 3 Check the diagnosis results and solutions.

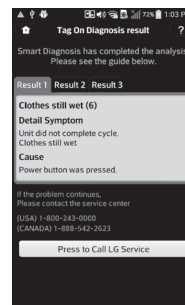

- The app shows the diagnosis results of the cycles recently used.
- If the results are unclear, or if they suggest calling the LG Service Center, see the Call Center Diagnosis section for instructions.

## Call Center Diagnosis

If you receive a diagnosis from either the Tag On Diagnosis or Smart Diagnosis™ app that is unclear or directs you to call the LG Service Center, follow these instructions:

- 1 Select **Press to Call LG Service** on the Smart Diagnosis Result screen.

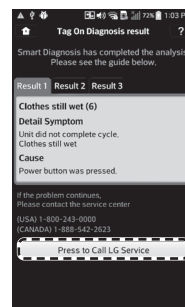

- 2 Select your country.

- 3 Agree to Terms and Conditions of the Use and Privacy Policy by pressing **I accept**.

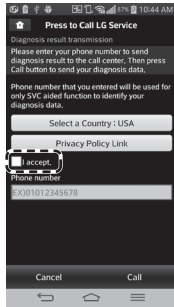

- 4 Enter your phone number in the field. Use this phone number when talking to LG Customer Service to allow them to find your Smart Diagnosis data.

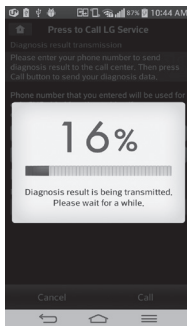

- 5 Press the Call button to initiate the call to LG's Support Center.

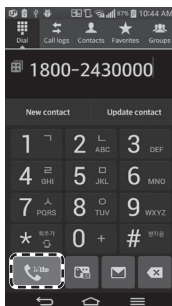

## Tag On Cycle Download

Tag On Cycle Download allows you to download cycles for later use. The cycle is available at the Download Cycle position on the control panel until another cycle is downloaded.

- 1 Select **Tag On Cycle Download**.

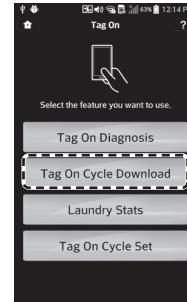

- 2 Touch the **Tag On** logo.

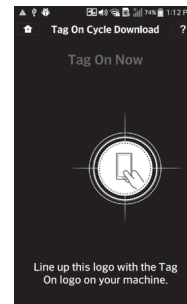

- 3 Select a cycle to download.

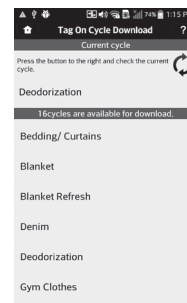

- The current downloaded cycle is at the top of the screen and the available cycles are below that. You can also confirm the existing downloaded cycle.

**4** Touch the **Tag On logo**.

- When a Tag On screen appears, tap your smart phone on the Tag On icon on the right side of the dryer's control panel.

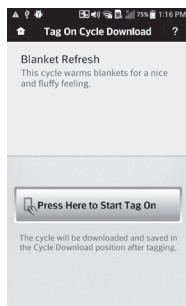

**5** The new cycle is downloaded successfully!

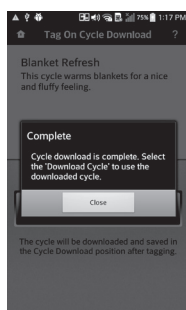

- Check whether the new cycle is downloaded by turning the cycle selector knob to Download Cycle.

**Laundry Stats**

Tag On Laundry Stats allows you to check the Flow Sense status on your appliance to check if your home exhaust system is clogged and also display the details of your last ten cycles.

**Flow Sense™ Status**

- LG's Flow Sense duct blockage sensing system detects and alerts you to restrictions in the installed household ductwork that reduce exhaust airflow through the dryer.

**1** Select **Laundry Stats**.

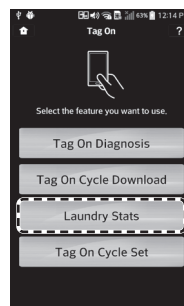

**2** Touch the **Tag On logo**.

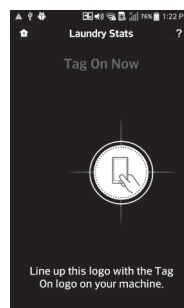

**3** Check the Flow Sense status result.



**4** If the status shows your home exhaust system is blocked, press the **Venting Tips** button.

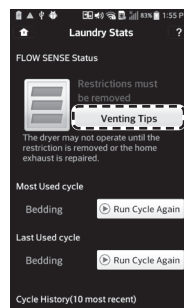

## Run Cycle Again

- 1 Select the **Run Cycle Again** button.
  - The Most Used cycle or Most Recent cycle can be immediately started by selecting the Run Cycle Again button.



- 2 Touch the **Tag On** logo.

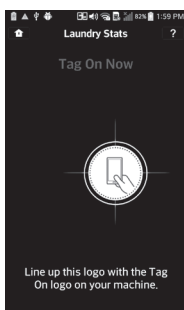

- 3 Check whether drying starts with the selected cycle.

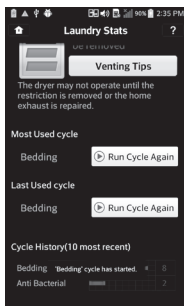

- The screen shown above appears and drying starts immediately on the selected cycle.

## Tag On Cycle Set

Tag On Cycle Set allows you to automatically adjust the cycle and settings based on your laundry needs.

- 1 Select **Tag On Cycle Set**.

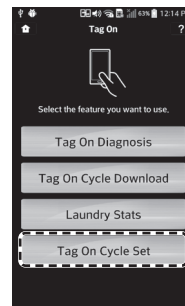

- 2 Touch the **Tag On** logo.

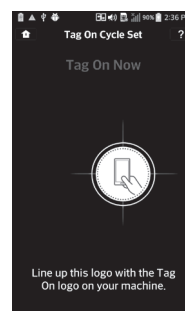

- 3 Select a laundry category based on the issue you want the machine to focus on.

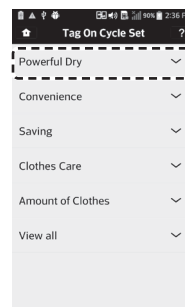

- 4 After selecting the category, a list of specific cycles will appear. Select the cycle based on your needs.

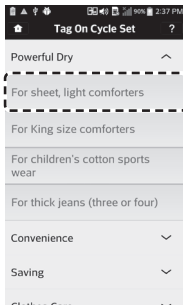

- 5 When the Tag On screen appears, tap your smart phone to the Tag On logo on the right side of the dryer's control panel.

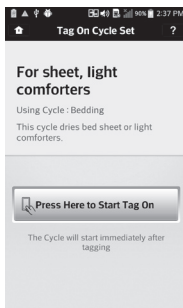

- 6 After tagging the machine with your phone, the cycle will automatically start. Verify that the correct cycle and settings were selected.

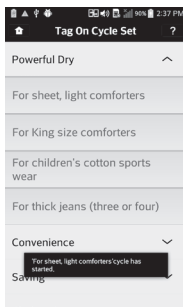

# MAINTENANCE

## Regular Cleaning

### WARNING

To reduce the risk of fire, electric shock, or injury to persons when using this appliance, follow basic precautions, including the following:

- **Unplug the dryer before cleaning to avoid the risk of electric shock.** Failure to follow this warning may cause **serious injury, fire, electrical shock, or death.**
- **Never use harsh chemicals, abrasive cleaners, or solvents to clean the washer.** They will damage the finish.

## Cleaning the Exterior

Proper care of your dryer can extend its life. The outside of the machine can be cleaned with warm water and a mild, nonabrasive household detergent. Immediately wipe off any spills with a soft, damp cloth.

### NOTE

- Do not use methylated spirits, solvents, or similar products.
- Never use steel wool or abrasive cleansers; they can damage the surface.

## Cleaning the Interior

Wipe around the door opening and seal with a soft, damp cloth to prevent lint and dust buildup that could damage the door seal.

Clean the window with a soft cloth dampened with warm water and a mild, nonabrasive household detergent, then wipe dry.

The stainless steel drum can be cleaned with a conventional stainless steel cleaner, used according to the manufacturer's specifications. Never use steel wool or abrasive cleansers; they may scratch or damage the surface.

## Cleaning Around and Under the Dryer

Vacuum lint and dust from around the dryer and underneath it regularly. Vent ductwork should be checked for lint buildup and cleaned at least once per year. If any noticeable reduction in airflow or drying performance occurs, immediately check ductwork for obstructions and blockages.

## Maintaining Ductwork

Vent ductwork should be checked for lint buildup once per month and cleaned at least once per year. If any noticeable reduction in airflow or drying performance occurs, immediately check ductwork for obstructions and blockages. Contact a qualified technician or service provider.

## Cleaning the Lint Filter

Always clean the lint from the filter after every cycle.

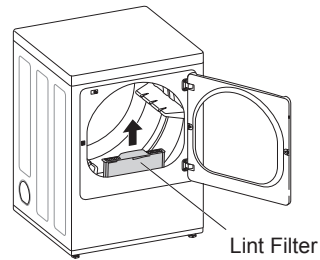

To clean, open the dryer door and pull the lint filter straight up. Then:

- 1 For everyday cleaning, roll any lint off the filter with your fingers, or

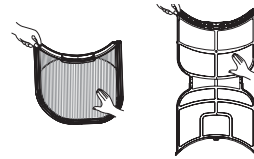

- 2 Vacuum the lint filter.

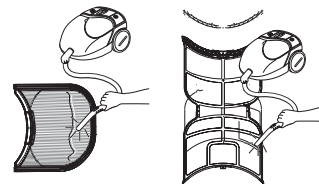

- 3 If the lint filter has become very dirty or clogged with fabric softener, wash the lint filter in warm, soapy water and allow it to dry thoroughly before reinstalling.

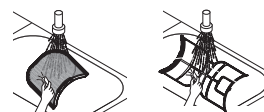

### NOTE

**NEVER** operate the dryer without the lint filter in place. **NEVER** operate the dryer with a wet lint filter.

# TROUBLESHOOTING

## FAQs: Frequently Asked Questions

**Q: When I press a button, why does my dryer beep and then nothing happens?**

A: The Child Lock feature is turned on. To turn off Child Lock, turn the dryer on, then press and hold the button that has \*Child Lock on or under it for 3 seconds.

**Q: Why does my dryer take so long to dry clothes?**

A: Proper airflow is critical to the efficient operation of clothes dryers. A lint filter which is full of lint or clogged with fabric softener sheet residue can reduce the airflow to the point that the time required to dry clothing will be greatly increased. Another factor affecting dry time is your home exhaust system. An exhaust system which is dirty and clogged with lint, or is excessively long, needs to be professionally cleaned or repaired.

**Q: Why does my dryer start by itself every few minutes?**

A: This is how the Wrinkle Care feature works. The dryer runs briefly every few minutes for up to 3 hours after the cycle finishes. This feature is designed to help prevent wrinkles from setting in when the dryer is not unloaded immediately after the cycle is finished.

**Q: Why does my dryer show 3 minutes when I select the Steam Fresh™ cycle?**

A: When the Steam Fresh™ cycle is selected, the dryer displays the number of garments rather than the estimated cycle time, until the cycle is started. Use the More Time or Less Time buttons to adjust the load size setting for the number of garments you desire. For a large load or single bulky item use the *bi 9* (big) setting.

## User Support Videos

For further assistance, there are videos and tutorials available through the LG.com website.

- 1 On the lg.com/us home page, hover over the Support menu tab to bring up the menu selections. Select **Videos & Tutorials**.
- 2 Type **Dryer** in the search box on the new page and click the Search button.

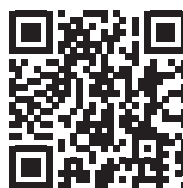

Scan this QR code to quickly access the video search page on the LG website. Once there, type **Dryer** in the search box.



## Before Calling for Service

This dryer is equipped with an automatic error-monitoring system to detect and diagnose problems at an early stage. If the dryer does not function properly or does not function at all, check the following before you call for service.

### Operation

Problem	Possible Cause	Solutions
<b>The Flow Sense™ indicator remains active after clearing the restriction in the venting.</b>	<b>After clearing the restriction, the Flow Sense™ system requires multiple, consecutive cycles to determine that the performance value has improved before the Flow Sense™ indicator is reset.</b>	If the Flow Sense™ indicator remains active for more than five cycles after the restriction has been cleared, call for service.
<b>Dryer will not turn on</b>	<b>Power cord is not properly plugged in.</b>	Make sure that the plug is securely plugged into a grounded outlet matching the dryer's rating plate.
	<b>House fuse is blown, circuit breaker has tripped, or power outage has occurred.</b>	Reset circuit breaker or replace fuse. Do not increase fuse capacity. If the problem is a circuit overload, have it corrected by a qualified electrician.
<b>Dryer does not heat</b>	<b>House fuse is blown, circuit breaker has tripped, or power outage has occurred.</b>	Reset circuit breaker or replace fuse. Do not increase fuse capacity. If the problem is a circuit overload, have it corrected by a qualified electrician.  <b>NOTE</b> Due to the design of electric dryers, it is possible for a circuit problem to allow an electric dryer to run without heat.
	<b>Gas supply or service is turned off (gas models only).</b>	Confirm that the house gas shutoff and the dryer gas shutoff valves are both fully open. Even if gas is not supplied to the dryer, it will run and no error codes will display. Verify that other gas appliances in the home are working normally.
	<b>Energy Saver option selected (on some models)</b>	If using the Cotton/Normal cycle, deselect the energy saver option. The Energy Saver option is selected by default. This option reduces energy use by adding an air dry section to the beginning of the cycle. It is normal to feel no heat at the beginning of the cycle while in Energy Saver mode.
<b>Display show error code nP or gAS</b>	<b>Power cord connection is incorrect.</b>	Check the connection of power cord to the terminal block.
	<b>Gas supply or service turned off (Gas models only).</b>	Confirm that house gas shutoff and the dryer gas shutoff are both fully open

Problem	Possible Cause	Solutions
Clothes take too long to dry	Exhaust ducts are blocked, dirty, or duct run is too long.	Confirm that the exhaust duct is properly configured and free of debris, lint, and obstructions. Make sure that outside wall dampers can open properly and are not blocked, jammed, or damaged.
	Load is not properly sorted.	Separate heavy items from lightweight items. Larger and heavier items take longer to dry. Light items in a load with heavy items can fool the sensor because the light items dry faster.
Clothes take too long to dry	Large load of heavy fabrics.	Heavy fabrics take longer to dry because they tend to retain more moisture. To help reduce and maintain more consistent drying times for large and heavy fabrics, separate these items into smaller loads of a consistent size.
	Dryer controls are not set properly.	Use the appropriate control settings for the type of load you are drying. Some loads may require an adjustment of the dry level setting for proper drying.
	Lint filter needs to be cleaned.	Remove the lint from the filter before every load. With the lint removed, hold the filter up to a light to see if it is dirty or clogged. With some loads that produce high amounts of lint, such as new bath towels, it may be necessary to pause the cycle and clean the filter during the cycle.
	House fuse is blown, circuit breaker has tripped, or power outage has occurred.	Reset circuit breaker or replace fuse. Do not increase fuse capacity. If the problem is a circuit overload, have it corrected by a qualified electrician.  <b>NOTE</b> Due to the design of electric dryers, it is possible for a circuit problem to allow an electric dryer to run without heat.
	Dryer is overloaded.	Divide extra large loads into smaller loads for better drying performance and efficiency.
Dryer is underloaded.	If you are drying a very small load, add a few extra items to ensure proper tumbling action. If the load is very small and you are using SENSOR DRY cycles, the electronic control cannot properly sense the dryness of the load and may shut off too soon. Use TIME DRY or add some extra wet clothes to the load.	

Problem	Possible Cause	Solutions
<b>Clothes take too long to dry</b>	<b>Energy Saver option selected (on some models)</b>	If using the Cotton/Normal cycle, deselect the Energy Saver option. This option reduces energy use by adding an air dry section to the beginning of the cycle.
<b>Drying time is not consistent</b>	<b>Heat settings, load size, or dampness of clothing is not consistent.</b>	The drying time for a load will vary depending on the type of heat used (electric, natural gas, or LP gas), the size of the load, the type of fabrics, the wetness of the clothes, and the condition of the exhaust duct and lint filter. Even an unbalanced load in the washer can cause poor spinning, resulting in wetter clothes which will take longer to dry.

## Performance



Problem	Possible Cause	Solutions
<b>Greasy or dirty spots on clothes</b>	<b>Fabric softener used incorrectly.</b>	Confirm and follow the instructions provided with your fabric softener.
	<b>Clean and dirty clothes are being dried together.</b>	Use your dryer to dry only clean items. Soil from dirty clothes can transfer to the clean clothes in the same or later loads.
	<b>Clothes were not properly cleaned or rinsed before being placed in the dryer.</b>	Stains on dried clothes could be stains that were not removed during the washing process. Make sure that clothes are being completely cleaned or rinsed according to the instructions for your washer and detergent. Some difficult soils may require pre-treating prior to washing.
<b>Clothes are wrinkled</b>	<b>Clothes dried too long (over dried).</b>	Over drying a load of laundry can lead to wrinkled clothes. Try a shorter drying time or LESS DRY setting and remove items while they still retain a slight amount of moisture.
	<b>Clothes left in dryer too long after cycle ends.</b>	Use the WRINKLE CARE option. This feature will tumble the clothes briefly every few minutes for up to 3 hours to help prevent wrinkling.
<b>Clothes are shrinking</b>	<b>Garment care instructions are not being followed.</b>	To avoid shrinking your clothes, always consult and follow fabric care instructions. Some fabrics will naturally shrink when washed. Other fabrics can be washed but will shrink when dried in a dryer. Use a low or no heat setting.
<b>Lint on clothes</b>	<b>Lint filter not cleaned properly.</b>	Remove the lint from the filter before every load. With the lint removed, hold the filter up to a light to see if it is dirty or clogged. If it looks dirty, follow the cleaning instructions. With some loads that produce high amounts of lint, it may be necessary to clean the filter during the cycle.
	<b>Laundry not sorted properly.</b>	Some fabrics are lint producers (i.e., a fuzzy white cotton towel) and should be dried separately from clothes that are lint trappers (i.e., a pair of black linen pants).

Problem	Possible Cause	Solutions
<b>Lint on clothes</b>	<b>Excess static in clothes.</b>	Use a fabric softener to reduce static electricity. Be sure to follow the manufacturer's instructions. Overdrying a load of laundry can cause a buildup of static electricity. Adjust settings and use a shorter drying time, or use SENSOR DRY cycles.
	<b>Dryer is overloaded.</b>	Divide extra large loads into smaller loads for drying.
	<b>Tissue, paper, etc., left in pockets.</b>	Check pockets thoroughly before washing and drying clothes.
<b>Excess static in clothes after drying</b>	<b>Fabric softener is not used or used incorrectly.</b>	Use a fabric softener or the STATIC SHIELD option, if equipped, to reduce static electricity. Be sure to follow the manufacturer's instructions.
	<b>Clothes dried too long (overdried).</b>	Overdrying a load of laundry can cause a buildup of static electricity. Adjust settings and use a shorter drying time, or use AUTO DRY cycles. Select a LESS DRY setting on SENSOR DRY cycles, if necessary.
	<b>Drying synthetics, permanent press, or synthetic blends.</b>	These fabrics are naturally more prone to static buildup. Try using fabric softener, or use LESS DRY and/or shorter TIME DRY time settings.
<b>Clothes have damp spots after a SENSOR DRY cycle.</b>	<b>Very large load or very small load. Single large item such as a blanket or comforter.</b>	<p>If items are too tightly packed or too sparse the sensor may have trouble reading the dryness level of the load. Use a Time Dry cycle for very small loads.</p> <p>Large, bulky items such as blankets or comforters can sometimes wrap themselves into a tight ball of fabric. The outside layers will dry and register on the sensors, while the inner core remains damp. When drying a single bulky item, it may help to pause the cycle once or twice and rearrange the item to unwrap and expose any damp areas.</p> <p>To dry a few remaining damp items from a very large load or a few damp spots on a large item after a sensor cycle has completed, empty the lint trap, then set a Time Dry cycle to finish drying the item(s).</p>

## Steam Functions (Steam Models)

Problem	Possible Cause	Solutions
Water drips from nozzle when STEAM CYCLE starts	This is normal.	This is steam condensation. The dripping water will stop after a short time.
Garments still wrinkled after Steam Fresh™	Too many or overly different types of garments in dryer.	Small loads of 1 to 5 items work best. Load fewer garments. Load similar types of garments.
Creases or pleats are gone from garments after Steam Fresh™	The function of this cycle is to remove wrinkles from fabric.	Use an iron to replace creases and pleats in garments.
Garments have static after using the Reduce Static option	This is normal.	The amount of static experienced will depend on the individual moisture level in the skin.
Garments are too damp or too dry after using the Reduce Static option	Correct drying options not selected.	Select the load weight manually before starting the Reduce Static option.
Garments are not uniformly damp after using the Easy Iron option	Number of garments or load size not properly selected at the beginning of the cycle.	Select the correct number of garments or load size before starting the cycle.
Steam does not generate, but no error code is shown	Water level error.	Unplug dryer and call for service.
Water drips from door during STEAM CYCLE	This is normal.	Condensation will normally form on the inside of the dryer door during steam operation. Some condensation may drip out the bottom of the door.
Steam is not visible during STEAM CYCLE	This is normal.	Steam vapor is difficult to see when the door is closed. However, condensation will normally form on the inside of the dryer door if the steam system is operating normally.
Drum does not turn during STEAM CYCLE	This is normal.	The drum is turned off so that the steam vapor remains in the drum. The drum will normally turn for about 2 seconds once a minute.
Cannot see steam vapor at the beginning of cycle	This is normal.	Steam is released at different stages of the cycle for each option.
Odors remain in clothing after Steam Fresh™	Steam Fresh™ did not remove odor completely.	Fabrics containing strong odors should be washed in a normal cycle.

## Error Codes

Problem	Possible Cause	Solutions
Error code: tE1 through tE7	Temperature sensor failure.	Turn off the dryer and call for service.
Display shows error code: PS (electric dryers only)	Power cord is connected incorrectly.	Check the connection of the power cord to the terminal block.
*Flow Sense™ indicator shows four bars during the drying cycle or the display shows "d80" after drying  * This warning light is not a dryer failure and is not covered by the dryer warranty. Contact a duct cleaning service to set up an appointment to have your exhaust system cleaned and inspected.	Exhaust system is too long or has too many turns/restrictions.  Partial blockage of the ductwork due to lint buildup or other foreign object.  The appliance has detected a restriction in the external dryer venting.	Install a shorter or straighter duct run. See the Installation Instructions for details.  Ductwork should be checked/cleaned immediately. Dryer can be used in this condition, but drying times will be longer and energy consumption will increase.  If exhaust restrictions are sensed by the Flow Sense™ system, the indicator will remain on for 2 hours after the end of the cycle. Opening the door or pressing the <b>POWER</b> button will turn off the display.
The Flow Sense™ indicator remains active after clearing the restriction in the venting.	After clearing the restriction, the Flow Sense™ system requires multiple, consecutive cycles to determine that the performance value has improved before the Flow Sense™ indicator is reset.	If the Flow Sense™ indicator remains active for more than five cycles after the restriction has been cleared, call for service.
 indicator light is on during the drying cycle	Water supply error.	Check steam feeder drawer: (1) Make sure the steam feeder is filled with water to the MAX line. (2) Make sure the steam feeder is seated properly and the drawer is fully closed. (3) Turn the dryer off then restart the STEAM CYCLE.  Do not use distilled water; the water level sensor in the steam generator will not work.  Pump not working. Unplug dryer and call for service.
The display shows  619	More Time button was pressed.	This display indicates that the steam option has been set for a "big" item such as a comforter.  Press the Less Time button to reduce the indicated load size.
 Clean Filter indicator light is on during the drying cycle	Lint filter not cleaned properly.	Remove the lint from the filter before every load. With the lint removed, hold the filter up to a light to see if it is dirty or clogged. If it looks dirty, follow the cleaning instructions. With some loads that produce high amounts of lint, it may be necessary to clean the filter during the cycle.

Problem	Possible Cause	Solutions
<p><i>Add</i> indicator light is on during the drying cycle</p>	<p><b>Water supply error.</b></p>	<p>Check steam feeder drawer:</p> <p>(1) Make sure the steam feeder is filled with water to the MAX line.</p> <p>(2) Make sure the steam feeder is seated properly and the drawer is fully closed.</p> <p>(3) Turn the dryer off then restart the STEAM CYCLE.</p> <p>Do not use distilled water; the water level sensor in the steam generator will not work.</p>
<p>The display shows d90, d95</p> 	<p><b>The duct work is about 90%-95% blocked. ("d90" or "d95" error code is displayed for 2 hours only)</b></p> <p><b>House exhaust system blocked.</b></p>	<p>Do not use the dryer until the exhaust system has been cleaned and/or repaired. Using the dryer with a severely restricted exhaust is dangerous and could result in a fire or other property damage.</p> <p>Check the outside dryer vent while the dryer is operating to make sure there is strong airflow.</p> <p>If the exhaust system is extremely long, have it repaired or rerouted.</p> <p>Keep the area around the dryer clean and free of clutter.</p> <p>Check vent hood for damage or lint clogging.</p> <p>Make sure the area around the vent hood is clear.</p>



# SMART DIAGNOSIS™



Should you experience any problems with your dryer, it has the capability of transmitting data to your smart phone using the LG Smart Laundry Application or via your telephone to the LG call center.

Smart Diagnosis™ cannot be activated unless your dryer is turned on by pressing the **POWER** button. If your dryer is unable to turn on, then troubleshooting must be done without using Smart Diagnosis™.

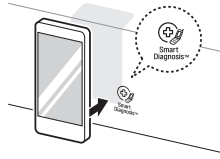

## Using Smart Diagnosis™

### Smart Diagnosis™ Using Your Smart Phone

- 1 Download the LG Smart Laundry & DW application on your smart phone.
- 2 Open the LG Smart Laundry application on your smart phone. Press the right arrow button to advance to the next screen.
- 3 Press the Record button on the smart phone and then hold the mouth piece of the smart phone near the Smart Diagnosis™ logo on the dryer.
- 4 With the phone held in place, press and hold the Temp. Control button for 3 seconds.
- 5 Keep the phone in place until the tone transmission has finished. The display will count down the time.
- 6 When the recording is complete, view the diagnosis by pressing the Next button on the phone.

#### NOTE

- Call quality differences by region may affect the function.
- Use a home telephone for better communication performance, resulting in better service.
- Poor call quality may result in poor data transmission from your phone to the machine, which could cause Smart Diagnosis™ to malfunction.

### Smart Diagnosis™ Through the Call Center

- 1 Call the LG call center at: (LG U.S.)  
1-800-243-0000  
(LG Canada) 1-888-542-2623.
- 2 When instructed to do so by the call center agent, hold the mouthpiece of your phone over the Smart Diagnosis™ logo on the machine. Hold the phone no more than one inch from (but not touching) the machine.

#### NOTE

Do not touch any other buttons or icons on the display screen.

- 3 Press and hold the Temp. Control button for 3 seconds.
- 4 Keep the phone in place until the tone transmission has finished. The display will count down the time.
- 5 Once the countdown is over and the tones have stopped, resume your conversation with the call center agent, who will then be able to assist you in using the information transmitted for analysis.

#### NOTE

- For best results, do not move the phone while the tones are being transmitted.
- If the call center agent is not able to get an accurate recording of the data, you may be asked to try again.



This product qualifies for ENERGY STAR in the "factory default (Home Use)" setting. Changing the factory default settings or enabling other features may increase power consumption that could exceed the limits necessary to qualify for ENERGY STAR.

LG Customer Information Center

**1-800-243-0000** USA

**1-888-542-2623** CANADA

Register your product Online!

[www.lg.com](http://www.lg.com)