

DW80J3020 Series



Dishwasher user manual

imagine the possibilities

Thank you for purchasing this Samsung product.



SAMSUNG

contents

SETTING UP YOUR DISHWASHER

6

- 6 Unpacking your dishwasher
- 6 Checking parts
- 7 Meeting installation requirements

USING YOUR DISHWASHER

8

- 8 Control panel
- 9 Cycle selector
- 10 Progress lights
- 10 Display
- 11 Basic guidelines for operation
- 13 Removing the plate support
- 14 Adjusting the height of the upper rack
- 14 Removing the upper rack
- 15 Loading the lower rack
- 15 Loading the upper rack
- 16 Using the cutlery basket
- 17 Using the dispenser

CLEANING AND MAINTAINING YOUR DISHWASHER

19

- 19 Cleaning the exterior
- 19 Cleaning the interior
- 19 Cleaning the nozzles
- 20 Storing your dishwasher

CYCLES

21

- 21 Cycle chart

TROUBLESHOOTING

22



- 22 Check these points if your dishwasher...
- 25 Information codes

APPENDIX

26











- 26 Helping the environment
- 26 Specifications

safety information

Throughout this manual, you'll see Warning  and Caution  notes. These important safety instructions do not cover all possible situations that might occur. It is your responsibility to use caution when installing, maintaining, and operating your dishwasher. Samsung will not be liable for any damage resulting from improper use.

IMPORTANT SAFETY INSTRUCTIONS

What the icons and signs in this user manual mean :

 WARNING	Hazards or unsafe practices that may result in severe personal injury or death .
 CAUTION	Hazards or unsafe practices that may result in personal injury or property damage .
 CAUTION	To reduce the risk of fire, explosion, electric shock, or personal injury when using your dishwasher, follow these basic safety precautions:
	Do NOT attempt.
	Do NOT disassemble.
	Do NOT touch.
	Follow directions explicitly.
	Unplug the power plug from the wall socket.
	Make sure the machine is grounded to prevent electric shock.
	Call the service center for help.



When using the dishwasher, follow basic precautions, including the following:



Read all instructions before using the dishwasher.

As with any equipment using electricity, water, and moving parts, potential hazards exist.

Use the dishwasher only for its intended function.

Use only detergents or wetting agents recommended for use in a dishwasher, and keep them out of the reach of children.

When loading items to be washed:

- Locate sharp items so that they are not likely to damage the door seal, and
- Load sharp knives with the handles up to reduce the risk of cut-type injuries.



Do not wash plastic items unless they are marked "dishwasher safe" or the equivalent. For plastic items not so marked, check the manufacturer's recommendations.



Do not touch the HEATING ELEMENT during or immediately after use.

SAVE THESE INSTRUCTIONS

safety information



WARNING : When using your dishwasher, follow basic precautions, including the following:

1. Read all instructions before using the dishwasher.
2. Use the dishwasher only for its intended function.
3. Use only detergents or wetting agents recommended for use in a dishwasher and keep them out of the reach of children.
4. When loading items to be washed:
 - locate sharp items so that they are not likely to damage the door seal, and
 - load sharp knives with the handles up to reduce the risk of cut-type injuries.
5. Do not wash plastic items unless they are marked “dishwasher safe” or the equivalent. For plastic items not so marked, check the manufacturer’s recommendations.
6. Do not touch the HEATING ELEMENT during or immediately after use.
7. Do not operate your dishwasher unless all ENCLOSURE panels are properly in place.
8. Do not tamper with controls.
9. Do not abuse, sit on, or stand on the door or dish rack of the dishwasher.
10. To reduce the risk of injury, do not allow children to play in or on a dishwasher.
11. Under certain conditions, hydrogen gas may be produced in a hot-water system that has not been used for two weeks or more. HYDROGEN GAS IS EXPLOSIVE. If the hot-water system has not been used for such a period, before using the dishwasher turn on all hot-water faucets and let the water flow from each for several minutes. This will release any accumulated hydrogen gas. As the gas is flammable, do not smoke or use an open flame during this time.
12. Remove the door to the washing compartment when removing an old dishwasher from service or discarding it.



State of California Proposition 65 Warning (US only)

WARNING: This product contains chemicals known to the State of California to cause cancer, birth defects, or other reproductive harm.



- After unpacking the dishwasher, keep the packaging out of the reach of children.
- The dishwasher is extremely heavy. Do not attempt to move or carry the dishwasher by yourself. Two or more people are needed to move a dishwasher and avoid potential injuries.
- As with any equipment using electricity, water, and moving parts, potential hazards exist.
- Do not install the dishwasher near electrical components. Keep the dishwasher away from open flames.
- Install and level your dishwasher on an uncarpeted floor that can support its weight.
- Your dishwasher must be properly grounded. Never connect it to an ungrounded outlet. See page 7 for more information on grounding your dishwasher.
- Connect the ground wire to the green ground connector in the terminal box.
- After the dishwasher is installed, check that the drain hose is properly connected and that there is no leakage from the hose connectors. If the drain hose is loose, it may cause property damage.
- The water supply line is susceptible to breakage. As time goes by, it becomes less flexible. Check the line periodically. If it is swollen, torn, cut, or there is a water leak, replace it immediately.
- To safely operate this appliance, familiarize yourself with its operations and exercise care when using it.

SAVE THESE INSTRUCTIONS

- Do not put gasoline, solvents, or other flammable materials inside the dishwasher. Do not wash dishes exposed to these materials.
- Keep your dishwasher detergent out of the reach of children. Detergent has an adverse effect on human organs. It contains elements for polishing and is corrosive. Avoid letting the detergent come into contact with your skin and eyes.
- Do not push or place pressure on the door when it is open, as this may damage the dishwasher or cause harm.
- Do not allow children to play in or on the dishwasher. They may harm themselves or damage the dishwasher.
- Disconnect the power cable (or set the circuit breaker to off) before servicing your dishwasher.
- Do not repair, replace, or service any part of your dishwasher yourself. Disassembly, repairs, and modifications are permitted by authorized service technicians only. Work done by an unauthorized person may void your warranty.
- Before disposing of your dishwasher, remove the door of the washing compartment or the door latch so that children or small animals cannot get trapped inside.
- If the dishwasher is left unused for an extended period of time, turn off the water supply.
- This dishwasher is intended for residential use only.

BEFORE USING YOUR DISHWASHER



WARNING



Tip-Over Hazard

- Do not use the dishwasher until it is correctly installed.
- Do not push down on an open door.
- Do not place excessive weight on the open door.



Electric Shock Hazard

- Failure to follow these instructions can result in death, fire, or electric shock:
- Electrically ground the dishwasher
 - Connect the ground wire to the green ground connector in the junction box.
 - Do not use an extension cord.

SAVE THESE INSTRUCTIONS

setting up your dishwasher

Be sure to have your installer follow these instructions closely so that your new dishwasher works properly and that you're not at risk of injury when washing dishes.

UNPACKING YOUR DISHWASHER

- Once your new dishwasher has been delivered to you, carefully unpack it and check for any damage. If the dishwasher has been damaged, make note of it on the waybill and keep a copy. Do not install the dishwasher, and contact Samsung Customer Service at the number listed below.
- If there is no damage to the product, you can proceed with the installation. If you are going to install it yourself, make sure to read through the installation guide and follow the directions inside.
- After unpacking your dishwasher, keep the packaging out of the reach of children to ensure their safety.

CHECKING PARTS

When your dishwasher has been unpacked, make sure you've received all the parts shown below. If your dishwasher was damaged during shipping, or if you do not have all the parts, contact **Samsung Customer Service at 1-800-SAMSUNG (726-7864)**

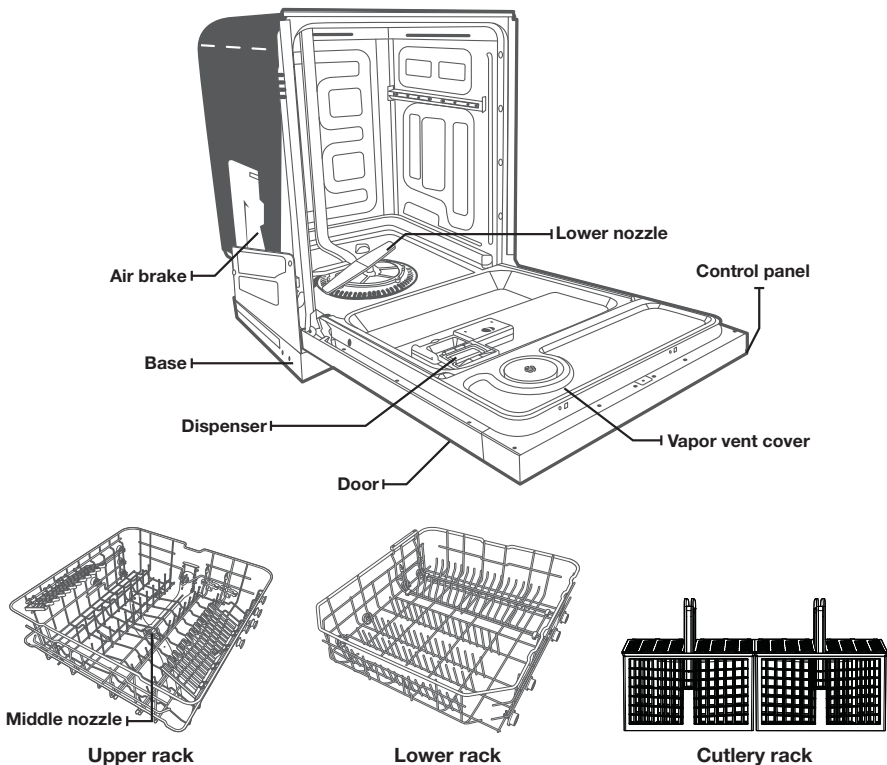

 Accessory parts - User/Installation manual, Installation Kit.

MEETING INSTALLATION REQUIREMENTS

Electrical supply and grounding

 To prevent the risk of fire, electric shock, or personal injury, all wiring and grounding must be done in accordance with the National Electrical Code ANSI/FNPA, No. 70 Latest Revision and local codes and ordinances. It is the personal responsibility of the appliance owner to provide adequate electrical service for this appliance.



Never use an extension cord.

When preparing for installation, ensure that your power supply provides:

- An individual branch circuit serving only your dishwasher with a 120 V~, 60 Hz, 15 AMP fuse or circuit breaker.

Your dishwasher must be grounded. If your dishwasher malfunctions or breaks down, grounding will reduce the risk of electric shock by providing a path of least resistance for the electric current.



Never connect the ground wire to plastic plumbing lines, gas lines, or hot water pipes.

GROUNDING INSTRUCTIONS

For a permanently connected appliance:

This appliance must be connected to a grounded metal, permanent wiring system, or an equipment-grounding conductor must be run with the circuit conductors and then connected to the equipment-grounding terminal or lead on the appliance.

Water supply

The hot water supply line pressure must be between 20 - 120 psi (140 - 830 kPa).

Adjust the water heater to deliver water between 120 °F (49 °C) - 149 °F (65 °C).

 Most plumbing supply stores sell water supply lines of various lengths up to 10 feet (305 cm) long.

You can reduce the risk of leaks and water damage by:

- Making water faucets easily accessible.
- Turning off faucets when the dishwasher is not in use.
- Periodically checking for leaks at water supply line fittings.



Before using your dishwasher for the first time, check all connections at the water supply valve and faucets for leaks.

Flooring

For safety, your dishwasher must be installed on a solidly constructed floor.

Never install your dishwasher on a platform or poorly supported structure.

Your dishwasher must be properly installed in accordance with the Installation Guide before you use it. If you did not receive an Installation Guide with your dishwasher, you can obtain one by visiting our website at www.samsung.com.

using your dishwasher

CONTROL PANEL

DW80J3020 Series

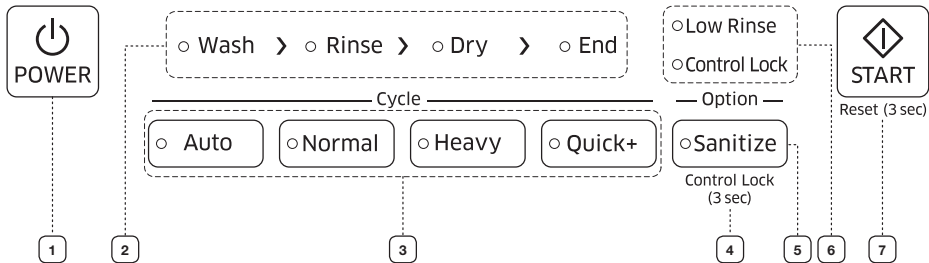

<p>1 POWER</p>	<p>When you press the POWER button, the entire display turns on and off, and then the light of the most recently finished cycle lights up.</p> <p>When the cycle you selected has finished, all other indicator lights are turned off and the “End” light is illuminated for 10 minutes.</p> <p>Then, the Power turns off automatically.</p>
<p>2 PROGRESS LIGHT</p>	<p>Progress information (Wash, Rinse, Dry, End)</p> <p>The progress light that corresponds to the current operation turns on to show the progress of the cycle.</p>
<p>3 CYCLE SELECTOR</p>	<p>Select the appropriate wash cycle depending on the soil level of your dishes. After you select a cycle, the Cycle On light for that cycle lights up.</p> <p>If you want to cancel the selected cycle, press the selected cycle button again.</p>
<p>4 CONTROL LOCK</p>	<p>This option allows you to lock the buttons on the control panel so children cannot accidentally start the dishwasher by pressing the buttons on the panel.</p> <p>To lock and unlock the buttons on the control panel, hold the Sanitize button down for three (3) seconds.</p> <ul style="list-style-type: none"> - When Power is On : Hold down the Sanitize button for three (3) seconds. - When Power is Off : Push the POWER button first, and then hold down the Sanitize button for three (3) seconds.
<p>5 SANITIZE</p>	<p>During the Sanitize cycle, the temperature rises to 162 °F (72 °C) in the final rinse cycle for high temperature sanitization.</p> <p>If you select the Sanitize option, the “Sanitize” lamp blinks when the water temperature reaches the sanitary temperature (over 155 °F (68 °C)), and then remains illuminated until the Sanitize option ends. When you open the door or press the POWER button, the “Sanitize” lamp turns off.</p> <p> The Sanitize feature operates in accordance with NSF/ANSI Standard 184 for Residential Dishwashers. Certified residential dishwashers are not intended for licensed food establishments. Your dishwasher is NSF Certified.</p> <p>The cycle that is NSF certified is the Heavy Cycle with the sanitize option selected.</p>

6 DISPLAY	Displays information (Low Rinse, Control Lock). The “ Low Rinse ” light turns on when you need to refill the rinse aid agent and the “ Control Lock ” light turns on/off when you activate Control Lock/Unlock .
7 START	To start the cycle, press the POWER button, select the cycle and options you want, and then press the START button to begin the cycle. To cancel a cycle currently running and drain the dishwasher, hold down the START button for three (3) seconds.

 You can select the **Sanitize** option before starting a cycle. If you change the cycle after selecting an option, the original cycle is reset.

CYCLE SELECTOR

DW80J3020 Series

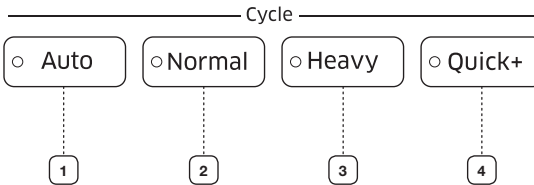

1 Auto	This cycle detects the level of soil and automatically initiates the optimal cycle after a few minutes of operation.
2 Normal	Use this cycle for regular dinner dishes.
3 Heavy	Use this cycle for heavily soiled dishes.
4 Quick+	Use this cycle for lightly soiled dishes.

using your dishwasher

PROGRESS LIGHTS

DW80J3020 Series

○ Wash > ○ Rinse > ○ Dry > ○ End

1

2

3

4

1	Wash	When the dishwasher is in a wash portion of a cycle, the “Wash” light is illuminated.
2	Rinse	When the dishwasher is in a rinse portion of a cycle, the “Rinse” light is illuminated.
3	Dry	When the dishwasher is in a drying portion of a cycle, the “Dry” light is illuminated.
4	End	After the dishwasher has completed all portions of a cycle, all other indicator lights are turned off and the “End” light is illuminated for 10 minutes. If you open the door when the “End” light is illuminated, it turns off immediately.

 When the dishwasher starts a cycle, the light corresponding to the current operation turns on to show the progress of the cycle. When that portion of the cycle is complete, the illuminating light turns off.

DISPLAY

DW80H3020 Series

○ Low Rinse 1

○ Control Lock 2

1	Low Rinse	When “Low Rinse” remains illuminated, the rinse aid dispenser is empty or nearly empty. Refill the rinse aid agent dispenser.
2	Control Lock	When you select Control lock, the “Control Lock” indicator light is illuminated.

BASIC GUIDELINES FOR OPERATION

1. Open the door and load your dishes (see page 15).
 - Remove any food remains from the dishes before placing them in the rack(s).
 - Place dishes into the upper and lower racks.
 - After placing the dishes into the racks, rotate the nozzles by hand to check whether any of the dishes will interfere with them.
 - Make sure the dishes will not prevent the detergent dispenser from opening.
2. Add detergent to the dispenser (see page 17).
 - Make sure to use only automatic dishwasher detergent.
 - Refer to **“Using the dispenser”** on how to add detergent.
3. Close the door, and then press the **POWER** button.
 - When you press the **POWER** button, the entire display turns on and off, and then the cycle light of the most recently finished cycle lights up.
 - If **“Low Rinse”** is illuminated, you should refill the rinse aid dispenser to improve washing and drying performance.
4. Select an appropriate cleaning cycle depending on the soil level of the dishes (see pages 9 and 21).
 - Press the appropriate cycle button.
 - When you press a cycle button, the cycle indicator light is illuminated. If you press the cycle button again, the light turns off and the cycle is canceled.
 - For information about selecting a cycle according to the soil level of the dishes, see **“Cycle selector”** on page 9.
5. Press the **START** button.
 - After you close the door and press the **START** button or you press the **START** button and close the door, the dishwasher starts the selected cycle after a few seconds.
6. When the wash cycle is completed.
 - The **“End”** light illuminates and the dishwasher sounds a chime.
 - The power is automatically turned off after 10 minutes.



If you want to load more dishes or pause the dishwasher while it is already running, make sure to open the door slowly and carefully as there is a possibility of injury from the hot steam inside the dishwasher. (If the door is opened while the dishwasher is running, a safety mechanism is activated and stops the cycle.)



You should use rinse aids for better drying performance. You can further improve drying performance by also selecting the **Sanitize** option.

If the **“Low Rinse”** lamp lights during a cycle, the dishwasher adds 30 more minutes to the Drying cycle automatically after the **“End”** light illuminates.

When the water temperature of the last rinse of the sanitize option reaches the sanitary temperature (over 155 °F (68 °C)), the **“Sanitize”** lamp blinks, and then remains illuminated until the **Sanitize** option ends. When you open the door or press the **POWER** button, the **“Sanitize”** lamp turns off.

using your dishwasher



Do not wash the following items

- **Acrylic of Aluminum items:** Dishes with printed gold rim decoration may become discolored.
- **Dishes treated with adhesive:** Treated plastics, wood, ivory, copper, and tin may come loose.
- **Plastics with a temperature tolerance less than 194 °F (90 °C) :** Thin plastics wash and dry poorly, and may be damaged due to elevated wash temperatures.
- **Tin:** Tin should be washed by hand and dried immediately as it may rust.
- **Wooden utensils:** Wooden items may crack.



When using the dishwasher, try to arrange the dishes properly as described on page **15**.

- You should remove food remains such as bones, fruit seeds, etc. and any other waste such as toothpicks, paper, etc. from the dishes as these may cause damage to the dishes, create noise, or cause the dishwasher to malfunction.
- Select the appropriate cycle depending on the level of soil and the type of dishes.
- Use only the proper amount of detergent and rinsing agent.

REMOVING THE PLATE SUPPORT

You can adjust the angle of the tines in the upper rack to three different positions to match the size and shape of your dishes. To adjust the tines, grasp the handle at the back of the rack and push it left or right. See the illustration below.

In the lower rack, you can easily remove the plate support to make room for large items such as pots and pans. To remove the plate support, lift up the handles (A). To refit the plate support, align it so it is in place, and then push down on the handles (A). To fold down the fold-down tines on the lower rack, remove the rack from the dishwasher, turn the rack over, grasp the tine (B), and then adjust it backward. See the illustration below.

Upper rack

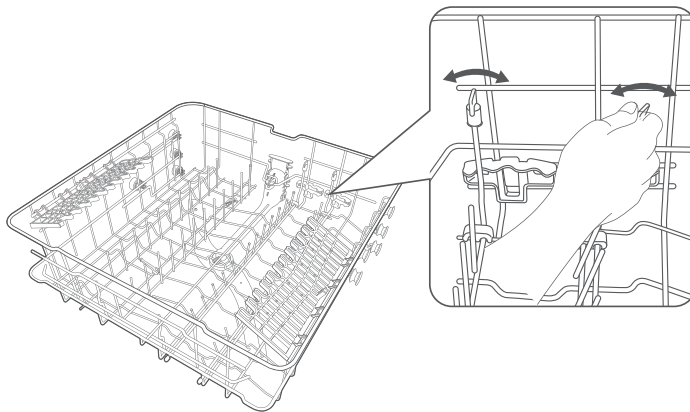

Lower rack

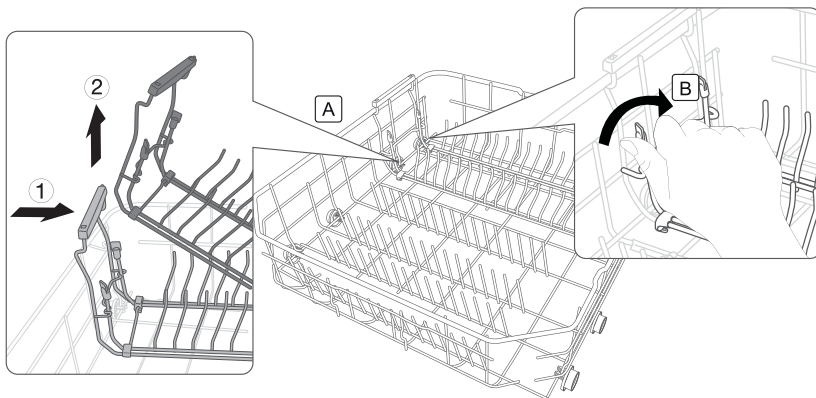

using your dishwasher

ADJUSTING THE HEIGHT OF THE UPPER RACK

You can adjust the height of the upper rack in your Samsung dishwasher so that the lower rack can accommodate larger sized dishes. Depending on where you set the upper rack height, the lower rack can accommodate plates up to 14 in. (36 cm) in diameter and the upper rack can accommodate plates up to 12 in. (30 cm) in diameter.

DW80J3020 Series

To adjust the height of the upper rack, follow these steps:

1. Remove the upper rack following the directions in **Removing the Upper Rack** below.
2. If you want to lower the upper rack, re-install the rack as shown in Figure **A** to the right.
3. If you want to raise the upper rack, re-install the rack as shown in Figure **B** to the right.



We recommend adjusting the height of the upper rack before loading dishes into the rack. If you adjust the the rack after loading the dishes, you may damage the dishes.

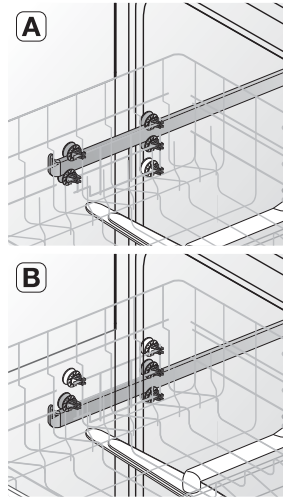

REMOVING THE UPPER RACK

Pull the upper rack towards the front and then remove it by lifting it up slightly and pulling it towards the front. See the illustrations below.



While the upper rack is removable, it must be installed for the dishwasher to operate properly. If you attempt to operate the dishwasher without the rack, noise will occur and the dishwasher will perform poorly.

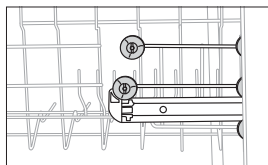

Step 1.

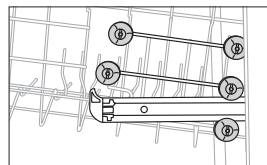

Step 2.

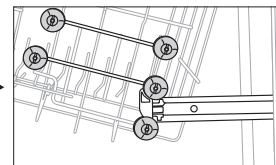

Step 3.

LOADING THE LOWER RACK

Load cookware (pots, pans, etc.), up to 14 in. (36 cm) in diameter into the lower rack. The lower rack has been especially designed for dinner dishes, soup bowls, plates, lids, casserole dishes, and plates. Load your plates into the center column of the rack so their open sides face towards the right. Load large items such as pans and pots into the dishwasher so their open sides face downwards. We recommend loading cups, stemware, and small plates into the upper rack. See the recommended loading patterns below.



8 place setting



10 place setting



12 place setting

LOADING THE UPPER RACK

The upper rack has been designed for small plates, mugs, glasses, and plastic items marked "dishwasher safe". Load your plates into the dishwasher so their open sides face each other. Make sure the loaded dishes do not interfere with the rotation of the nozzle which is located at the bottom of the upper rack. (Check this by rotating the nozzle by hand.) When loading dishes, pull the upper rack out sufficiently so you can load it without striking the counter above.



8 place setting

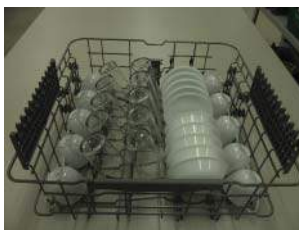

10 place setting



12 place setting

Using the glass support

You can load cups or glasses onto the glass support. This is also very convenient for washing wine glasses. Hang your wine glasses onto the pegs of the glass support.

You can fold the glass support back when it is not being used.

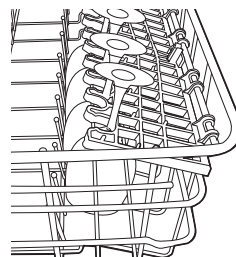

using your dishwasher

Loading the large items

You can load large items such as pans and pots into the lower rack. Make sure pot handles and other items do not interfere with rotation of the nozzles.



USING THE CUTLERY BASKET

The cutlery basket consists of two compartments.

You can place each knife, spoon, or fork separately into the spoon stands in the basket's covers to prevent chipping and discoloration.

 DO NOT let any item extend through the bottom.

- 1 Small forks
- 2 Spoons
- 3 Knives
- 4 Large spoons and forks
- 5 Medium-sized forks
- 6 Remaining items

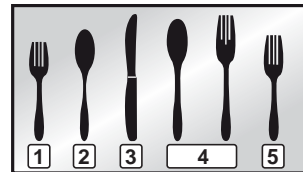

Suggested arrangement for a 12 place setting

The spoon stands as seen from above with the suggested placement of cutlery items. Match the numbers in the diagram to the numbers in the list of cutlery items above.

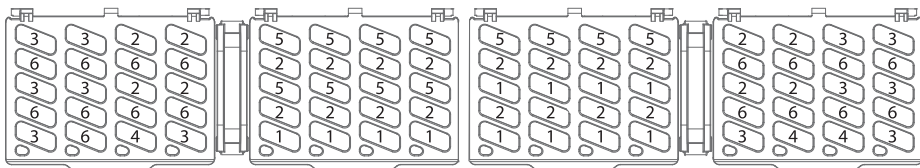

You can use the cutlery basket with the cover open. Refer to the illustration to the right.

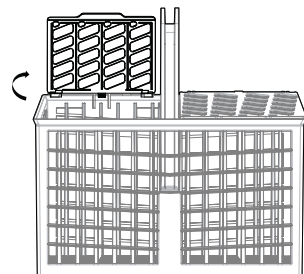

USING THE DISPENSER

Filling the detergent dispenser

1. Open the cover by pushing the cover latch downwards.

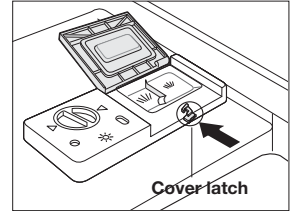

2. Add the recommended amount of detergent to the main wash dispenser. See the table below.

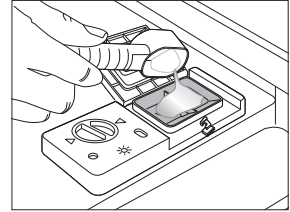

3. Close the dispenser cover. You will hear a 'click' when it is closed correctly.

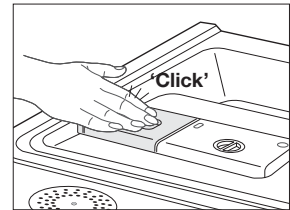

4. When you select the **Heavy** cycle, add the recommended amount of detergent to the pre-wash dispenser. See the table below.

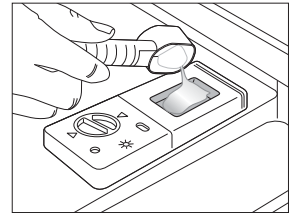

The cover opens automatically to dispense the detergent during the wash.

CYCLE	AMOUNT OF DETERGENT	
	Main wash dispenser	Pre-wash dispenser
Auto, Normal, Quick+	0.5 oz (15 g)	No detergent
Heavy	0.7 oz (20 g)	0.2 oz (5 g)

 The numbers inside the dispenser refer to grams.

using your dishwasher

Filling the rinse aid dispenser

Your dishwasher has been designed to use liquid rinse aid.

 The use of a rinse aid greatly improves the drying performance after the final rinse.

1. Turn the dispenser knob counterclockwise to open the cover.

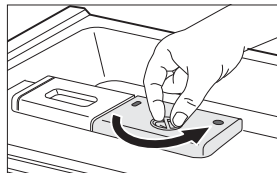

2. Pour rinse aid into the opening until the indicator points to "MAX". Avoid overfilling the dispenser.

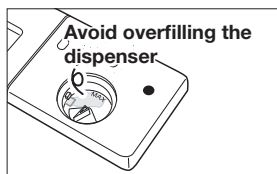

3. Adjust the amount of rinse aid released during the rinse operation.

You can choose one of four levels (1 - 4). The higher the number, the larger the amount of rinse aid released. The factory default is 3.

When the rinse dispenser is filled up, it is good for about 40 washes.

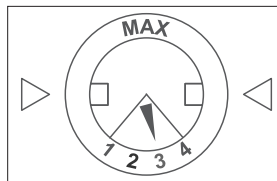

4. Close the cover.
Turn the dispenser knob clockwise.

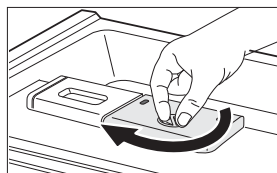

We strongly recommended using only liquid rinse aid.

cleaning and maintaining your dishwasher

Keeping your dishwasher clean improves its performance, reduces unnecessary repairs, and lengthens its life.

CLEANING THE EXTERIOR

It's best to clean spills on the outside of your dishwasher as they occur. Use a soft, damp cloth on the control panel to gently wipe away spills and dust. Do not use benzene, wax, thinner, chlorine bleach, or alcohol. These materials may discolor the inner walls and cause stains. Do not clean the dishwasher by sprinkling water over it and avoid letting water come into contact with any of the electrical parts.



If your dishwasher has a stainless steel door panel, you can clean it with a stainless steel cleaner for home appliances or a similar product using a clean, soft cloth.

CLEANING THE INTERIOR

Clean the interior of your dishwasher periodically to remove any dirt or food particles. Wipe the inside of the dishwasher and the inner part of the door with a wet dishcloth. We recommend filling the detergent dispenser with dish detergent, and then running the dishwasher empty periodically using the **Normal** cycle with the sanitize option. This will keep your dishwasher clean.

If white spots and odor are still present in your dishwasher, run the **Normal** cycle with the dishwasher empty and without detergent until it flushes. Then, interrupt the cycle and put an 8 ounce cup of white vinegar into the lower basket. Close the dishwasher and let the cycle finish.



Do not remove the tub front seal (the long rubber seal enclosing the opening of the dishwasher).

CLEANING THE NOZZLES

If your dishwasher does not seem to be cleaning adequately or the nozzles seem clogged, you can clean each of the nozzles. When removing the nozzles, take care as they may break.

Lower nozzle

1. Check whether the nozzle holes are clogged by food particles.
2. If cleaning is needed, remove the nozzle by pulling it upwards.
3. Clean the nozzle, and then push it back into place.
4. Check whether the nozzle is engaged correctly by rotating it by hand.

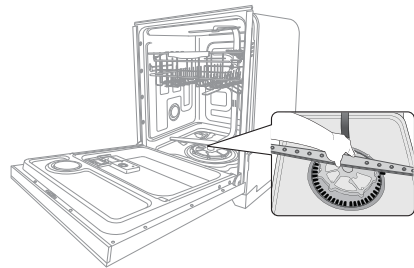

cleaning and maintaining your dishwasher

Middle nozzle

1. Pull the upper rack towards the front and remove it.
2. Check whether the nozzle holes are clogged by food particles.
3. If cleaning is needed, remove the nozzle.
4. To remove the nozzle, unfasten and remove the nut, and then remove the nozzle.
5. Clean the nozzle, re-insert it, and then fasten the nut.
6. When fastening the nut, turn it firmly by hand.
7. Check whether the nozzle is engaged correctly by rotating it by hand.

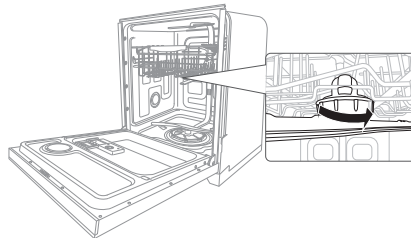

Upper nozzle

1. Check whether the nozzle holes are clogged by food particles.
2. If cleaning is needed, remove the nozzle.
3. To remove the nozzle, pull out the upper rack first, unfasten the nozzle cap by turning it counterclockwise, and then remove the upper nozzle.
4. Clean the nozzle, re-insert it, and then fasten the nozzle cap to the nozzle by turning the cap clockwise.
5. Check whether the nozzle is engaged correctly by rotating it by hand.

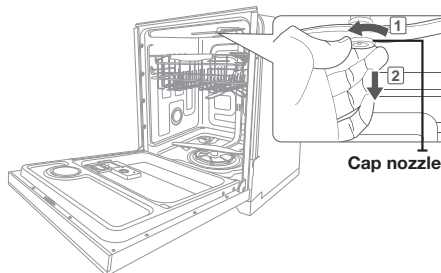

STORING YOUR DISHWASHER

If you need to store your dishwasher for an extended period of time, first drain and disconnect it. If you leave water in the hoses and internal components, you can damage the dishwasher.

After draining and disconnecting the dishwasher, be sure to turn off the water supply valve and circuit breaker.

cycles

CYCLE CHART

(●: Basic, ○: Optional)

Cycle	Prewash1	Prewash2	Main wash	Rinse1	Rinse2	Rinse3	Last Rinse [Sanitize]	Dry	Water [gal(ℓ)]
Auto	●	○	● 122 - 138 °F (50 - 59 °C)	●	○	-	● 138 °F (59 °C) 162 °F (72 °C)	●	3.6 - 6.7 (13.7 - 25.2)
Normal	●	○ 113 °F (45 °C)	● 118 - 145 °F (48 - 63 °C)	●	○	-	● 136 - 149 °F (58 - 65 °C) 162 °F (72 °C)	●	2.8 - 7.2 (10.7 - 27.2)
Heavy	●	●	● 140 °F (60 °C)	●	●	●	● 158 °F (70 °C) 162 °F (72 °C)	●	8.6 (32.5)
Quick+	●	-	● 140 °F (60 °C)	●	-	-	● 140 °F (60 °C)	●	5.0 (18.8)

- The numbers in parentheses in the Last Rinse column represent the temperature when you select **Sanitize**. (When you select **Quick+**, you can't use the **Sanitize** option.)
- When you select the **Auto** or **Normal** cycle, you can eliminate the ○ (optional) steps depending on the soil level of the dishes.
- The wash time varies depending on the steps or options you add, and on the pressure and temperature of the supplied water.

troubleshooting

CHECK THESE POINTS IF YOUR DISHWASHER...

PROBLEM	ACTION
Does not start. (Dishwasher doesn't run)	<ul style="list-style-type: none">• Make sure the door is latched and closed completely. Make sure the upper rack is properly joined with the duct nozzle. Also, make sure the upper rack is properly assembled with no imbalances.• Make sure the door is latched and closed completely. Press START before closing the door.• Make sure the dishwasher is turned on and the door is closed completely. Make sure the power cord is properly plugged into the wall outlet.• Make sure the power cord is connected properly.• Make sure the water supply is connected properly and the water is turned on.• The control panel may be locked. Make sure Control Lock is not activated.• A cycle may not be selected. Make sure a cycle is selected.• A circuit breaker is open. Reset the circuit breaker.• A fuse is blown. Replace the fuse. Disconnect any other appliances sharing the same circuit with the dishwasher.
Has odors.	<ul style="list-style-type: none">• Apply detergent, and run the Normal cycle with no dishes inside.• Water remains from an incomplete cycle. Apply detergent without loading dishes, and run the Normal cycle to clean the dishwasher.• The drain hose is obstructed. Contact a qualified service technician to remove any obstruction from the drain hose.• The dishwasher is not being used daily, or soiled dishes are left in the dishwasher too long. With the dishwasher empty and no detergent, place a glass with 8 ounces of vinegar upright into the lower rack, and then run a Normal cycle.
Water remains after a cycle has finished.	<ul style="list-style-type: none">• The drain hose is bent or clogged. Contact a qualified service technician to remove any obstruction from the drain hose.

PROBLEM	ACTION
<p>Food particles remain on dishes. (Not cleaning properly.)</p>	<ul style="list-style-type: none"> • An incorrect cycle was selected. Select a cycle according to the soil level of the dishes as directed in this manual. • No dishwasher detergent or not enough detergent is being used. Use an automatic dishwasher detergent (powder or gel type) or use more detergent. • The water pressure is low. The water pressure must be between 20 - 120 psi (140 - 830 kPa). • See the maintenance section of this user manual and clean the nozzle. • The dishes are improperly loaded. Rearrange the dishes so they have good water access and they do not interfere with the spray arm and dispenser operation. Load only an appropriate number of dishes. Load the dishes as recommended (See page 15). • The water temperature is low. Connect the water supply line to a hot water supply. For best performance, the temperature of the supplied water should be 120 °F (49 °C). <p>The water is too hard. For hard water:</p> <ul style="list-style-type: none"> • Use a commercial dishwasher cleaner. • Use high-quality, fresh detergent with rinse aid. <ul style="list-style-type: none"> • Make sure large items such as cookie sheets, cutting boards, or containers, etc. are not blocking the detergent dispenser and preventing it from opening properly. • Rearrange the dishes so they do not interfere with detergent dispenser operation. <div data-bbox="388 730 529 865" style="text-align: center;"> </div> <ul style="list-style-type: none"> • There is no rinse aid. Check the dispenser and add rinse aid. Use liquid type rinse aid. • Rearrange the dishes so they do not interfere with nozzle rotation and detergent dispenser operation. • Prior to loading, scrape food from dishes. (Do not pre-rinse.)
<p>Does not dry dishes well.</p>	<ul style="list-style-type: none"> • Not enough or no rinse aid is used. Check the dispenser and add rinse aid, and check the rinse aid setting. • Glasses and cups with concave bottoms hold water, causing water to spill when you unload. After a cycle finishes, unload the lower rack first and then the upper, this will prevent water spilling from the upper rack onto the dishes in the lower rack. • The water temperature is low. Connect the water supply line to a hot water supply and use rinse aid with the Sanitize option. • Too many dishes have been loaded. Proper loading of items can affect drying. Load dishes as recommended. • When drying is complete, try touching inside the dishwasher and the loaded dishes. If any of these does not feel warm, call for service.
<p>Is too noisy.</p>	<ul style="list-style-type: none"> • Make sure that the dishwasher is level. • See the user manual and reload dishes as instructed. • Sound is generated when the dispenser cover is open and the drain pump is operating during an early stage. This is normal. • Foreign material (screws, pieces of plastic, etc.) is in the pump chamber. Contact a qualified service technician to remove foreign material from the pump chamber. • Utensils are not secure, or small objects have dropped into the basket. Make sure everything is secured in the dishwasher. • The motor may hum if the dishwasher has not been used regularly. If you do not use it often, remember to set it to fill and pump out every week, which will help keep the seal moist.

troubleshooting

PROBLEM	ACTION
There is yellow or brown film on the inside of the dishwasher.	<p>Caused by coffee and tea soils.</p> <ul style="list-style-type: none"> • Use a cycle with a higher temperature. • Remove the soils using a spot cleaner. • Use a solution of 1/2 cup of bleach and 3 cups warm water to remove the stains by hand. <p> To avoid burns, after a cycle, wait for 20 minutes to let the heating elements cool down before cleaning the interior.</p>
Film on glasses.	<ul style="list-style-type: none"> • The water supplied is soft, and too much detergent is being used. Underload the dishwasher and use a rinse aid to minimize this. • Aluminum dishes have been included in the load. Remove the marks on the dishes using a non-abrasive cleaner.
Does not have any indicators lit.	<ul style="list-style-type: none"> • The power cord may not be connected. Connect the power cord.
Does not have a smoothly rotating nozzle.	<ul style="list-style-type: none"> • See the maintenance section of this user manual and clean the spray arms. • Dishes are blocking the nozzle. After placing the dishes into the racks, rotate the nozzles by hand to check whether any of the dishes interfere with them.
White coating on cutlery or crockery.	<p>Hard water is being supplied.</p> <ul style="list-style-type: none"> • Make sure the salt fill indicator and softener setting of your water softener is correct according to the water hardness of your area. • Make sure the salt reservoir cap is correctly fitted.
An operation or cycle takes too long.	<ul style="list-style-type: none"> • Cold water is being supplied. Make sure the water supply line is connected to a hot water supply. (Additional time is required to heat cold water.)
Suds in the tub.	<p>Improper detergent is being used.</p> <ul style="list-style-type: none"> • Use only dishwasher detergent to avoid suds. • Open the dishwasher and let the suds evaporate. • Add 1 gallon of cold water to the tub. Close and latch the dishwasher, then start the Quick+ cycle to drain the water. Repeat if necessary. <hr/> <ul style="list-style-type: none"> • Rinse aid may have spilled. Always wipe up spills immediately.
Water standing in the bottom of the tub.	<ul style="list-style-type: none"> • This is normal. A small amount of clean water around the outlet on the tub bottom keeps the water seal lubricated.
Stained tub interior.	<ul style="list-style-type: none"> • Detergent with colorant is used. Make sure that the detergent does not have colorant.
Steam.	<ul style="list-style-type: none"> • This is normal. Steam comes through the vent by the door latch during drying and water draining.
Buttons do not work.	<p>Control Lock is activated.</p> <ul style="list-style-type: none"> • Buttons do not work when Control Lock is activated. • To deactivate, hold down the Sanitize button for 3 seconds.

INFORMATION CODES

The Control Panel displays information codes to help you understand what is occurring with your dishwasher. The codes take the form of blinking cycle selector lights. If you see any of the codes listed below, you should select the Cancel and Drain option, and then follow the instructions in the Solution column.

Code Symbol	Meaning	Solution
	High temperature heating check	Functional check. With the dishwasher empty, add detergent, and then run a cycle. If the problem continues, go to your house circuit breaker panel, set the dishwasher's circuit breaker switch to off, and then contact an authorized Samsung service center.
	Water supply check	Check whether the faucet is closed, the water supply is suspended, or the water line is frozen or clogged by foreign particles. If the problem continues, Turn off the faucet, and then contact an authorized Samsung service center.
	Over-level water check	Turn off the faucet and go to your house circuit breaker panel, set the dishwasher's circuit breaker switch to off, and then contact an authorized Samsung service center.
	Leakage check	If a water supply valve connection leak occurs, turn off the faucet and go to your house circuit breaker panel, set the dishwasher's circuit breaker switch to off, and then contact your installer or a plumber to fix the leak. If the problem continues, contact an authorized Samsung service center.

For any codes not listed above, call 1-800-SAMSUNG (726-7864)

appendix

HELPING THE ENVIRONMENT

- Your dishwasher is manufactured from materials that can be recycled. If you decide to dispose of it, please observe local waste disposal regulations. Cut off the power cable so that the appliance cannot be connected to a power source.
- Remove the door so that animals and small children cannot get trapped inside the appliance.
- Do not exceed the detergent quantities recommended in the detergent manufacturers' instructions.

SPECIFICATIONS

Model	DW80J3020 Series		
Type	Built-in Dishwasher	Wash capacity	15 place settings
Power	120 V~, 60 Hz only, 15 A circuit breaker	Used water pressure	20 - 120 psi (140 - 830 kPa)
Rated power usage	Wash Motor : 150 - 190 W Heater : 1100 W		
Dimensions (Width×Depth×Height)	23 ⁷ / ₈ x 24 ¹ / ₂ x 33 ⁹ / ₁₀ in. (605 x 621.5 x 860 mm)		
Weight	Unpacked 91.1 lb (41.3 Kg)		

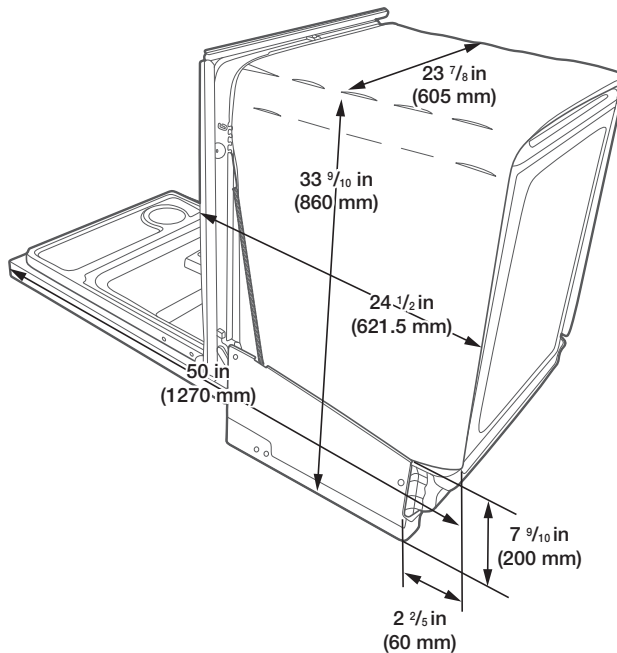

warranty

SAMSUNG DISHWASHER

LIMITED WARRANTY TO ORIGINAL PURCHASER

This SAMSUNG brand product, as supplied and distributed by USA: SAMSUNG ELECTRONICS AMERICA, INC./CANADA: SAMSUNG ELECTRONICS CANADA, INC. (SAMSUNG) and delivered new, in the original carton to the original consumer purchaser, is warranted by SAMSUNG against manufacturing defects in materials and workmanship for a limited warranty period of:

One (1) Year All Parts and Labor, Five (5) Years Printed Circuit Board, Racking (Labor Charges for in-home service starting from the 2nd year is customer's responsibility), and Lifetime Stainless Door Liner & Tub for leakage. Samsung will replace your unit with same or current model (that is better or equivalent in functionality) (Labor related to replacement is customer's responsibility).

This limited warranty begins on the original date of purchase, and is valid only on products purchased and used in the United States/Canada. To receive warranty service, the purchaser must contact SAMSUNG for problem determination and service procedures. Warranty service can only be performed by a SAMSUNG authorized service center. The original dated bill of sale must be presented upon request as proof of purchase to SAMSUNG or SAMSUNG's authorized service center. SAMSUNG will provide in-home service during the warranty period at no charge, subject to availability within the contiguous United States/Canada. In home service is not available in all areas.

To receive in-home service, product must be unobstructed and accessible to the service agent. If service is not available, SAMSUNG may elect to provide transportation of the product to and from an authorized service center.

SAMSUNG will repair, replace, or refund this product at our option and at no charge as stipulated herein, with new or reconditioned parts or products if found to be defective during the limited warranty period specified above. All replaced parts and products become the property of SAMSUNG and must be returned to SAMSUNG. Replacement parts and products assume the remaining original warranty, or ninety (90) days, whichever is longer.

This limited warranty covers manufacturing defects in materials and workmanship encountered in normal, noncommercial use of this product and shall not apply to the following: damage that occurs in shipment; delivery and installation; applications and uses for which this product was not intended; altered product or serial numbers; cosmetic damage or exterior finish; accidents, abuse, neglect, fire, water, lightning, or other acts of nature or God; use of products, equipment, systems, utilities, services, parts, supplies, accessories, applications, installations, repairs, external wiring or connectors not supplied or authorized by SAMSUNG that damage this product or result in service problems; incorrect electrical line voltage, fluctuations and surges; customer adjustments and failure to follow operating instructions, maintenance and environmental instructions that are covered and prescribed in the instruction book; product removal and reinstallation; problems caused by pest infestations. This limited warranty does not cover problems resulting from incorrect electric current, voltage or supply, light bulbs, house fuses, house wiring, cost of a service call for instructions, or fixing installation errors. SAMSUNG does not warrant uninterrupted or error-free operation of the product.

warranty

EXCEPT AS SET FORTH HEREIN, THERE ARE NO WARRANTIES ON THIS PRODUCT EITHER EXPRESS OR IMPLIED, AND SAMSUNG DISCLAIMS ALL WARRANTIES INCLUDING, BUT NOT LIMITED TO, ANY IMPLIED WARRANTIES OF MERCHANTABILITY, INFRINGEMENT OR FITNESS FOR A PARTICULAR PURPOSE. NO WARRANTY OR GUARANTEE GIVEN BY ANY PERSON, FIRM, OR CORPORATION WITH RESPECT TO THIS PRODUCT SHALL BE BINDING ON SAMSUNG. SAMSUNG SHALL NOT BE LIABLE FOR LOSS OF REVENUE OR PROFITS, FAILURE TO REALIZE SAVINGS OR OTHER BENEFITS, OR ANY OTHER SPECIAL, INCIDENTAL OR CONSEQUENTIAL DAMAGES CAUSED BY THE USE, MISUSE, OR INABILITY TO USE THIS PRODUCT, REGARDLESS OF THE LEGAL THEORY ON WHICH THE CLAIM IS BASED, AND EVEN IF SAMSUNG HAS BEEN ADVISED OF THE POSSIBILITY OF SUCH DAMAGES.

NOR SHALL RECOVERY OF ANY KIND AGAINST SAMSUNG BE GREATER IN AMOUNT THAN THE PURCHASE PRICE OF THE PRODUCT SOLD BY SAMSUNG AND CAUSING THE ALLEGED DAMAGE.

WITHOUT LIMITING THE FOREGOING, PURCHASER ASSUMES ALL RISK AND LIABILITY FOR LOSS, DAMAGE, OR INJURY TO PURCHASER AND PURCHASER'S PROPERTY AND TO OTHERS AND THEIR PROPERTY ARISING OUT OF THE USE, MISUSE, OR INABILITY TO USE THIS PRODUCT. THIS LIMITED WARRANTY SHALL NOT EXTEND TO ANYONE OTHER THAN THE ORIGINAL PURCHASER OF THIS PRODUCT, IS NONTRANSFERABLE AND STATES YOUR EXCLUSIVE REMEDY.

Some states do not allow limitations on how long an implied warranty lasts, or the exclusion or limitation of incidental or consequential damages, so the above limitations or exclusions may not apply to you. This warranty gives you specific rights, and you may also have other rights, which vary from state to state.

To obtain warranty service, please contact SAMSUNG at:

In USA

Samsung Electronics America, Inc.
85 Challenger Road
Ridgefield Park, NJ 07660
1-800-SAMSUNG (726-7864)
www.samsung.com/us/support

In CANADA

Samsung Electronics Canada Inc.
2050 Derry Road West
Mississauga, Ontario L5N 0B9 Canada
1-800-SAMSUNG (726-7864)
www.samsung.com/ca/support (English)
www.samsung.com/ca_fr/support (French)

memo

memo

memo

SAMSUNG



Scan the QR code* or visit www.samsung.com/spsn to view our helpful How-to Videos and Live Shows

*Requires reader to be installed on your smartphone

bit.ly/samsungdishwashers

Questions or Comments?

COUNTRY	CALL	OR VISIT US ONLINE AT
U.S.A	1-800-SAMSUNG (726-7864)	www.samsung.com/us/support
CANADA	1-800-SAMSUNG (726-7864)	www.samsung.com/ca/support (English) www.samsung.com/ca_fr/support (French)

SAMSUNG



Scan the QR code* or visit
www.samsung.com/spsn
to view our helpful
How-to Videos and Live Shows

*Requires reader to be installed on your smartphone

bit.ly/samsungdishwashers

Des questions ou des commentaires ?

PAYS	N° de téléphone	SITE INTERNET
U.S.A	1-800-SAMSUNG (726-7864)	www.samsung.com/us/support
CANADA	1-800-SAMSUNG (726-7864)	www.samsung.com/ca/support (English) www.samsung.com/ca_fr/support (French)

DD81-01825C-00