



Scan this with your smartphone

Scan the QR code\* or visit  
[www.samsung.com/spsn](http://www.samsung.com/spsn)  
to view our helpful  
How-to Videos and Live Shows

\*Requires reader to be installed on your  
smartphone

Please be advised that the Samsung warranty does NOT cover service calls to explain product operation, correct improper installation, or perform normal cleaning or maintenance.

#### QUESTIONS OR COMMENTS

COUNTRY	CALL	OR VISIT US ONLINE AT
U.S.A Consumer Electronics	1-800-SAMSUNG(726-7864)	<a href="http://www.samsung.com/us/support">www.samsung.com/us/support</a>
CANADA	1-800-SAMSUNG(726-7864)	<a href="http://www.samsung.com/ca/support">www.samsung.com/ca/support</a> (English) <a href="http://www.samsung.com/ca_fr/support">www.samsung.com/ca_fr/support</a> (French)

DE68-04366A-00

# Microwave Oven

---

## User manual

MS11J5023A\*

---



# Contents

---

<b>Important safety instructions</b>	<b>4</b>
<b>Installation</b>	<b>17</b>
Accessories	17
Installation site	18
Turntable	18
<b>Maintenance</b>	<b>19</b>
Cleaning	19
Replacement (repair)	20
Care against an extended period of disuse	20
<b>Quick look-up guide</b>	<b>21</b>
<b>Oven features</b>	<b>22</b>
Oven	22
Control panel	23
<b>Oven use</b>	<b>24</b>
How a microwave oven works	24
Checking that your oven is operating correctly	25
Cooking/Reheating	26
Setting the time	27
Power levels and time variations	28
Adjusting the cooking time	28
Stopping the cooking	29
Setting the energy save mode	29
Using the auto cook features	30
Using the healthy cooking features	32
Using the defrost features	34
Using the deodorization features	36
Using the child lock features	36
Switching the beeper off	37
Demonstration mode	37

---

<b>Cooking smart</b>	<b>38</b>
Microwave cooking guide	38
Reheating guide	41
Defrosting guide	43
Quick & Easy	44
<b>Cookware guide</b>	<b>45</b>
<b>Troubleshooting</b>	<b>47</b>
Troubleshooting	47
Information code	51
<b>Technical specifications</b>	<b>52</b>
<b>Warranty</b>	<b>53</b>
Samsung microwave oven	53

# Important safety instructions

---

Congratulations on your new Samsung microwave oven. This manual contains important information on the installation, use and care of your appliance. Please take time to read this manual to take full advantage of your microwave oven's many benefits and features.

## WHAT YOU NEED TO KNOW ABOUT SAFETY INSTRUCTIONS

---

Warnings and Important Safety Instructions in this manual do not cover all possible conditions and situations that may occur. It is your responsibility to use common sense, caution, and care when installing, maintaining, and operating your microwave oven.

## PRECAUTIONS TO AVOID POSSIBLE EXPOSURE TO EXCESSIVE MICROWAVE ENERGY

---

- A.** Do not attempt to operate this oven with the door open since open-door operation can result in harmful exposure to microwave energy. It is important not to defeat or tamper with the safety interlocks.
- B.** Do not place any object between the oven front face and the door or allow soil or cleaner residue to accumulate on the sealing surface.
- C.** Do not operate the oven if it is damaged. It is particularly important that the oven door close properly and that there is no damage to the:
  - 1.** Door (bent),
  - 2.** Hinges and latches, (broken or loosened),
  - 3.** Door seals and sealing surface.
- D.** The oven should not be adjusted or repaired by anyone except properly qualified service personnel.

**SAVE THESE INSTRUCTIONS**

---

# IMPORTANT SAFETY SYMBOLS AND PRECAUTIONS

---

What the icons and signs in this user manual mean:

 **WARNING**









Hazards or unsafe practices that may result in **severe personal injury or death**.

 **CAUTION**

Hazards or unsafe practices that may result in **minor personal injury or property damage**.

 **CAUTION**

To reduce the risk of fire, explosion, electric shock, or personal injury when using your microwave oven, follow these basic safety precautions.

- |   |                               |   |  |
|---|-------------------------------|---|--|
|   | Do NOT attempt.               |   | Unplug the power plug from the wall socket.                  |
|  | Do NOT disassemble.           |  | Make sure the machine is grounded to prevent electric shock. |
|  | Do NOT touch.                 |  | Call the service center for help.                            |
|  | Follow directions explicitly. |  | Note   |

**These warning signs are here to prevent injury to you and others. Please follow them explicitly. After reading this section, keep it in a safe place for future reference.**

**SAVE THESE INSTRUCTIONS**

# Important safety instructions

---

When using any electrical appliance, basic safety precautions should be followed, including the following:

## **⚠ WARNING**

---

To reduce risk of burns, electric shock, fire, personal injury or exposure to excessive microwave energy:

1. Read all safety instructions before using the appliance.
2. Read and follow the specific "Precautions to avoid possible exposure to excessive microwave energy" on page 4.
3. This appliance must be grounded. Connect only to properly grounded outlets. See Important "Grounding instructions" on page 8 of this manual.
4. Install or locate this appliance only in accordance with the provided installation instructions.
5. Some products such as whole eggs and sealed containers (for example, closed glass jars) can explode if heated rapidly. Never heat them in a microwave oven.
6. Use this appliance only for its intended use as described in the manual. Do not put corrosive chemicals or vapors in or on this appliance. This type of oven is specifically designed to heat, cook, or dry food. It is not designed for industrial or laboratory use.
7. As with any appliance, close supervision is necessary when it is used by children. Keep children away from the door when opening or closing it as they may bump themselves on the door or catch their fingers in the door.
8. Do not operate this appliance if it has a damaged cord or plug, if it is not working properly, or if it has been damaged or dropped.
9. This appliance should be repaired or serviced only by qualified service personnel. Contact the nearest authorized service facility for examination, repair, or adjustment.
10. Do not cover or block any openings on the appliance.
11. Do not tamper with or make any adjustments or repairs to the door.
12. Do not store this appliance outdoors. Do not use this product near water, for example, near a kitchen sink, in a wet basement, near a swimming pool, or similar locations.
13. Do not immerse the cord or plug in water.
14. Keep the cord away from heated surfaces. (including the back of the oven).
15. Do not let the cord hang over edge of table or counter.

## SAVE THESE INSTRUCTIONS

- 
- 16.** When cleaning surfaces of the door and oven that come together when the door closes, use only mild, nonabrasive soaps, or detergents applied with a sponge or soft cloth. Unplug the plug before cleaning.
  - 17.** To reduce the risk of fire in the oven cavity:
    - a.** Do not overcook food. Carefully attend appliance when paper, plastic, or other combustible materials are placed inside the oven to facilitate cooking.
    - b.** Remove wire twist-ties from paper or plastic bags before placing the bags in the oven.
    - c.** If materials inside the oven ignite, keep the oven door closed, turn the oven off, and disconnect the power cord, or shut off the power at the fuse or circuit breaker panel. If the door is opened, the fire may spread.
    - d.** Do not use the cavity for storage purposes. Do not leave paper products, cooking utensils, or food in the cavity when not in use.
  - 18.** Liquids, such as water, milk, coffee, or tea can be overheated beyond the boiling point without appearing to be boiling. Visible bubbling or boiling when the container is removed from the microwave oven is not always present. THIS COULD RESULT IN VERY HOT LIQUIDS SUDDENLY BOILING OVER WHEN THE CONTAINER IS DISTURBED OR A SPOON OR OTHER UTENSIL IS INSERTED INTO THE LIQUID. To reduce the risk of injury:
    - a.** Do not overheat liquid.
    - b.** Stir liquid both before and halfway through heating it.
    - c.** Do not use straight-sided containers with narrow necks.
    - d.** After heating, allow the container to stand in the microwave oven for a short time before removing the container.
    - e.** Use extreme care when inserting a spoon or other utensil into the container.
  - 19.** Oversized foods or oversized metal utensils should not be inserted in microwave / toaster oven as they may create a fire or electric shock.
  - 20.** Do not clean with metal scouring pads. Piece can burn off the pad and touch electrical parts involving a risk of electric shock.
  - 21.** Do not use paper products when appliance is operated in the toaster mode.
  - 22.** Do not store any materials, other than manufacturer's recommended accessories, in this oven when not in use.
  - 23.** Do not cover racks or any other part of the oven with metal foil. This will cause overheating of the oven.

**SAVE THESE INSTRUCTIONS**



# Important safety instructions

---

## CAUTION

---

1. Over The Range model Only
  - Clean Ventilating Hoods Frequently - Grease should not be allowed to accumulate on the hood of the filter.
  - When flaming foods under the hood, turn the fan on.
  - Use care when cleaning the vent-hood filter. Corrosive cleaning agents, such as lye-based oven cleaner, may damage the filter.
2. Push Button type model Only
  - Pre-caution for safe use to avoid possible exposure to excessive micro oven energy : Do not attempt to pull any part of the door by hand to open the door. Open the door only utilizing the push button located at front-right-bottom side.

## GROUNDING INSTRUCTIONS

---

This appliance must be grounded. In the event of an electrical short circuit, grounding reduces the risk of electric shock by providing an escape wire for the electrical current. This appliance is equipped with a cord that includes a grounding wire and a grounding plug. The plug must be plugged into an outlet that is properly installed and grounded.

## WARNING

---

Improper use of the grounding plug can result in a risk of electric shock.

- Plug into a grounded 3 prong outlet. Do not remove the third (grounding) prong. Do not use an adaptor or otherwise defeat the grounding plug.
- Consult a qualified electrician or service person if you do not understand the grounding instructions or if you are not sure if the appliance is properly grounded.
- We do not recommend using an extension cord with this appliance. If the power-supply cord is too short, have a qualified electrician or serviceman install an outlet near the appliance. However, if it is necessary to use an extension cord, read and follow the "Use of Extension Cords" section below.

## SAVE THESE INSTRUCTIONS

---

## USE OF EXTENSION CORDS

---

A short power-supply cord is provided to reduce the risk of your becoming entangled in or tripping over a longer cord. Longer cord sets or extension cords are available and you can use them if you exercise care. If you use a long cord or extension cord:

1. The marked electrical rating of the cord set or extension cord should be at least as great as the electrical rating of the appliance.
2. The extension cord must be a grounding-type 3-wire cord and it must be plugged into a 3-slot outlet.
3. The longer cord should be arranged so that it will not drape over the counter top or tabletop where it can be pulled on by children or tripped over accidentally. If you use an extension cord, the interior light may flicker and the speed of the blower may vary when the microwave oven is on. Cooking times may be longer too.

## ▲ CRITICAL INSTALLATION WARNINGS

---

- ★ The installation of this appliance must be performed by a qualified technician or service company.

- Failing to have a qualified technician install the oven may result in electric shock, fire, an explosion, problems with the product, or injury.

Unpack the oven, remove all packaging material and examine the oven for any damage such as dents on the interior or exterior of the oven, broken door latches, cracks in the door, or a door that is not lined up correctly. If there is any damage, do not operate the oven and notify your dealer immediately.

Make sure to install your oven in a location with adequate space.

Remove all foreign substances such as dust or water from the power plug terminals and contact points using a dry cloth on a regular basis.

- Unplug the power plug and clean it with a dry cloth.
- Failing to do so may result in electric shock or fire.

Plug the power cord into a properly grounded 3 pronged outlet. Your oven should be the only appliance connected to this circuit.

- Sharing a wall socket with other appliances, using a power strip, or extending the power cord may result in electric shock or fire.
- Do not use an electric transformer. It may result in electric shock or fire.
- Ensure that the voltage, frequency and current provided match the product's specifications. Failing to do so may result in electric shock or fire.

Keep all packaging materials out of the reach of children. Children may use them for play.

**SAVE THESE INSTRUCTIONS**

# Important safety instructions

---

 This appliance must be properly grounded. Read and follow the specific “Grounding instructions” found in the beginning of this Section. Do not ground the appliance to a gas pipe, plastic water pipe, or telephone line.

- This may result in electric shock, fire, an explosion, or problems with the product.
- Never plug the power cord into a socket that is not grounded correctly and make sure that it is grounded in accordance with local and national codes.

Do not cut or remove the third (ground) prong from the power cord under any circumstances.

Connect the oven to a 20A circuit. If you connect the oven to a 15A circuit, make sure that the circuit breaker is operable.

 Do not install this appliance in a humid, oily, or dusty location, or in a location exposed to direct sunlight or water (rain drops).

- This may result in electric shock or fire.

Plug the power plug into the wall socket firmly. Do not use a damaged power plug, damaged power cord, or loose wall socket.

- This may result in electric shock or fire.

Do not mount over a sink.

Do not pull or excessively bend the power cord.

Do not twist or tie the power cord.

Do not hook the power cord over a metal object, place a heavy object on the power cord, insert the power cord between objects, or push the power cord into the space behind the appliance.

- This may result in electric shock or fire.

Do not pull the power cord when you unplug the oven.

- Unplug the oven by pulling the plug only.
- Failing to do so may result in electric shock or fire.



 When the power plug or power cord is damaged, contact your nearest service center for a replacement or repair.

## SAVE THESE INSTRUCTIONS

---

## INSTALLATION CAUTIONS

---

-  Position the oven so that the plug is easily accessible.
  - Failing to do so may result in electric shock or fire due to electric leakage.
-  Unplug the oven when it is not being used for long periods of time or during a thunder/lightning storm.
  - Failing to do so may result in electric shock or fire.

## CRITICAL USAGE WARNINGS

---

-  If the microwave appliance is flooded, please contact your nearest service center. Failing to do so may result in electric shock or fire.

Read and follow the specific “Precautions to Avoid Possible Exposure to Excessive Microwave Energy”, found in the beginning of this Safety Information Section.

If the microwave generates a strange noise, a burning smell or smoke, unplug it immediately and contact your nearest service center.

- Failing to do so may result in electric shock or fire.

In the event of a gas leak (propane gas, LP gas, etc.), ventilate the room immediately. Do not touch the microwave, power cord, or plug.

- Do not use a ventilating fan.
- A spark may result in an explosion or fire.

Take care that the door or any of the other parts do not come into contact with your body while cooking or just after cooking.

- Failing to do so may result in burns.

In the event of a grease fire on the surface units below the oven, smother the flaming pan on the surface unit by covering the pan completely with a lid, a cookie sheet, or a flat tray.

Never leave surface units beneath your oven unattended at high heat settings. Boil overs cause smoking and greasy spillovers that may ignite and spread if the vent fan is operating. To minimize automatic fan operation, use adequate sized cookware and use high heat on surface units only when necessary.

If materials inside the oven should ignite, keep the oven door closed, turn the oven off and disconnect the power cord, or shut off power at the fuse or circuit breaker panel. If the door is opened, the fire may spread.

- Always observe Safety Precautions when using your oven. Never try to repair the oven on your own. There is dangerous voltage inside. If the oven needs to be repaired, contact an authorized service center near you.

## SAVE THESE INSTRUCTIONS

# Important safety instructions

-  Do not attempt to repair, disassemble, or modify the appliance yourself.
  - Because a high voltage current enters the product chassis during operation, opening the chassis can result in electric shock or fire.
  - You may be exposed to electromagnetic waves.
  - When the oven requires repair, contact your nearest service center.

-  If any foreign substance such as water enters the microwave, unplug it and contact your nearest service center.

- Failing to do so may result in electric shock or fire.

-  Do not touch the power plug with wet hands.

- This may result in electric shock.

Do not turn the appliance off by unplugging the power plug while the appliance is in operation.

- Plugging the power plug into the wall socket again may cause a spark and result in electric shock or fire.

Keep all packaging materials well out of the reach of children. Packaging materials can be dangerous to children.

- If a child places a bag over its head, the child can suffocate.

Do not let children or any person with reduced physical, sensory or mental capabilities use this appliance unsupervised. Make sure that the appliance is out of the reach of children.

- Failing to do so may result in electric shock, burns or injury.

Do not touch the inside of the appliance immediately after cooking. The inside of the appliance will be hot.

- The heat on the inside of the oven can cause burns.

Do not put aluminum foil (except as specifically directed in this manual), metal objects (such as containers, forks, etc.) or containers with golden or silver rims into the microwave.

- These objects can cause sparks or a fire.

Do not use or place flammable sprays or objects near the oven.

- Heat from the microwave can cause flammable sprays to explode or burn.

- Failing to do so may result in electric shock or injury.

Do not tamper with or make any adjustments or repairs to the door. Under no circumstances should you remove the outer cabinet.



Do not store or use the oven outdoors.

## SAVE THESE INSTRUCTIONS

---

## USAGE CAUTIONS

---

-  If the surface of the microwave is cracked, turn it off.
- Failing to do so may result in electric shock.
- Dishes and containers can become hot. Handle with care.
- Hot foods and steam can cause burns. Carefully remove container coverings, directing steam away from your hands and face.
- Remove lids from baby food before heating. After heating baby food, stir well to distribute the heat evenly. Always test the temperature by tasting before feeding the baby. The glass jar or surface of the food may appear to be cooler than the food in the interior, which can be so hot that it will burn the infant's mouth.
- Make sure all cookware used in the oven is suitable for microwaving.
- Use microwavable cookware in strict compliance with such manufacturer's recommendations.
-  Do not stand on top of the microwave or place objects (such as laundry, oven covers, lighted candles, lighted cigarettes, dishes, chemicals, metal objects, etc.) on the appliance.
- Items, such as a cloth, may get caught in the door.
  - This may result in electric shock, fire, problems with the product, or injury.
- Do not operate the appliance with wet hands.
- This may result in electric shock.
- Do not spray volatile material such as insecticide onto the surface of the appliance.
- As well as being harmful to humans, it may also result in electric shock, fire or problems with the product.
- Do not place the appliance over a fragile object such as a sink or glass object.
- This may result in damage to the sink or glass object.
- Do not put your face or body close to the appliance while cooking or when opening the door just after cooking.
- Take care that children do not come too close to the appliance.
  - Failing to do so may result in children burning themselves.
- Do not place food or heavy objects over the door when opening the door.
- The food or object may fall and this may result in burns or injury.
- Do not abruptly cool the door, the inside of the appliance, or the dish by pouring water over it during or just after cooking.
- This may result in damage to the appliance. The steam or water spray may result in burns or injury.

**SAVE THESE INSTRUCTIONS**

# Important safety instructions

---

- ❑ Do not cook without the glass tray in place on the oven floor. Food will not cook properly without the tray.

Do not defrost frozen beverages in narrow-necked bottles. The containers can break.

Do not scratch the glass of the oven door with a sharp object.

- This may result in the glass being damaged or broken.

Do not store anything directly on top of the appliance when it is in operation.

Do not use sealed containers. Remove seals and lids before use. Sealed containers can explode due to buildup of pressure even after the oven has been turned off.

## **⚠ CRITICAL CLEANING INSTRUCTIONS**

---

Do not clean the appliance by spraying water directly onto it.

Do not use benzene, thinner, or alcohol to clean the appliance.

- This may result in discoloration, deformation, damage, electric shock, or fire.

Before cleaning or performing maintenance, unplug the appliance from the wall socket and remove food waste from the door and cooking compartment.

- Failing to do so may result in electric shock or fire.

Take care not to hurt yourself when cleaning the appliance.

(external/internal)

- You may hurt yourself on the sharp edges of the appliance.

Do not clean the appliance with a steam cleaner.

- This may result in corrosion.

Keep the inside of the oven clean. Food particles or spattered oils stuck to the oven walls or floor can cause paint damage and reduce the efficiency of the oven.

## SAVE THESE INSTRUCTIONS

## INSTALLING YOUR MICROWAVE OVEN

Place the oven on a flat level surface 85 cm above the floor. The surface should be strong enough to safely bear the weight of the oven.

### NOT FOR BUILT-IN INSTALLATION

- When you install your oven, make sure there is adequate ventilation for your oven by leaving at least 10 cm (4 inches) of space behind and, on the sides of the oven and 20 cm (8 inches) of space above.
  - Remove all packing materials inside the oven.
  - Install the roller ring and turntable. Check that the turntable rotates freely. (Turntable type model only)
  - This microwave oven has to be positioned so that plug is accessible.
- If the supply cord is damaged, it must be replaced by the manufacturer, its service agent or similarly qualified persons in order to avoid a hazard. For your personal safety, plug the cable into a proper AC earthed socket.
  - Do not install the microwave oven in hot or damp surroundings like next to a traditional oven or radiator. The power supply specifications of the oven must be respected and any extension cable used must be of the same standard as the power cable supplied with the oven. Wipe the interior and the door seal with a damp cloth before using your microwave oven for the first time.

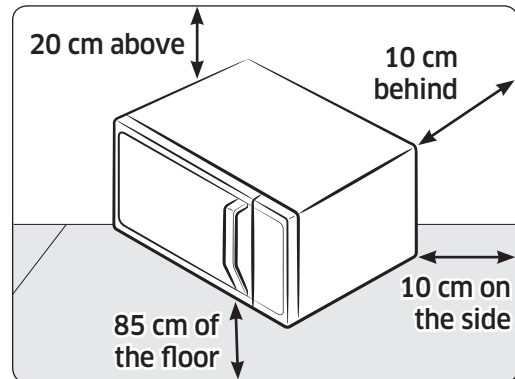

## CLEANING THE TURNTABLE AND ROLLER RINGS

Clean the roller rings periodically and wash the turntable as required. You can wash the turntable safely in your dishwasher.

**SAVE THESE INSTRUCTIONS**



# Important safety instructions

---

## STORING AND REPAIRING YOUR MICROWAVE OVEN

---

If you need to store your microwave oven for a short or extended period of time, choose a dust-free, dry location. Dust and dampness may adversely affect the microwave parts.

- ⚠ • Do not repair, replace or service any part of your microwave oven yourself. Allow only a qualified service technician to perform repairs. If the oven is faulty and needs servicing, or you are in doubt about its condition, unplug the oven from the power outlet and contact your nearest service center.
- Do not use the oven if it is damaged, in particular, if the door or door seals are damaged. Door damage includes a broken hinge, a worn out seal, or distorted/bent casing.
- Do not remove the oven from its casing.
- This microwave oven is for home use only and is not intended for commercial use.

**SAVE THESE INSTRUCTIONS**

# Installation

## Accessories

Depending on the model that you have purchased, you are supplied with several accessories that can be used in a variety of ways.

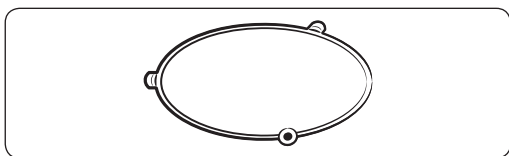

**01 \*Roller ring**, to be placed in the centre of the oven.

**Purpose:** The roller ring supports the turntable.

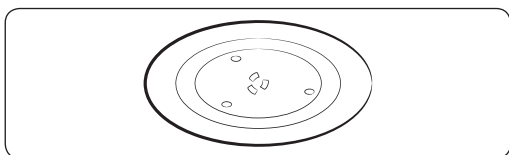

**02 \*Turntable**, to be placed on the roller ring with the centre fitting to the coupler.

**Purpose:** The turntable serves as the main cooking surface; it can be easily removed for cleaning.

### 👉 IMPORTANT

**DO NOT** operate the microwave oven without the roller ring and turntable.

### 👉 IMPORTANT

**If you need an accessory marked with a \*, you can buy it from the Samsung Contact Center (1-800-726-7864) or on-line at: (www.samsungparts.com)**

# Installation

## Installation site

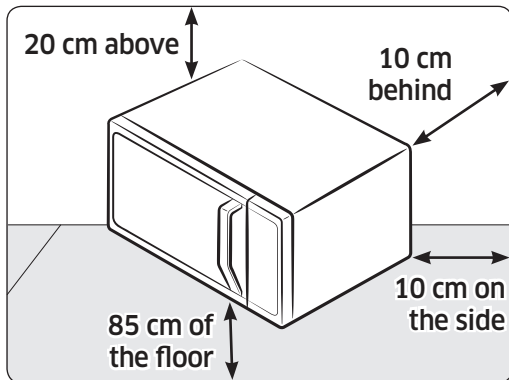

- Select a flat, level surface approx. 85 cm above the floor. The surface must support the weight of the oven.
- Secure room for ventilation, at least 10 cm from the rear wall and both sides, and 20 cm from above.
- Do not install the oven in hot or damp surroundings, such as next to other microwave ovens or radiators.
- Conform to the power supply specifications of this oven. Use only approved extension cables if you need to use.
- Wipe the interior and the door seal with a damp cloth before using your oven for the first time.

## Turntable

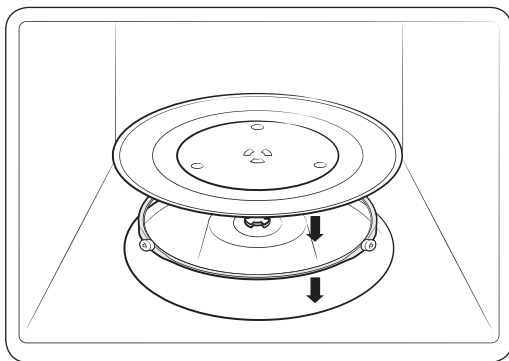

Remove all packing materials inside the oven. Install the roller ring and turntable. Check that the turntable rotates freely.

# Maintenance

---

## Cleaning

---

Clean the oven regularly to prevent impurities from building up on or inside the oven. Also pay special attention to the door, door sealing, and turntable and roller ring (applicable models only).

If the door won't open or close smoothly, first check if the door seals have built up impurities. Use a soft cloth in soapy water to clean both the inner and outer sides of the oven. Rinse and dry well.

### To remove stubborn impurities with bad smells from inside the oven

- 1.** With an empty oven, put a cup of diluted lemon juice on the centre of the turntable.
- 2.** Heat the oven for 10 minutes at max power.
- 3.** When the cycle is complete, wait until the oven cools down. Then, open the door and clean the cooking chamber.

### To clean inside swing-heater models

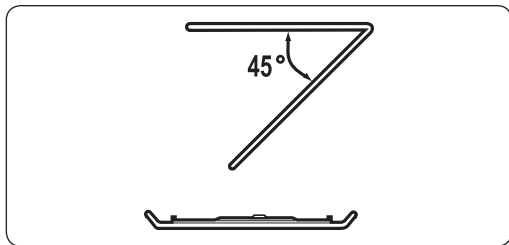

To clean the upper area of the cooking chamber, lower the top heating element by 45° as shown. This will help clean the upper area. When done, reposition the top heating element.

# Maintenance

---

## **⚠ CAUTION**

- Keep the door and door sealing clean and ensure the door opens and closes smoothly. Otherwise, the oven's lifecycle may be shortened.
- Take caution not to spill water into the oven vents.
- Do not use any abrasive or chemical substances for cleaning.
- After each use of the oven, use a mild detergent to clean the cooking chamber after waiting for the oven to cool down.

## **Replacement (repair)**

---

## **⚠ WARNING**

This oven has no user-removable parts inside. Do not try to replace or repair the oven yourself.

- If you encounter a problem with hinges, sealing, and/or the door, contact a qualified technician or a local Samsung service centre for technical assistance.
- If you want to replace the light bulb, contact a local Samsung service centre. Do not replace it yourself.
- If you encounter a problem with the outer housing of the oven, first unplug the power cord from the power source, and then contact a local Samsung service centre.

## **Care against an extended period of disuse**

---

- If you don't use the oven for an extended period of time, unplug the power cord and move the oven to a dry, dust-free location. Dust and moisture that builds up inside the oven may affect the performance of the oven.

# Quick look-up guide

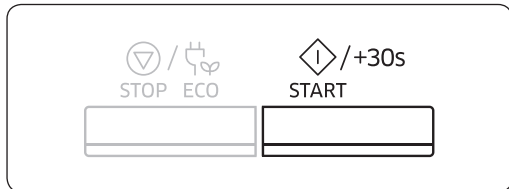

## If you want to cook some food.

Place the food in the oven. Press the **START/+30s** button.

**Result:** Cooking starts. When it has finished.

- 1) The oven beeps 4 times.
- 2) The end reminder signal will beep 3 times (once every minute).
- 3) The current time is displayed again.

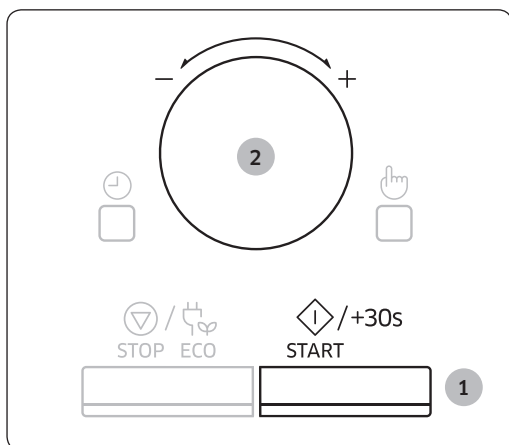

## If you want to add an extra 30 seconds.

1. Press the **START/+30s** button one or more times for each extra 30 seconds that you wish to add.
2. By turning the **Dial Knob**, You can set the time as you want.

# Oven features

## Oven

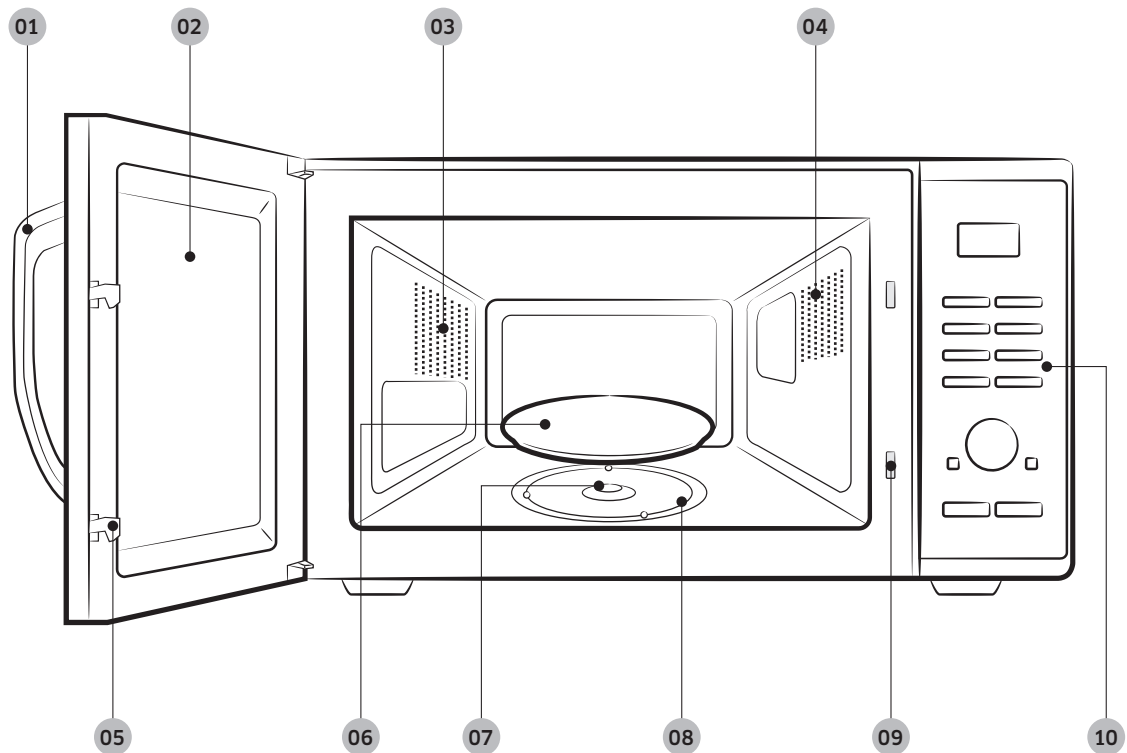

Oven features

- |                             |                        |                                  |
|-----------------------------|------------------------|----------------------------------|
| <b>01</b> Door handle       | <b>04</b> Light        | <b>07</b> Coupler                |
| <b>02</b> Door              | <b>05</b> Door latches | <b>08</b> Roller ring            |
| <b>03</b> Ventilation holes | <b>06</b> Turntable    | <b>09</b> Safety interlock holes |
|                             |                        | <b>10</b> Control panel          |

## Control panel

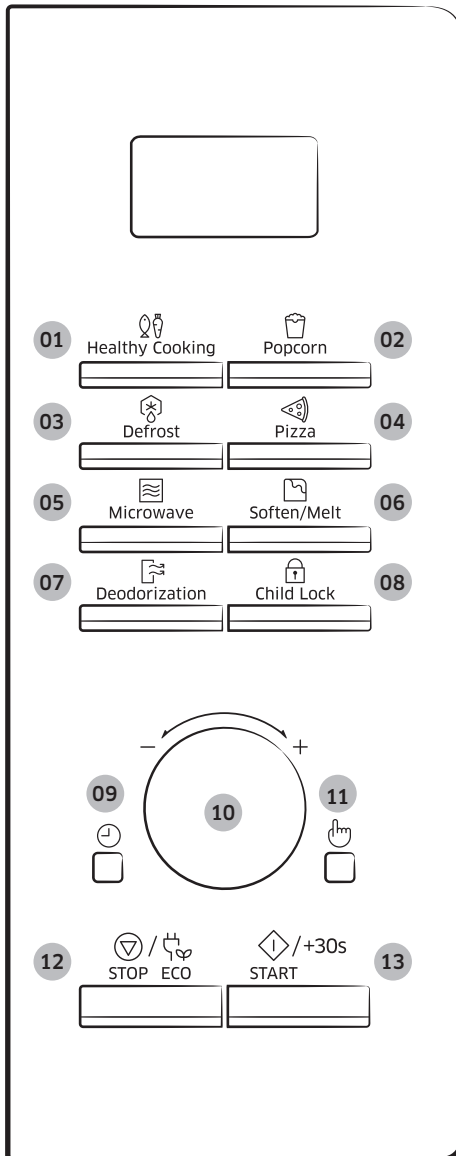

- 01** Healthy Cooking Button
- 02** Popcorn Button
- 03** Defrost Button
- 04** Pizza Button
- 05** Microwave Button
- 06** Soften/Melt Button
- 07** Deodorization Button
- 08** Child Lock Button
- 09** Clock Button
- 10** Dial Knob (Weight/Serving/Time)
- 11** Select Button
- 12** Stop/Eco Button
- 13** Start/+30s Button



# Oven use

## How a microwave oven works

Microwaves are high-frequency electromagnetic waves; the energy released enables food to be cooked or reheated without changing either the form or the colour.

You can use your microwave oven to:

- Defrost
- Reheat
- Cook

Cooking principle.

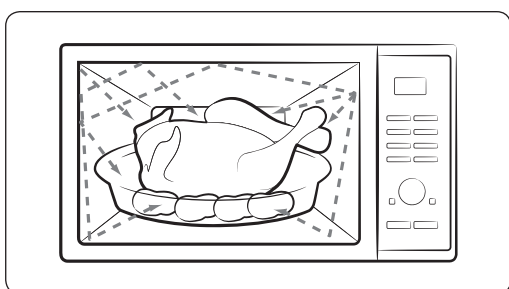

1. The microwaves generated by the magnetron reflected at cavity and are distributed uniformly as the food rotates on the turntable. The food is thus cooked evenly.
2. The microwaves are absorbed by the food up to a depth of about 1 inch (2.5 cm). Cooking then continues as the heat is dissipated within the food.
3. Cooking times vary according to the container used and the properties of the food:
  - Quantity and density
  - Water content
  - Initial temperature (refrigerated or not)

### IMPORTANT

As the centre of the food is cooked by heat dissipation, cooking continues even when you have taken the food out of the oven. Standing times specified in recipes and in this booklet must therefore be respected to ensure:

- Even cooking of the food right to the centre.
- The same temperature throughout the food.

---

## Checking that your oven is operating correctly

---

The following simple procedure enables you to check that your oven is working correctly at all times. If you are in doubt, refer to the section entitled “Troubleshooting” on the pages 47 to 51.

### NOTE

The oven must be plugged into an appropriate wall socket. The turntable must be in position in the oven. If a power level other than the maximum (100 % - 900 W) is used, the water takes longer to boil.

Open the oven door by pulling the handle on the right side of the door.  
Place a glass of water on the turntable.  
Close the door.

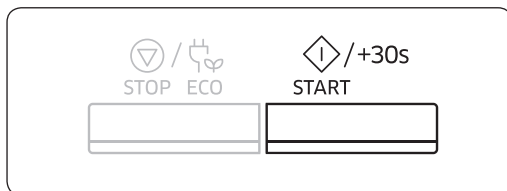

Press the **START/+30s** button and set the time to 4 or 5 minutes, by pressing the **START/+30s** button the appropriate number of times.

**Result:** The oven heats the water for 4 or 5 minutes.  
The water should then be boiling.

# Oven use

## Cooking/Reheating

The following procedure explains how to cook or reheat food.

### 👉 IMPORTANT

ALWAYS check your cooking settings before leaving the oven unattended.

Open the door. Place the food in the centre of the turntable. Close the door. Never switch the microwave oven on when it is empty.

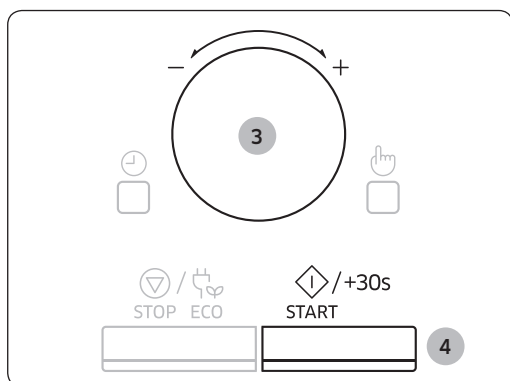
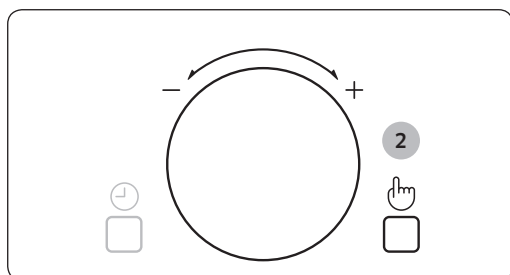
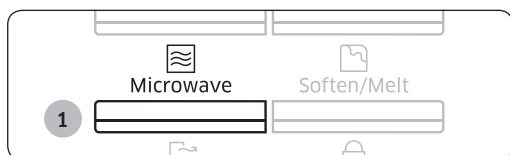

1. Press the **Microwave** button.  
**Result:** The 100 % (Maximum cooking power) indications are displayed:
2. Select the appropriate power level by turning the **Dial Knob**. (Refer to the power level table.)  
And then press the **Select** button.
3. Set the cooking time by turning the **Dial Knob**.  
**Result:** The cooking time is displayed.
4. Press the **START/+30s** button.  
**Result:** The oven light comes on and the turntable starts rotating. Cooking starts and when it has finished.
  - 1) The oven beeps 4 times.
  - 2) The end reminder signal will beep 3 times (once every minute).
  - 3) The current time is displayed again.

---

## Setting the time

---

When power is supplied, “88:88” and then “12:00” is automatically displayed on the display. Please set the current time. The time can be displayed in either the 24-hour or 12-hour notation. You must set the clock:

- When you first install your microwave oven
- After a power failure

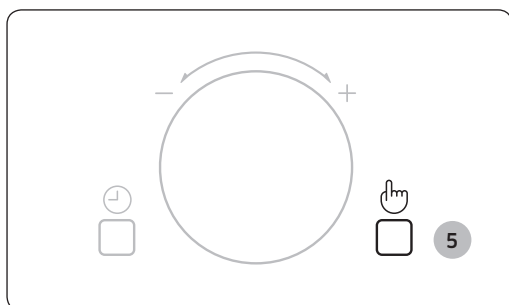
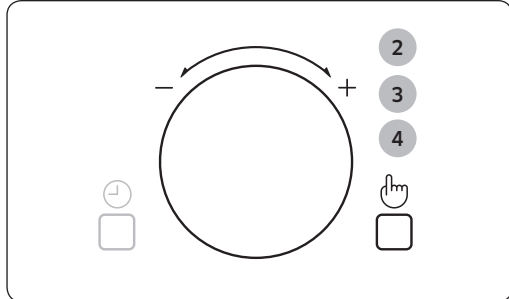
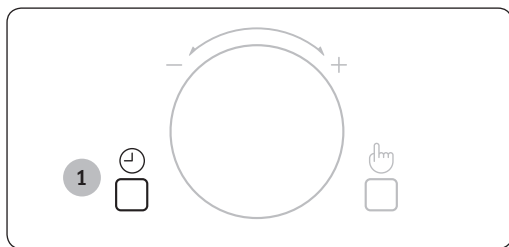

### NOTE

Do not forget to reset the clock when you switch to and from summer and winter time.

1. Press the **Clock** button.
2. Set the 24-hour or 12-hour notation by turning the **Dial Knob**. And then press the **Select** button.
3. Turn the **Dial Knob** to set the hour. And then press the **Select** button.
4. Turn the **Dial Knob** to set the minute.
5. When the right time is displayed, press the **Select** button to start the clock.  
**Result:** The time is displayed whenever you are not using the microwave oven.

# Oven use

## Power levels and time variations

The power level function enables you to adapt the amount of energy dissipated and thus the time required to cook or reheat your food, according to its type and quantity. You can choose between ten power levels.

Power level	Percentage
Warm	10 %
Defrost	20 %
Low	30 %
Medium low	40 %
Medium	50 %
Simmer	60 %
Medium high	70 %

Power level	Percentage
Reheat	80 %
Saute	90 %
High	100 %

The cooking times given in recipes and in this booklet correspond to the specific power level indicated.

If you select a...	Then the cooking time must be...
Higher power level	Decreased
Lower power level	Increased

## Adjusting the cooking time

You can increase the cooking time by pressing the **START/+30s** button once for each 30 seconds to be added.

- Check how cooking is progressing at any time simply by opening the door
- Increase the remaining cooking time

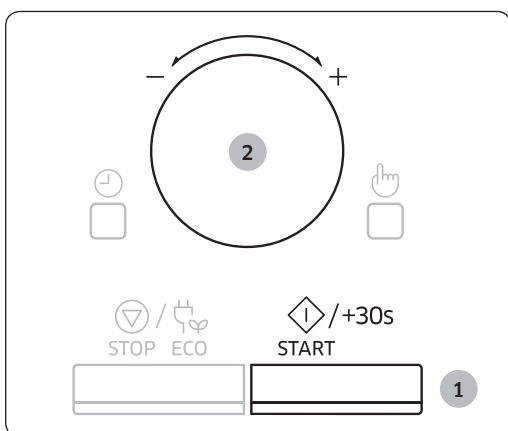

### Method 1.

To increase the cooking time of your food during cooking, press the **START/+30s** button once for each 30 seconds that you wish to add.

- Example: To add three minutes, press the **START/+30s** button six times.

### Method 2.

Just turning **Dial Knob** to adjust cooking time.

- To increase cooking time, turn to right and to decrease cooking time, turn to left.

## Stopping the cooking

You can stop cooking at any time so that you can:

- Check the food
- Turn the food over or stir it
- Leave it to stand

To stop the cooking...	Then...
Temporarily	Temporarily : Open the door or press the <b>STOP/ECO</b> button once. <b>Result:</b> Cooking stops. To resume cooking, close the door again and press the <b>START/+30s</b> button.
Completely	Completely : Press the <b>STOP/ECO</b> button once. <b>Result:</b> Cooking stops. If you wish to cancel the cooking settings, press the <b>STOP/ECO</b> button again.

## Setting the energy save mode

The oven has an energy save mode.



- Press the **STOP/ECO** button.  
**Result:** Display off.
- To remove energy save mode, open the door or press the **STOP/ECO** button and then display shows current time. The oven is ready for use.

### NOTE

#### Auto energy saving function

If you do not select any function when appliance is in the middle of setting or operating with temporary stop condition, function is canceled and clock will be displayed after 25 minutes. Oven Lamp will be turned off after 5 minutes with door open condition.

# Oven use

## Using the auto cook features

You do not need to set either the cooking times or the power level.

You can adjust the size of the serving by turning the **Dial Knob**.

### **IMPORTANT**

Use only recipients that are microwave-safe.

First, place the food in the centre of the turntable and close the door.

**1.** Press the **Popcorn, Pizza** or **Soften/Melt** button.

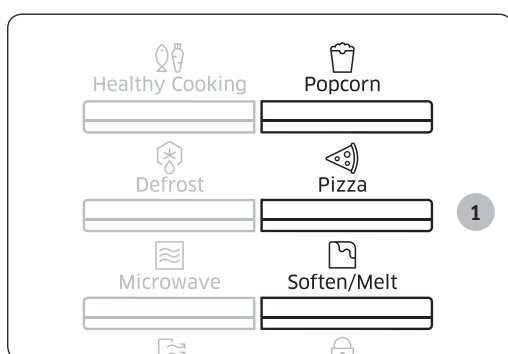

**2.** Select the type of food or serving size that you are cooking by turning the **Dial Knob**. (Refer to the table on the side.)

**3.** Press the **START/+30s** button.

**Result:** The food is cooked according to the pre-programmed setting selected.

- 1) The oven beeps 4 times.
- 2) The end reminder signal will beep 3 times (once every minute).
- 3) The current time is displayed again.

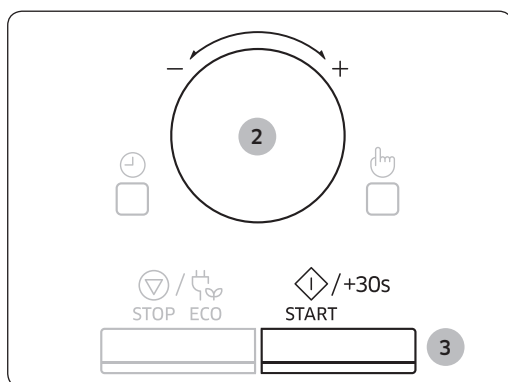

---

## IMPORTANT

Use oven gloves when taking out food.

### Popcorn

Code/Food	Serving Size	Instructions
1 Popcorn	3(85 g)	Use only one microwave popcorn bag at a time. Be careful when removing the heated bag from the oven and opening it.
2 Popcorn	3.5(100 g)	

### Pizza

Code/Food	Serving Size	Instructions
1 Pizza	1 Slice	Place 1-4 pizza slices on a microwave-safe plate with the wide ends of the slices towards the outside edge of the plate. Do not let the slices overlap. Do not cover.
2 Pizza	2 Slices	
3 Pizza	3 Slices	
4 Pizza	4 Slices	

### Soften/Melt

Code/Food	Serving Size	Instructions
1 Melt Butter	1 stick	Remove the wrapping, and then cut the butter in half vertically. Place the butter in a dish and cover with wax paper. Stir well after finishing and let stand for 1-2 minutes.
2 Melt Butter	2 sticks	
3 Melt chocolate	1 cup chips or 1 square	Place the chocolate chips or squares in a microwave-safe container. When the oven beeps, stir the chocolate, and then restart the oven. Stir and let stand for 1 minute.
4 Soften butter	1 stick (¼ lbs.)	Remove the wrapping, and then and cut butter in half vertically. Place butter in dish, cover with wax paper.
5 Soften cream cheese	1 Package (8 oz.)	Unwrap the cream cheese, and then place in a microwave-safe container. Cut in half vertically. Let stand for 2 minutes.



# Oven use

## Using the healthy cooking features

The cooking time and temperature will be adjusted according to the selected recipe.

### 👉 IMPORTANT

Use only recipients that are microwave-safe.

First, place the food in the centre of the turntable and close the door.



1. Press the **Healthy Cooking** button.

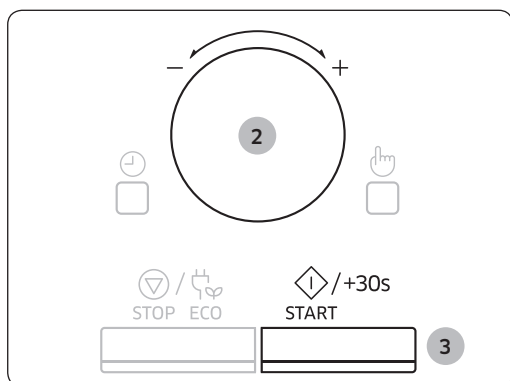

2. Select the type of food that you are cooking by turning the **Dial Knob**. (Refer to the table on the side.)

3. Press the **START/+30s** button.

**Result:** The food is cooked according to the pre-programmed setting selected.

- 1) The oven beeps 4 times.
- 2) The end reminder signal will beep 3 times (once every minute).
- 3) The current time is displayed again.

The table contains food quantities, weight ranges, and appropriate recommendations. Cooking modes and times have been pre-programmed for your convenience.

**🔑 IMPORTANT**

Use oven gloves when taking out food.

Code/Food	Serving Size	Instructions
1 Broccoli	250 g	Rinse and clean fresh broccoli and prepare florets. Put them evenly into a glass bowl with lid. Add 30 ml (2 tbsp) water. Put bowl in the centre of turntable. Cook covered. Stir after cooking. Stand for 1-2 minutes.
2 Carrots	250 g	Rinse and clean carrots and prepare even slices. Put them evenly into a glass bowl with lid. Add 30 ml (2 tbsp) water. Put bowl in the centre of turntable. Cook covered. Stir after cooking. Stand for 1-2 minutes.
3 Green Beans	250 g	Rinse and clean green beans. Put them evenly into a glass bowl with lid. Add 30 ml (2 tbsp) water. Put bowl in the centre of turntable. Cook covered. Stir after cooking. Stand for 1-2 minutes.
4 Spinach	150 g	Rinse and clean spinach. Put into a glass bowl with lid. Do not add water. Put bowl in the centre of turntable. Cook covered. Stir after cooking. Stand for 1-2 minutes.
5 Corn on the Cob	500 g	Rinse and clean corn on the cobs and put into an oval glass dish. Cover with microwave cling film and pierce film. Stand for 1-2 minutes.
6 Peeled Potatoes	250 g	Wash and peel the potatoes and cut into a similar size. Put them into a glass bowl with lid. Add 45-60 ml (3-4 tbsp) water. Put bowl in the centre of turntable. Cook covered. Stand for 2-3 minutes.
7 Brown Rice	250 g	Use a large glass ovenware dish with lid. Add double quantity of cold water (500 ml). Cook covered. Stir before standing time and add salt and herbs. Stand for 5-10 minutes.
8 Wholemeal Macaroni	250 g	Use a large glass ovenware dish with lid. Add 1 L hot boiling water, a pinch of salt and stir well. Cook covered. Stir before standing time and drain thoroughly afterwards. Stand for 1 minutes.
9 Quinoa	250 g	Use a large glass ovenware dish with lid. Add double quantity of cold water (500 ml). Cook covered. Stir before standing time and add salt and herbs. Stand for 1-3 minutes.
10 Bulgur	250 g	Use a large glass ovenware dish with lid. Add double quantity of cold water (500 ml). Cook covered. Stir before standing time and add salt and herbs. Stand for 2-5 minutes.

# Oven use

## Using the defrost features

This is useful to defrost frozen meat. The operating time and power level will be adjusted according to the selected programme.

### NOTE

Use only containers that are microwave-safe.

Open the door. Place the frozen food on a ceramic in the centre of the turntable. Close the door.

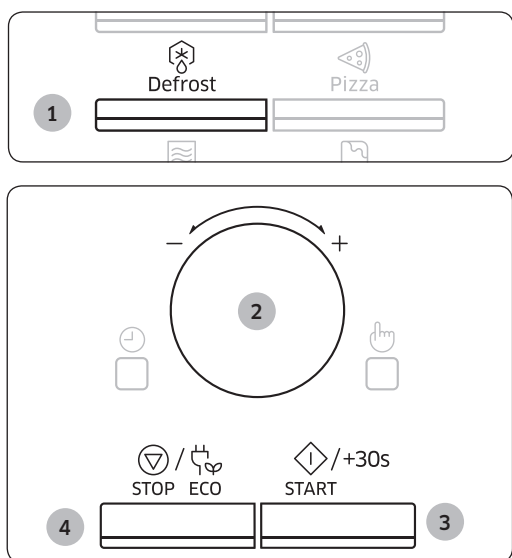

1. Press the **Defrost** button.

2. Select the size of the serving by turning the **Dial Knob**. (Refer to the table on the side.)

3. Press the **START/+30s** button.

#### **Result:**

- Defrosting begins.
- The oven beeps through defrosting to remind you to turn the food over.

4. Press the **STOP/ECO** button to finish defrosting.

#### **Result:**

- 1) The oven beeps 4 times.
- 2) The end reminder signal will beep 3 times (once every minute).
- 3) The current time is displayed again.

The table contains food quantities, weight ranges, and appropriate recommendations.

Food	Serving Size	Instructions
Roast Beef, Pork	2.5-3.5 lbs.	Start with the food placed fat side down. After each stage, turn the food over and shield any warm portions with narrow strips of aluminum foil. Let stand, covered for 10-20 minutes.
Steaks, Chops, Fish	0.5-3.5 lbs.	After each stage, rearrange the food. If there are any warm or thawed portions of food, shield them with narrow, flat pieces of aluminum foil. Remove any pieces of food that are nearly defrosted. Let stand, covered for 5-10 minutes.
Ground Meat	0.5-3.5 lbs.	After each stage, remove any pieces of food that are nearly defrosted. Let stand, covered with foil for 5-10 minutes.
Whole Chicken	2.5-3.5 lbs.	Remove giblets before frozen poultry. Start defrosting with the breast side down. After the first stage, turn the chicken over and shield any warm portions with narrow strips of aluminum foil. After the second stage, again shield any warm portions with narrow strips of aluminum foil. Let stand, covered for 30-60 minutes in the refrigerator.
Chicken Pieces	0.5-3.5 lbs.	After each stage, rearrange or remove any pieces of food that are nearly defrosted. Let stand for 10-20 minutes.

# Oven use

## Using the deodorization features

Use this features after cooking odorous food or when there is a lot of smoke in the oven interior.

First clean the oven interior.

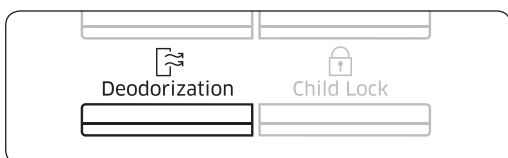

Press the **Deodorization** button after you have finished cleaning. As soon as you press the **Deodorization** button, the operation will start automatically. when it has finished, the oven beeps four times.

### NOTE

The deodorization time has been specified as 5 minutes. It increases by 30 seconds whenever the **START/+30s** button is pressed.

### NOTE

The maximum deodorization time is 15 minutes.

## Using the child lock features

Your microwave oven is fitted with a special child lock programme, which enables the oven to be “locked” so that children or anyone unfamiliar with it cannot operate it accidentally.

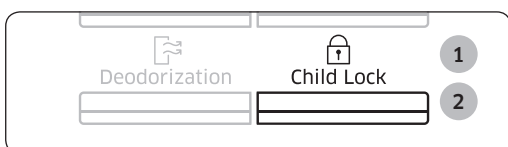

1. Press the **Child Lock** button at the 3 second.

### **Result:**

- The oven is locked (no functions can be selected).
- The display shows “L”.

L

2. To unlock the oven, press the **Child Lock** button at the 3 second.

**Result:** The oven can be used normally.

---

## Switching the beeper off

---

You can switch the beeper off whenever you want.

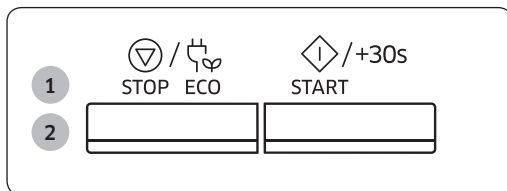

1. Press the **START/+30s** and **STOP/ECO** button at the same time.  
**Result:** The oven does not beep to indicate the end of a function.
2. To switch the beeper back on, press the **START/+30s** and **STOP/ECO** button again at the same time.  
**Result:** The oven operates normally.

---

## Demonstration mode

---

You can use the demonstration mode to see how your microwave oven operates without the oven heating.

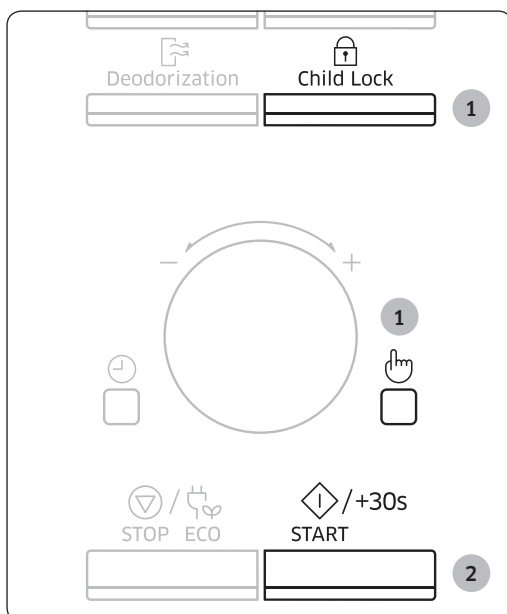

1. Press hidden button during 1 second. (the **Select** button + **Child Lock** button).  
**Result:** The display shows "On".
2. Press the **START/+30s** button.  
Now Demonstration mode is on.

### NOTE

To turn demo mode off, repeat 1-2 step. It will be displayed "OFF".

# Cooking smart

We provide these cooking guides to help you make the most out of this oven. Experience our cooking know-how to add convenience and richness to your life.

## Microwave cooking guide

- Cover the food throughout the entire cooking. The vaporised moisture from the food circles through inside and helps cook evenly.
  - When cooking is complete, let stand for the specified time. This allows the food to even out inside.
  - Use only microwave-safe cookware.
  - Stir twice during cooking and once after cooking, and then add seasoning to your preference.
- Frozen vegetables**
- Use a suitable glass Pyrex container with a lid.

Food	Serving Size (g)	Power	Time (min.)
Spinach	150	60 %	5-6
	Add 15 ml (1 tbsp) cold water. Stand for 2-3 minutes.		
Broccoli	300	60 %	8-9
	Add 30 ml (2 tbsp) cold water. Stand for 2-3 minutes.		
Peas	300	60 %	7-8
	Add 15 ml (1 tbsp) cold water. Stand for 2-3 minutes.		
Green Beans	300	60 %	7½-8½
	Add 30 ml (2 tbsp) cold water. Stand for 2-3 minutes.		
Mixed Vegetables (Carrots/Peas/Corn)	300	60 %	7-8
	Add 15 ml (1 tbsp) cold water. Stand for 2-3 minutes.		
Mixed Vegetables (Chinese style)	300	60 %	7½-8½
	Add 15 ml (1 tbsp) cold water. Stand for 2-3 minutes.		

## Fresh vegetables

- Use a suitable glass Pyrex container with a lid.
- Cut ingredients into as small pieces as possible to reduce the cooking time.
- Add 30-45 ml of cold water to every 250 g unless otherwise specified.
- Stir once during cooking and once after cooking, and then add seasoning to your preference.

Food	Serving Size (g)	Power	Time (min.)
Broccoli	250 500	90 %	4½-5 7-8
	Prepare even sized florets. Arrange the stems to the centre. Stand for 3 minutes.		
Brussels Sprouts	250	90 %	6-6½
	Add 60-75 ml (4-5 tbsp) water. Stand for 3 minutes.		
Carrots	250	90 %	4½-5
	Cut carrots into even sized slices. Stand for 3 minutes.		
Cauliflower	250 500	90 %	5-5½ 7½-8½
	Prepare even sized florets. Cut big florets into halves. Arrange stems to the centre. Stand for 3 minutes.		
Courgettes	250	90 %	4-4½
	Cut courgettes into slices. Add 30 ml (2 tbsp) water or a knob of butter. Cook until just tender. Stand for 3 minutes.		
Egg plants	250	90 %	3½-4
	Cut egg plants into small slices and sprinkle with 1 tbsp lemon juice. Stand for 3 minutes.		
Leeks	250	90 %	4-4½
	Cut leeks into thick slices. Stand for 3 minutes.		
Mushrooms	125 250	90 %	1½-2 2½-3
	Prepare small whole or sliced mushrooms. Do not add any water. Sprinkle with lemon juice. Spice with salt and pepper. Drain before serving. Stand for 3 minutes.		



# Cooking smart

Food	Serving Size (g)	Power	Time (min.)
Onions	250	90 %	5-5½
	Cut onions into slices or halves. Add only 15 ml (1 tbsp) water. Stand for 3 minutes.		
Pepper	250	90 %	4½-5
	Cut pepper into small slices. Stand for 3 minutes.		
Potatoes	250	90 %	4-5
	500		7-8
	Weigh the peeled potatoes and cut them into similar sized halves or quarters. Stand for 3 minutes.		
Turnip Cabbage	250	90 %	5½-6
	Cut turnip cabbage into small cubes. Stand for 3 minutes.		

## Rice and pasta

### Rice

- Use a large-sized glass Pyrex container with a lid. Note that rice doubles in volume during cooking.

### Pasta

- Use a large-sized glass Pyrex container. Cook uncovered.
- Add boiling water and a little salt, and stir well. Stir several times during and after cooking.
- Cover with a lid while letting stand, and then drain well.

Food	Serving Size	Power	Time (min.)
White Rice (Parboiled)	250 g	90 %	15-16
	375 g		17½-18½
Add 500 ml cold water. (250 g), Add 750 ml cold water. (375 g) Stand for 5 minutes.			
Brown Rice (Parboiled)	250 g	90 %	20-21
	375 g		22-23
	Add 500 ml cold water. (250 g), Add 750 ml cold water. (375 g) Stand for 5 minutes.		
Mixed Rice (Rice + Wild Rice)	250 g	90 %	16-17
	Add 500 ml cold water. Stand for 5 minutes.		

Food	Serving Size	Power	Time (min.)
Mixed Corn (Rice + Grain)	250 g	90 %	17-18
	Add 400 ml cold water. Stand for 5 minutes.		
Pasta	250 g	90 %	10-11
	Add 1000 ml hot water. Stand for 5 minutes.		

## Reheating guide

### General

This reheating guide is based on the condition that the room temperature is between 18 °C and 20 °C for liquid, and between 5 °C and 7 °C for chilled food. Follow the operating time, power level, and standing time specified in this table.

Food	Serving Size (g)	Power	Time (min.)
Drinks (Coffee, tea and water)	150 ml (1 cup)	90 %	1-1½
	300 ml (2 cups)		2-2½
	450 ml (3 cups)		3-3½
	600 ml (4 cups)		3½-4
	Pour into cups and reheat uncovered: 1 cup in the centre, 2 cups opposite of each other, 3 cups in a circle. Keep in microwave oven during standing time and stir well. Stand for 1-2 minutes.		
Soup (Chilled)	250 g	90 %	2½-3
	350 g		3-3½
	450 g		3½-4
	550 g		4½-5
	Pour into a deep ceramic plate or deep ceramic bowl. Cover with plastic lid. Stir well after reheating. Stir again before serving. Stand for 2-3 minutes.		
Stew (Chilled)	350	60 %	4½-5½
	Put stew in a deep ceramic plate. Cover with plastic lid. Stir occasionally during reheating and again before standing and serving. Stand for 2-3 minutes.		
Pasta with Sauce (Chilled)	350	60 %	3½-4½
	Put pasta (e.g. spaghetti or egg noodles) on a flat ceramic plate. Cover with microwave cling film. Stir before serving. Stand for 3 minutes.		

# Cooking smart

Food	Serving Size (g)	Power	Time (min.)
Filled Pasta with Sauce (Chilled)	350	60 %	4-5
	Put filled pasta (e.g. ravioli, tortellini) in a deep ceramic plate. Cover with plastic lid. Stir occasionally during reheating and again before standing and serving. Stand for 3 minutes.		
Plated Meal (Chilled)	350	60 %	4½-5
	450		5½-6½
Plate a meal of 2-3 chilled components on a ceramic dish. Cover with microwave cling-film. Stand for 3 minutes.			
Cheese Fondue Ready-to- Serve (Chilled)	400	60 %	6-7
	Put the ready-to-serve cheese fondue in a suitable sized glass pyrex bowl with lid. Stir occasionally during and after reheating. Stir well before serving. Stand for 1-2 minutes.		

## Special care for baby food

To prevent accidents such as burns, special care must be taken for baby food before serving. Make sure to strictly follow this reheating guide for baby food.

### Baby food

- Use a deep ceramic plate and cover it with a plastic lid.
- Recommended serving temperature is 30-40 °C.

### Baby milk

- Use a sterilised glass bottle and reheat it uncovered.
- Remove the teat before reheating. Otherwise, the milk in the bottle boils over.

Food	Serving Size	Power	Time (sec.)
Baby Food (Vegetables + Meat)	190 g	60 %	30
	Empty into ceramic deep plate. Cook covered. Stir after cooking time. Before serving, stir well and check the temperature carefully. Stand for 2-3 minutes.		
Baby Porridge (Grain + Milk + Fruit)	190 g	60 %	20
	Empty into ceramic deep plate. Cook covered. Stir after cooking time. Before serving, stir well and check the temperature carefully. Stand for 2-3 minutes.		
Baby Milk	100 ml	30 %	30-40
	200 ml		60-70
Stir or shake well and pour into a sterilised glass bottle. Place into the centre of turn-table. Cook uncovered. Shake well and stand for at least 3 minutes. Before serving, shake well and check the temperature carefully.			

## Defrosting guide

This defrosting guide is based on the condition that frozen food is between -18 °C and -20 °C in internal temperatures. The standing time varies depending on the food type (meat or vegetables) and serving size (thinner or thicker pieces of food).

- Put frozen food in a microwave-safe container uncovered.
- Turn it over halfway through defrosting time and drain well when complete.

	Food	Serving Size	Power	Time (min.)
Meat	Minced Meat	250 g	20 %	6-7
		500 g		8-13
	Pork Steaks	250 g		7-8
Place the meat on turntable. Shield thinner edges with aluminium foil. Turn over after half of defrosting time! Stand for 15-30 minutes.				
Poultry	Chicken Pieces	500 g (2 pcs)	20 %	14-15
	Whole Chicken	1200 g		32-34
	First, put chicken pieces first skin-side down, whole chicken first breast-side-down on a flat ceramic plate. Shield the thinner parts like wings and ends with aluminium foil. Turn over after half of defrosting time! Stand for 15-60 minutes.			
Fish	Fish Fillets	200 g	20 %	6-7
	Whole Fish	400 g		11-13
	Put frozen fish in the middle of a flat ceramic plate. Arrange the thinner parts under the thicker parts. Shield narrow ends of fillets and tail of whole fish with aluminium foil. Turn over after half of defrosting time! Stand for 10-25 minutes.			
Fruits	Berries	300 g	20 %	6-7
	Spread fruit on a flat, round glass dish (with a large diameter). Stand for 5-10 minutes.			
Bread	Bread Rolls (Each ca. 50 g)	2 pcs	20 %	1-1½
		4 pcs		2½-3
	Toast/Sandwich	250 g		4-4½
	German Bread (Wheat + Rye Flour)	500 g		7-9
Arrange rolls in a circle or bread horizontally on kitchen paper in the middle of turntable. Turn over after half of defrosting time! Stand for 5-20 minutes.				

# Cooking smart

---

## Quick & Easy

---

### Melting crystallized honey

Put 20 g crystallized honey into a small deep glass dish.  
Heat for 20-30 seconds using 30 %, until honey is melted.

### Melting gelatine

Lay dry gelatine sheets (10 g) for 5 minutes into cold water.  
Put drained gelatine into a small glass pyrex bowl.  
Heat for 1 minute using 30 %.  
Stir after melting.

### Cooking glaze/icing (for cake and gateaux)

Mix instant glaze (approximately 14 g) with 40 g sugar and 250 ml cold water.  
Cook uncovered in a glass pyrex bowl for 3½ to 4½ minutes using 90 %, until glaze/icing is transparent. Stir twice during cooking.

### Cooking jam

Put 600 g fruits (for example mixed berries) in a suitable sized glass pyrex bowl with lid.  
Add 300 g preserving sugar and stir well.  
Cook covered for 10-12 minutes using 90 %.  
Stir several times during cooking. Empty directly into small jam glasses with twist-off lids. Stand on lid for 5 minutes.

### Cooking pudding/ custard

Mix pudding powder with sugar and milk (500 ml) by following the manufacturers instructions and stir well. Use a suitable sized glass pyrex bowl with lid. Cook covered for 6½ to 7½ minutes using 90 %.  
Stir several times well during cooking.

### Browning almond slices

Spread 30 g sliced almonds evenly on a medium sized ceramic plate.  
Stir several times during browning for 3½ to 4½ minutes using 60 %.  
Let it stand for 2-3 minutes in the oven. Use oven gloves while taking out!

# Cookware guide

To cook food in the microwave oven, the microwaves must be able to penetrate the food, without being reflected or absorbed by the dish used.

Care must therefore be taken when choosing the cookware. If the cookware is marked microwave-safe, you do not need to worry.

The following table lists various types of cookware and indicates whether and how they should be used in a microwave oven.

Cookware	Microwave-safe	Comments
Aluminum foil	✓X	Can be used in small quantities to protect areas against overcooking. Arcing can occur if the foil is too close to the oven wall or if too much foil is used.
Crust plate	✓	Do not preheat for more than 8 minutes.
China and earthenware	✓	Porcelain, pottery, glazed earthenware and bone china are usually suitable, unless decorated with a metal trim.
Disposable polyester cardboard dishes	✓	Some frozen foods are packaged in these dishes.
Fast-food packaging		
• Polystyrene cups containers	✓	Can be used to warm food. Overheating may cause the polystyrene to melt.
• Paper bags or newspaper	X	May catch fire.
• Recycled paper or metal trims	X	May cause arcing.
Glassware		
• Oven-to-tableware	✓	Can be used, unless decorated with a metal trim.
• Fine glassware	✓	Can be used to warm foods or liquids. Delicate glass may break or crack if heated suddenly.
• Glass jars	✓	Must remove the lid. Suitable for warming only.
Metal		
• Dishes	X	May cause arcing or fire.
• Freezer bag twist ties	X	

# Cookware guide

Cookware	Microwave-safe	Comments
Paper <ul style="list-style-type: none"> <li>Plates, cups, napkins and kitchen paper</li> <li>Recycled paper</li> </ul>	✓	For short cooking times and warming. Also to absorb excess moisture.  May cause arcing.
Plastic <ul style="list-style-type: none"> <li>Containers</li> <li>Cling film</li> <li>Freezer bags</li> </ul>	✓  ✓  ✓X	Particularly if heat-resistant thermoplastic. Some other plastics may warp or discolour at high temperatures. Do not use Melamine plastic.  Can be used to retain moisture. Should not touch the food. Take care when removing the film as hot steam will escape.  Only if boilable or oven-proof. Should not be airtight. Prick with a fork, if necessary.
Wax or grease-proof paper	✓	Can be used to retain moisture and prevent spattering.

✓ : Recommended

✓X : Use caution

X : Unsafe

# Troubleshooting

## Troubleshooting

If you have any of the problems listed below try the solutions given.

Problem	Cause	Action
<b>General</b>		
The buttons cannot be pressed properly.	Foreign matter may be caught between the buttons.	Remove the foreign matter and try again.
	For touch models: Moisture is on the exterior.	Wipe the moisture from the exterior.
	Child lock is activated.	Deactivate Child lock.
The time is not displayed.	Power is not supplied.	Make sure power is supplied.
	The Eco (power-saving) function is set.	Turn off the Eco function.
The oven does not work.	Power is not supplied.	Make sure power is supplied.
	The door is open.	Close the door and try again.
	The door open safety mechanisms are covered in foreign matter.	Remove the foreign matter and try again.
The oven stops while in operation.	The user has opened the door to turn food over.	After turning over the food, press the <b>Start</b> button again to start operation.
The power turns off during operation.	The oven has been cooking for an extended period of time.	After cooking for an extended period of time, let the oven cool.
	The cooling fan is not working.	Listen for the sound of the cooling fan.
	Trying to operate the oven without food inside.	Put food in the oven.
	There is not sufficient ventilation space for the oven.	There are intake/exhaust outlets on the front and rear of the oven for ventilation. Keep the gaps specified in the product installation guide.
	Several power plugs are being used in the same socket.	Designate only one socket to be used for the oven.
There is no power to the oven.	Power is not supplied.	Make sure power is supplied.



# Troubleshooting

Problem	Cause	Action
There is a popping sound during operation, and the oven doesn't work.	Cooking sealed food or using a container with a lid may causes popping sounds.	Do not use sealed containers as they may burst during cooking due to expansion of the contents.
The oven exterior is too hot during operation.	There is not sufficient ventilation space for the oven. There are intake/exhaust outlets on the front and rear of the oven for ventilation.	Keep the gaps specified in the product installation guide.
	Objects are on top of the oven.	Remove all objects on the top of the oven.
The door cannot be opened properly.	Food residue is stuck between the door and oven interior.	Clean the oven and then open the door.
The oven does not heat.	The oven may not work, too much food is being cooked, or improper cookware is being used.	Put one cup of water in a microwave-safe container and run the microwave for 1-2 minutes to check whether the water is heated. Reduce the amount of food and start the function again. Use a cooking container with a flat bottom.
Heating is weak or slow.	The oven may not work, too much food is being cooked, or improper cookware is being used.	Put one cup of water in a microwave-safe container and run the microwave for 1-2 minutes to check whether the water is heated. Reduce the amount of food and start the function again. Use a cooking container with a flat bottom.
The warm function does not work.	The oven may not work, too much food is being cooked, or improper cookware is being used.	Put one cup of water in a microwave-safe container and run the microwave for 1-2 minutes to check whether the water is heated. Reduce the amount of food and start the function again. Use a cooking container with a flat bottom.

Problem	Cause	Action
The thaw function does not work.	The oven may not work, too much food is being cooked, or improper cookware is being used.	Put one cup of water in a microwave-safe container and run the microwave for 1-2 minutes to check whether the water is heated. Reduce the amount of food and start the function again. Use a cooking container with a flat bottom.
The interior light is dim or does not turn on.	The door has been left open for a long time.	The interior light may automatically turn off when the Eco function operates. Close and reopen the door or press the <b>Cancel</b> button.
	The interior light is covered by foreign matter.	Clean the inside of the oven and check again.
A beeping sound occurs during cooking.	If the Auto Cook function is being used, this beeping sound means it's time to turn over the food during thawing.	After turning over the food, press the <b>Start</b> button again to restart operation.
The oven is not level.	The oven is installed on an uneven surface.	Make sure the oven is installed on flat, stable surface.
There are sparks during cooking.	Metal containers are used during the oven/thawing functions.	Do not use metal containers.
When power is connected, the oven immediately starts to work.	The door is not properly closed.	Close the door and check again.
There is electricity coming from the oven.	The power or power socket is not properly grounded.	Make sure the power and power socket are properly grounded.
There is water dripping.	There may be water or steam in some cases depending on the food. This is not an oven malfunction.	Let the oven cool and then wipe with a dry dish towel.
There is steam through a crack in the door.	There may be water or steam in some cases depending on the food. This is not an oven malfunction.	Let the oven cool and then wipe with a dry dish towel.
There is water left in the oven.	There may be water or steam in some cases depending on the food. This is not an oven malfunction.	Let the oven cool and then wipe with a dry dish towel.

# Troubleshooting

Problem	Cause	Action
The brightness inside the oven varies.	Brightness changes depending on power output changes according to function.	Power output changes during cooking are not malfunctions. This is not an oven malfunction.
Cooking is finished, but the cooling fan is still running.	To ventilate the oven, the cooling fan continues to run for about 3 minutes after cooking is complete.	This is not an oven malfunction.
Pressing the <b>+30sec</b> button operates the oven.	This happens when the oven was not operating.	The microwave oven is designed to operate by pressing the <b>+30sec</b> button when it was not operating.
<b>Turntable</b>		
While turning, the turntable comes out of place or stops turning.	There is no roller ring, or the roller ring is not properly in place.	Install the roller ring and then try again.
The turn table drags while turning.	The roller ring is not properly in place, there is too much food, or the container is too large and touches the inside of the microwave.	Adjust the amount of food and do not use containers that are too large.
The turn table rattles while turning and is noisy.	Food residue is stuck to the bottom of the oven.	Remove any food residue stuck to the bottom of the oven.

---

## Information code

Code	Description	Action
C-d0	Control buttons are pressed over 10 seconds	Clean the keys and check if there is water on the surface around key. If it occurs again, turn off the microwave oven over 30 seconds and try setting again. If it appears again, call your local SAMSUNG Customer Care Centre.

 **NOTE**

If the suggested solution does not solve the problem, contact your local SAMSUNG Customer Care Centre.

# Technical specifications

SAMSUNG strives to improve its products at all times. Both the design specifications and these user instructions are thus subject to change without notice.

Model	MS11J5023A*
Power source	120 V ~ 60 Hz AC
Power consumption Microwave	1500 W
Output power	900 W
Magnetron	OM75P (31)
Cooling method	Cooling fan motor
Operating frequency	2450 MHz
Dimensions (W x H x D) Outside (Included Handle) Oven cavity	20 <sup>11</sup> / <sub>32</sub> X 11 <sup>11</sup> / <sub>16</sub> X 16 <sup>27</sup> / <sub>32</sub> (in) 14 <sup>7</sup> / <sub>128</sub> X 10 <sup>1</sup> / <sub>32</sub> X 14 <sup>7</sup> / <sub>128</sub> (in)
Volume	1.1 cu.ft
Weight Net/Gross	31.9 lbs. / 35.2 lbs.

# Warranty

---

## Samsung microwave oven

---

### Limited warranty to original purchaser

This SAMSUNG brand product, as supplied and distributed by Samsung Electronics America, Inc. (SAMSUNG) and delivered new, in the original carton to the original consumer purchaser, is warranted by SAMSUNG against manufacturing defects in materials and workmanship for a limited warranty period of:

#### **ONE (1) YEAR PARTS AND LABOR, TEN (10) YEARS PARTS WARRANTY FOR MAGNETRON**

Samsung will charge a repair fee for replacing an accessory or repairing a cosmetic defect if the damage to the unit and/or damage to or loss of the accessory was caused by the customer. Items this stipulation covers include:

- A Dented, Scratched, or Broken Door, Handle, Out-Panel, or Control Panel
- A Broken or missing Tray, Guide Roller, Coupler, Filter, or Wire Rack

User Replaceable Parts may be sent to the customer for unit repair. If necessary, a Service Engineer can be dispatched to perform service.

This limited warranty begins on the original date of purchase, and is valid only on products purchased and used in the United States. To receive warranty service, the purchaser must contact SAMSUNG for problem determination and service procedures. Warranty service can only be performed by a SAMSUNG authorized service center. The original dated bill of sale must be presented upon request as proof of purchase to SAMSUNG or SAMSUNG's authorized service center.

SAMSUNG will repair or replace this product, at our option and at no charge as stipulated herein, with new or reconditioned parts or products if found to be defective during the limited warranty period specified above. All replaced parts and products become the property of SAMSUNG and must be returned to SAMSUNG. Replacement parts and products assume the remaining original warranty, or ninety (90) days, whichever is longer.

In-home service will be provided during the warranty labor period subject to availability within the contiguous United States. In-home service is not available in all areas. To receive in-home service, the product must be unobstructed and accessible to service personnel. If during in-home service repair can not be completed, it may be necessary to remove, repair and return the product. If in-home service is unavailable, SAMSUNG may elect, at our option, to provide for transportation of our choice to and from a SAMSUNG authorized service center. Otherwise, transportation to and from the SAMSUNG authorized service center is the responsibility of the purchaser.

# Warranty

---

This limited warranty covers manufacturing defects in materials and workmanship encountered in normal, noncommercial use of this product and shall not apply to the following, including, but not limited to: damage which occurs in shipment; delivery and installation; applications and uses for which this product was not intended; altered product or serial numbers; cosmetic damage or exterior finish; accidents, abuse, neglect, fire, water, lightning or other acts of nature; use of products, equipment, systems, utilities, services, parts, supplies, accessories, applications, installations, repairs, external wiring or connectors not supplied or authorized by SAMSUNG which damage this product or result in service problems; incorrect electrical line voltage, fluctuations and surges; customer adjustments and failure to follow operating instructions, cleaning, maintenance and environmental instructions that are covered and prescribed in the instruction book; problems caused by pest infestations, and overheating or overcooking by user; glass tray or turntable; reduced magnetron power output related to normal aging. SAMSUNG does not warrant uninterrupted or error-free operation of the product.

---

THERE ARE NO EXPRESS WARRANTIES OTHER THAN THOSE LISTED AND DESCRIBED ABOVE, AND NO WARRANTIES WHETHER EXPRESS OR IMPLIED, INCLUDING, BUT NOT LIMITED TO, ANY IMPLIED WARRANTIES OF MERCHANTABILITY OR FITNESS FOR A PARTICULAR PURPOSE, SHALL APPLY AFTER THE EXPRESS WARRANTY PERIODS STATED ABOVE, AND NO OTHER EXPRESS WARRANTY OR GUARANTY GIVEN BY ANY PERSON, FIRM OR CORPORATION WITH RESPECT TO THIS PRODUCT SHALL BE BINDING ON SAMSUNG. SAMSUNG SHALL NOT BE LIABLE FOR LOSS OF REVENUE OR PROFITS, FAILURE TO REALIZE SAVINGS OR OTHER BENEFITS, OR ANY OTHER SPECIAL, INCIDENTAL OR CONSEQUENTIAL DAMAGES CAUSED BY THE USE, MISUSE OR INABILITY TO USE THIS PRODUCT, REGARDLESS OF THE LEGAL THEORY ON WHICH THE CLAIM IS BASED, AND EVEN IF SAMSUNG HAS BEEN ADVISED OF THE POSSIBILITY OF SUCH DAMAGES. NOR SHALL RECOVERY OF ANY KIND AGAINST SAMSUNG BE GREATER IN AMOUNT THAN THE PURCHASE PRICE OF THE PRODUCT SOLD BY SAMSUNG AND CAUSING THE ALLEGED DAMAGE. WITHOUT LIMITING THE FOREGOING, PURCHASER ASSUMES ALL RISK AND LIABILITY FOR LOSS, DAMAGE OR INJURY TO PURCHASER AND PURCHASER'S PROPERTY AND TO OTHERS AND THEIR PROPERTY ARISING OUT OF THE USE, MISUSE OR INABILITY TO USE THIS PRODUCT SOLD BY SAMSUNG NOT CAUSED DIRECTLY BY THE NEGLIGENCE OF SAMSUNG. THIS LIMITED WARRANTY SHALL NOT EXTEND TO ANYONE OTHER THAN THE ORIGINAL PURCHASER OF THIS PRODUCT, IS NONTRANSFERABLE AND STATES YOUR EXCLUSIVE REMEDY.

Some provinces or territories may or may not allow limitations on how long an implied warranty lasts, or the exclusion or limitation of incidental or consequential damages, so the above limitations or exclusions may not apply to you. This warranty gives you specific legal rights, and you may also have other rights which vary from state to state.

To obtain warranty service, please contact SAMSUNG at:

**1-800-SAMSUNG (726-7864) or [www.samsung.com/ca/support](http://www.samsung.com/ca/support) (English),  
[www.samsung.com/ca\\_fr/support](http://www.samsung.com/ca_fr/support) (French)**





Scan this with your smartphone

Scannez le code QR\* ou rendez-vous sur le site [www.samsung.com/spsn](http://www.samsung.com/spsn) pour voir nos vidéos et démonstrations en direct d'utilisation.  
\*Requiert l'installation d'un lecteur sur votre smartphone

Veillez noter que la garantie Samsung n'inclut pas les déplacements du service après-vente pour expliquer le fonctionnement de l'appareil, corriger une installation non correcte ou exécuter des travaux de nettoyage ou d'entretien réguliers.

#### UNE QUESTION ? UN COMMENTAIRE ?

PAYS	N° DE TÉLÉPHONE	SITE INTERNET
U.S.A Consumer Electronics	1-800-SAMSUNG(726-7864)	<a href="http://www.samsung.com/us/support">www.samsung.com/us/support</a>
CANADA	1-800-SAMSUNG(726-7864)	<a href="http://www.samsung.com/ca/support">www.samsung.com/ca/support</a> (English) <a href="http://www.samsung.com/ca_fr/support">www.samsung.com/ca_fr/support</a> (French)

DE68-04366A-00