

USER GUIDE & SERVICE MANUAL

SAFETY • INSTALLATION & INTEGRATION • OPERATING INSTRUCTIONS • MAINTENANCE • SERVICE



U-LINE

RIGHT PRODUCT. RIGHT PLACE. RIGHT TEMPERATURE. SINCE 1962.

Modular 3000 Series • 3045CLR • 45 cm Clear Ice Machine

Tip: Click on any section below to jump directly there

Contents

Intro

Safety

Safety and Warning

Disposal And Recycling

Installation

Environmental Requirements

Electrical

Cutout Dimensions

Product Dimensions

Side by Side Installation

Water Hookup

Drain

Drain Pump

Anti-Tip Bracket

General Installation

Integrated Panel Dimensions

Integrated Grille / Plinth Dimensions

Integrated Panel Installation

Grille / Plinth Installation

Door Swing

Door Stop

Door Adjust

Operating Instructions

First Use

Control Operation

Ice

Sabbath Mode

Airflow and Product Loading

Maintenance

Cleaning

Cleaning Condenser

Extended Non-Use

Service

Troubleshooting

Wire Diagram

Product Liability

Warranty Claims

Parts

Ordering Replacement Parts

System Diagnosis Guide

Compressor Specifications

Troubleshooting Extended

Control Operation - Service

Thermistor

Defrost

Warranty

WELCOME TO U-LINE

Congratulations on your U-Line purchase. Your product comes from a company with over five decades of premium modular ice making, refrigeration, and wine preservation experience. U-Line continues to be the American leader, delivering versatility and flexibility for multiple applications including residential, light commercial, outdoor and marine use. U-Line's complete global product collection includes Wine Cellars, Drinks Cabinets, Clear Ice Machines, Glass & Solid Door Refrigerators, Drawer Models, and Freezers.

U-Line has captivated those with an appreciation for the finer things with exceptional functionality, style, inspired innovations and attention to even the smallest details. We are known and respected for our unwavering dedication to product design, quality and selection. U-Line is headquartered in Milwaukee, Wisconsin and has shipped product to five continents for over two decades and is proud to have the opportunity to ship to you.

PRODUCT INFORMATION

Looking for additional information on your product? User Guides, Spec Sheets, CAD Drawings, Compliance Documentation, and Product Warranty information are all available for reference and download at u-line.com.

PROPERTY DAMAGE / INJURY CONCERNS

In the unlikely event property damage or personal injury is suspected related to a U-Line product, please take the following steps:

1. U-Line Customer Care must be contacted immediately at +1.414.354.0300.
2. Service or repairs performed on the unit without prior written approval from U-Line is not permitted. If the unit has been altered or repaired in the field without prior written approval from U-Line, claims will not be eligible.

GENERAL INQUIRIES

U-Line Corporation
8900 N. 55th Street
Milwaukee, Wisconsin 53223 USA
Monday - Friday 8:00 am to 4:30 pm UTC/GMT - 5
T: +1.414.354.0300
F: +1.414.354.7905
Email: sales@u-line.com
u-line.com

SERVICE & PARTS ASSISTANCE

Monday - Friday 8:00 am to 4:30 pm UTC/GMT - 5
T: +1.414.354.0300
F: +1.414.354.5696
Service Email: onlineservice@u-line.com
Parts Email: onlineparts@u-line.com

CONNECT WITH US



Designed, engineered and assembled in WI, USA

Safety and Warning

NOTICE

PLEASE READ all instructions before installing, operating, or servicing the appliance.

SAFETY ALERT DEFINITIONS

Throughout this guide are safety items labeled with a Danger, Warning or Caution based on the risk type:



Danger means that failure to follow this safety statement will result in severe personal injury or death.



Warning means that failure to follow this safety statement could result in serious personal injury or death.



Caution means that failure to follow this safety statement may result in minor or moderate personal injury, property or equipment damage.

GENERAL PRECAUTIONS

Use this appliance for its intended purpose only and follow these general precautions with those listed throughout this guide.

This appliance is not intended for use by persons (including children) with reduced physical, sensory or mental capabilities, or lack of experience or knowledge, unless they have been given supervision or instruction concerning use of the appliance by a person responsible for their safety. Children should be supervised to ensure

that they do not play with this appliance. Cleaning and user maintenance shall not be performed by children without supervision.



Do not use electrical appliances inside the food storage compartment of this appliance.



Keep ventilation openings in the appliance enclosure or in the built in structure clear of obstruction.



Do not store explosive substances such as aerosol cans with flammable propellant in this appliance.



Requirement for an external switch in the fixed wiring is specified.



To avoid a hazard due to instability of the appliance, it must be fixed in accordance with the instructions.



Use care when moving and handling the unit. Use gloves to prevent personal injury from sharp edges.

If your model requires defrosting, DO NOT use medical devices or other means to accelerate the defrosting process. DO NOT use an ice pick or other sharp instrument to help speed up defrosting. These instruments can puncture the inner lining or damage the cooling unit. DO NOT use any type of heater to defrost. Using a heater to speed up defrosting can cause personal injury and damage to the inner lining.

NOTICE

Do not lift unit by door handle.

Never install or operate the unit behind closed doors. Be sure front grille (plinth strip/base fascia) is free of obstruction. Obstructing free airflow can cause the unit to malfunction and will void the warranty.

Failure to clean the condenser every six months can cause the unit to malfunction. This could void the warranty.

Allow unit temperature to stabilize for 24 hours before use.

Do not block any internal fans.

Use only genuine U-Line replacement parts. Imitation parts can damage the unit, affect its operation or performance and may void the warranty.

This appliance is intended to be used in household and similar applications such as:

- Staff kitchen areas in shops, office and other working environments.
- Farm houses and by clients in hotels, motels and other residential type environments.
- Bed and breakfast type environments.
- Catering and similar non-retail applications.

Disposal and Recycling



RISK OF CHILD ENTRAPMENT. Before you throw away your old refrigerator or freezer, take off the doors and leave shelves in place so children may not easily climb inside.

If the unit is being removed from service for disposal, check and obey all federal, state and local regulations regarding the disposal and recycling of refrigeration appliances, and follow these steps completely:

1. Remove all consumable contents from the unit.
2. Unplug the electrical cord from its socket.
3. Remove the door(s)/drawer(s).

Environmental Requirements

This model is intended for indoor/interior applications only and is not to be used in installations that are open/exposed to natural elements.

This unit is designed to operate between 50°F (10°C) and 90°F (32°C). Higher ambient temperatures may reduce the unit's ability to reach low temperatures and/or reduce ice production on applicable models.

For best performance, keep the unit out of direct sunlight and away from heat generating equipment.

In climates where high humidity and dew points are present, condensation may appear on outside surfaces. This is considered normal. The condensation will evaporate when the humidity drops.



Damages caused by ambient temperatures of 40°F (4°C) or below are not covered by the warranty.

Electrical



SHOCK HAZARD — Electrical Grounding Required. Never attempt to repair or perform maintenance on the unit until the electricity has been disconnected.

Never remove the round grounding prong from the plug and never use a two-prong grounding adapter.

Altering, cutting or removing power cord, removing power plug, or direct wiring can cause serious injury, fire, loss of property and/or life, and will void the warranty.

Never use an extension cord to connect power to the unit.

Always keep your working area dry.

If the detachable type electric supply cord is damaged, it must be replaced by an equivalent cord available from the manufacturer or its service agent.

NOTICE

Electrical installation must observe all state and local codes. This unit requires connection to a grounded (three-prong), polarized receptacle that has been placed by a qualified electrician.

The unit requires a grounded and polarized 230 VAC, 50 Hz, 8A power supply (normal household current). An individual, properly grounded branch circuit or circuit breaker is recommended. A GFCI (ground fault circuit interrupter) is usually not required for fixed location appliances and is not recommended for your unit because it could be prone to nuisance tripping. However, be sure to consult your local codes.

See CUTOUT DIMENSIONS for recommended receptacle location.

Cutout Dimensions

PREPARE SITE

Your U-Line product has been designed exclusively for a built-in installation. When built-in, your unit does not require additional air space for top, sides, or rear. However, the front grille (plinth strip/base fascia) must NOT be obstructed.

The product is designed and manufactured for seamless integration in the specified cutout opening shown, which requires precise measurements. The opening must be square and plumb front to back. Although not required, you may choose to increase the overall cutout width for ease of installation.

The Modular 3000 Series units are engineered with a variety of adjustment features to help ensure a seamless installation. Adjustable doors, leveling legs and grille will assist in fine tuning the installation.

All 3000 Series models fully integrate into overlay/face frame, inset or European/frameless cabinet styles.



Unit can NOT be installed behind a closed cabinet door.

For cabinet depths less than 24-3/8" (620 mm), electrical socket MUST be located in the adjacent cabinet or recessed in the wall. The power cord length is 6ft (180 cm).

CUTOUT DIMENSIONS

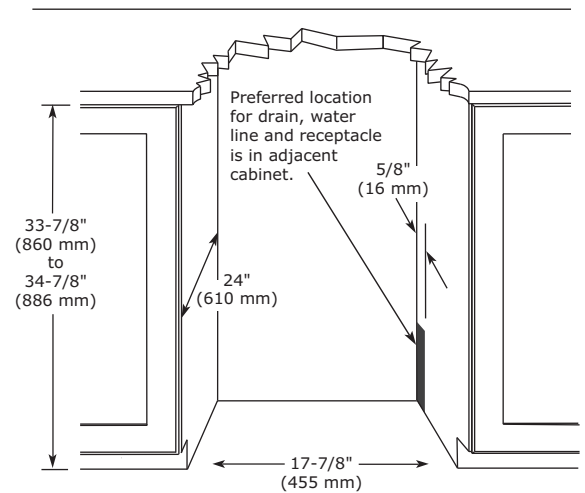

Metric measurements rounded and optimized.

Product Dimensions

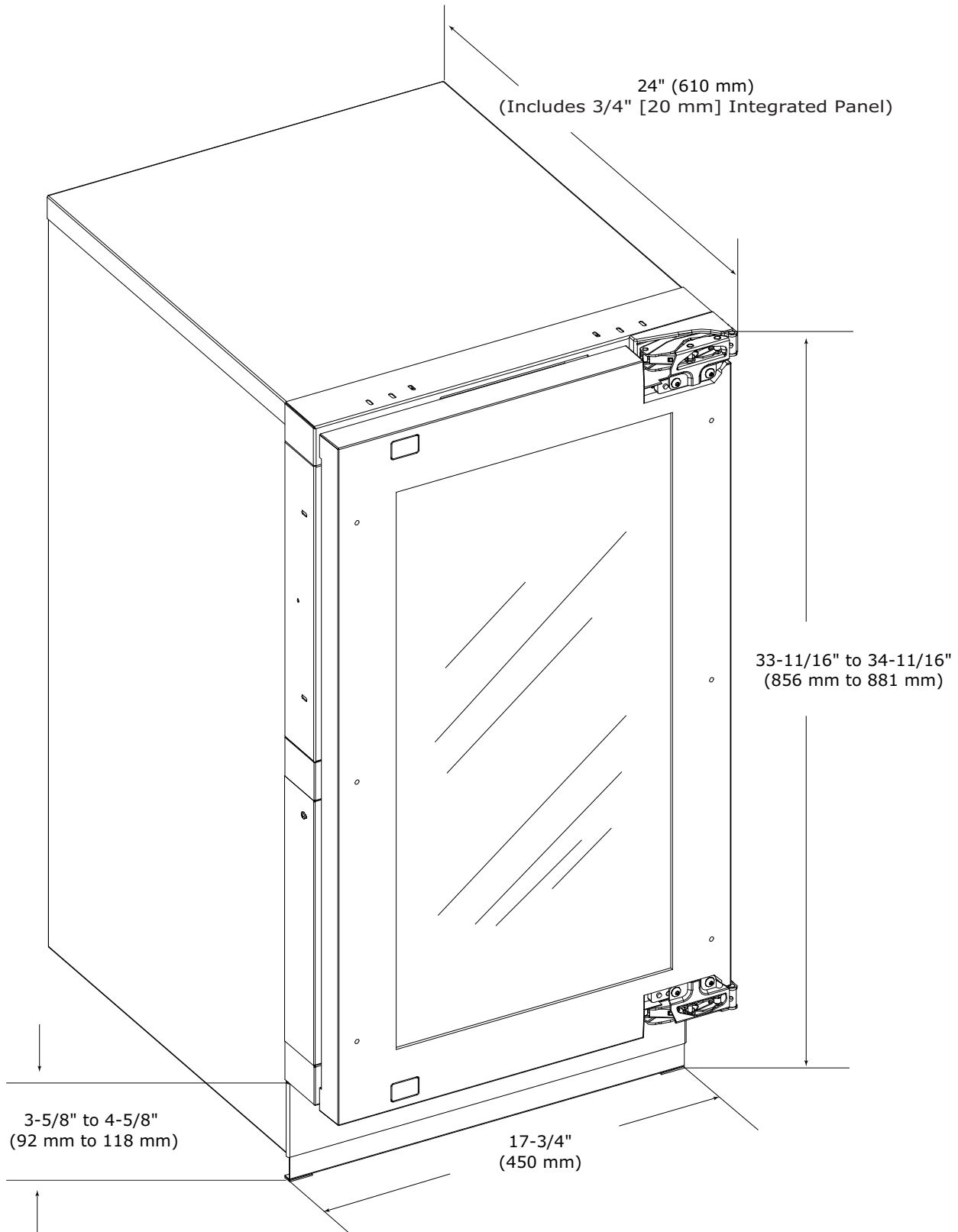

Side-by-Side Installation

OTHER SITE REQUIREMENTS

Side-by-Side Installation

Units must operate from separate, properly grounded electrical receptacles placed according to each unit's electrical specifications requirements.

Cutout width for a side-by-side installation is the total of the widths listed under Cutout Dimensions in each unit's Installation Guide. Each door can be opened individually (one at a time) without interference.

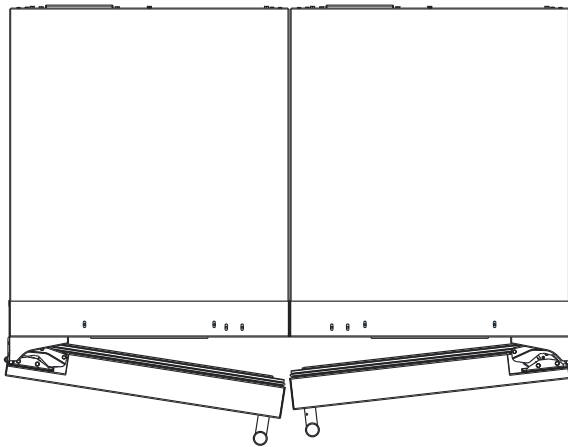

However, to ensure unobstructed door swing (opening both doors at the same time), 1/4" (6.4 mm) of space needs to be maintained between the units.

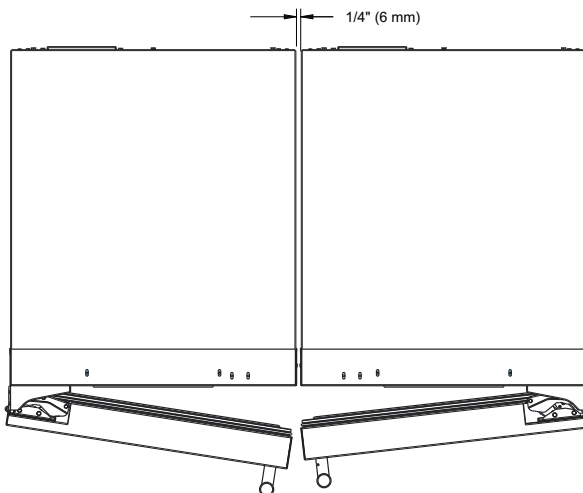

Hinge-by-Hinge Installation (Mullion)

When installing two units hinge-by-hinge, 13/16" (22 mm) is required for integrated models. Additional space may be needed for any knobs, pulls or handles installed.

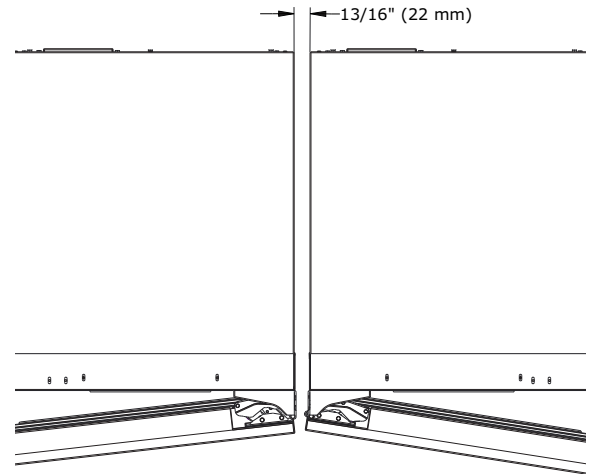

Stainless steel models which include the standard stainless handle will require 4-9/16" (116 mm) to allow both doors to open to 90° at the same time.

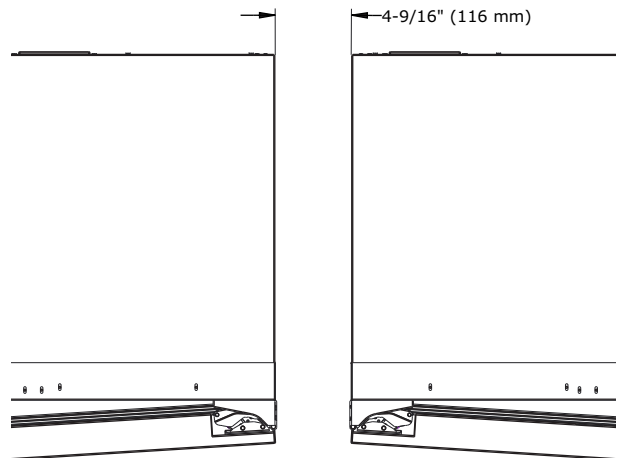

Water Hookup

PREPARE PLUMBING

The water valve uses a standard 1/4" (6.35 mm) compression fitting. U-Line recommends using accessory water hook up kit – part # 80-54674-00. The kit includes a 10' (3 m) braided flexible water supply line and a brass hose fitting. When using a 1/4" (6.35 mm) O.D. soft copper supply line use the brass nut and sleeve included with the unit.



Prior to installation, determine if this product contains a gravity style drain or factory installed drain pump. Products without a drain pump may only use a gravity style drain. Failure to connect water supply or drain line connections properly may result in water leakage, personal injury, and/or property damage. Disconnect power and turn off water to the unit before attempting to alter these connections. These connections are the responsibility of the owner and must be connected per local plumbing code. If you are uncertain of how to safely and properly install this product, contact a licensed plumber.

Water Supply Connection



Connect to potable water supply only.



Review, obey, and understand the local plumbing codes before you install your unit. Connect to the cold water supply. The water pressure should be between 20 and 120 psi (138 and 827 kPa). The water line MUST have a shut-off valve on the supply line.



Do not use any plastic water supply line. The line is under pressure at all times. Plastic may crack or rupture with age and cause damage to your home.

Do not use tape or joint compound when attaching a braided flexible water supply line that includes a rubber gasket. The gasket provides an adequate seal – other materials could cause blockage of the valve.

Failure to follow recommendations and instructions may result in damage and/or harm, flooding or void the product warranty.



Turn off water supply and disconnect electrical supply to unit prior to installation.

Use caution when handling back panel. The edges could be sharp.

1. Turn off water supply and disconnect electrical supply to product prior to attempting installation.
2. Remove the grille/access panel in the front and the back panel.

3. Locate water valve in the front of the unit and thread water supply line through.

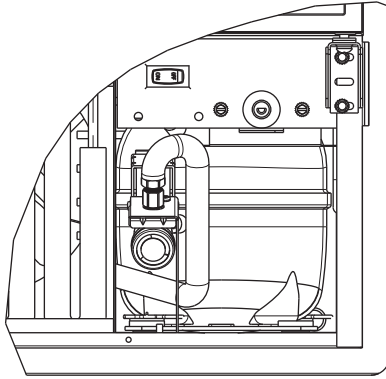

NOTICE

Route the water supply line

through the unit so it does not come into contact with any internal components other than the solenoid valve. Normal operation creates some vibration. A water supply line contacting an internal component or cabinet wall can cause excessive noise during operation or damage to the line.

8. Install retaining clip.

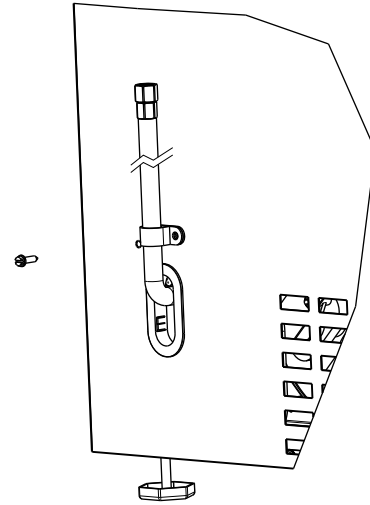

4. On the back panel, break away filler feature in bushing with flat screwdriver.

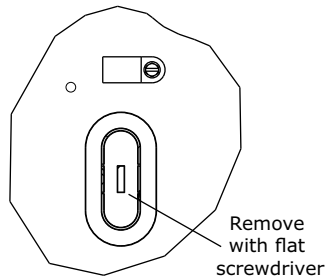

5. Thread water line through back panel hole (with bushing).

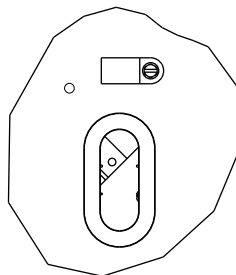

6. Turn on water supply and check for leaks.
7. Reinstall back panel and grille/front access panel.

Drain

Model numbers including “-00” or “-07” do not include a factory installed drain pump.

Model numbers including “-40” or “-47” include a factory installed drain pump.

DRAIN CONNECTION



If your U-Line unit did not come with a factory installed drain pump you must use a gravity style drain connection. For assistance in determining if your unit has a pump please contact U-Line. The floor drain must be large enough to accommodate drainage from all attached drains. Follow these guidelines when installing drain lines to prevent water from flowing back into the ice maker storage bin and/or potentially flowing onto the floor, which may result in personal injury or property damage.

NOTICE

Drain can NOT be located directly below the unit. Unit has a solid base that will not allow the unit to drain below itself.

There is a possibility that hose connections may have loosened during shipment.

Verify all connections and fittings are free from leaks.

GRAVITY DRAIN

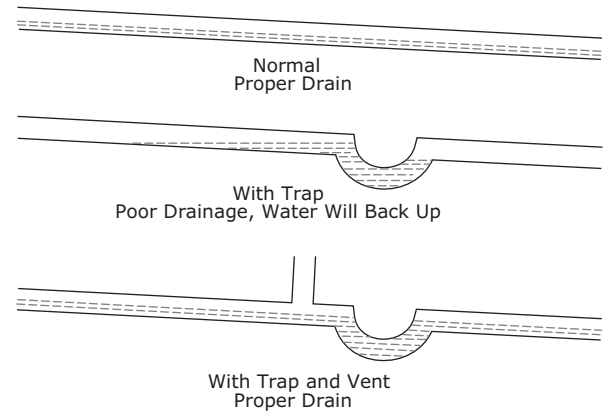

A gravity drain may be used if:

Drain line has at least a 1" drop per 48" (approximately 2 cm drop per 100 cm) of run.

Drain line does not create traps and is vented per local code.

1. Cut the pre-installed drain tube to length.
2. Connect to your local plumbing per the local code.
3. If necessary, insulate drain line to prevent condensation.



Failure to connect water supply or drain line connections properly can result in personal injury and property damage. Gravity drain connections must be routed downward from the rest of the unit at the rate of 1/4" per foot (1 cm per 50 cm).

FACTORY INSTALLED DRAIN PUMP

If your drain line will run up to a stand pipe, disposal or spigot assembly, or does not otherwise meet the requirements for a gravity drain, you may have ordered a pre-installed U-Line P60 drain pump.

If you need to install a P60 drain pump into your unit, see DRAIN PUMP section in the User Manual.

See below for typical installations requiring a drain pump.

Y-Branch Tailpiece
P60 Pump Required

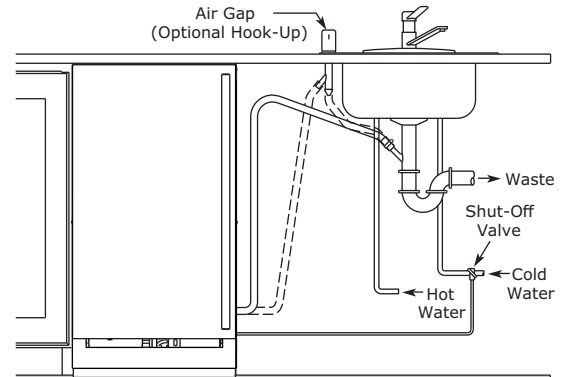

Stand Pipe
P60 Pump Required

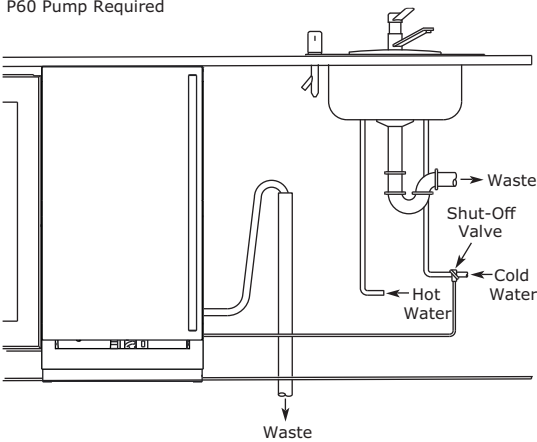

Disposal Assembly
P60 Pump Required

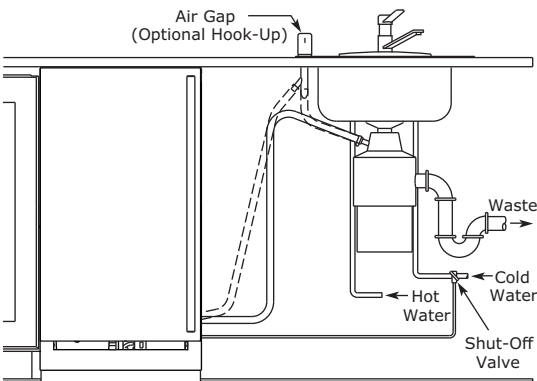

NOTICE

The maximum lift for the P60 drain pump is **10 feet**. This must be done as close to the rear of the unit as possible.

Drain Pump

NOTICE

PLEASE READ this instruction completely before attempting to install or operate the unit. Improper hook-up can result in substantial property damage! If you are unsure of your ability to safely connect the drain pump to the unit, consult a licensed plumber for assistance. Use these instructions to install the U-Line P60-20 drain pump in the U-Line Clear Ice Machine (unit). The drain pump should be installed before installing the unit.

- The U-Line P60-20 drain pump is designed to be used exclusively on the U-Line Clear Ice Machine and is CE recognized only for use on the U-Line Clear Ice Machine.
- U-Line Corporation assumes no warranties or responsibility, whether express or implied, if the P60-20 drain pump is used on another ice machine or product for which it is not CE recognized or listed.
- Modification of the P60-20 drain pump will void all warranties.

NOTICE

Keep your proof of purchase for warranty purposes.

INCLUDED IN KIT:

1. 1x S-shaped Drain Tube
2. 1x Straight Drain Tube (Not used)
3. 1x Vent Tube
4. 1x Braided Discharge Tube (Not included in pump kit. Ice Machine ships with discharge tube installed.)
5. 2x Vent tube Zip Ties
6. 2x Small Worm Gear Clamps
7. 1x Large Worm Gear Clamp
8. 1x P60 Pump
9. 1x Discharge Tub (Used on older models only)

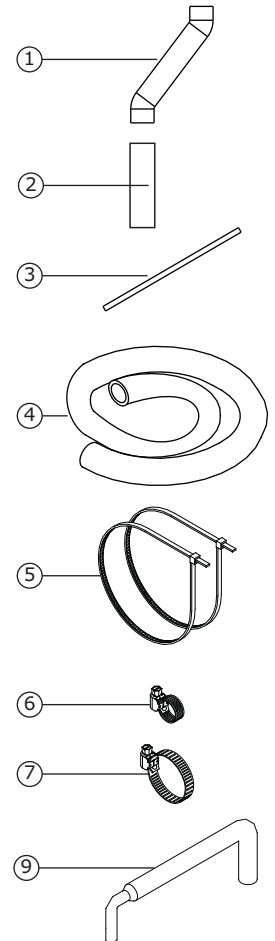

TOOLS REQUIRED:

- 1/4" x 6" Blade Screwdriver
- Adjustable Pliers
- 1/4" Nut Drive

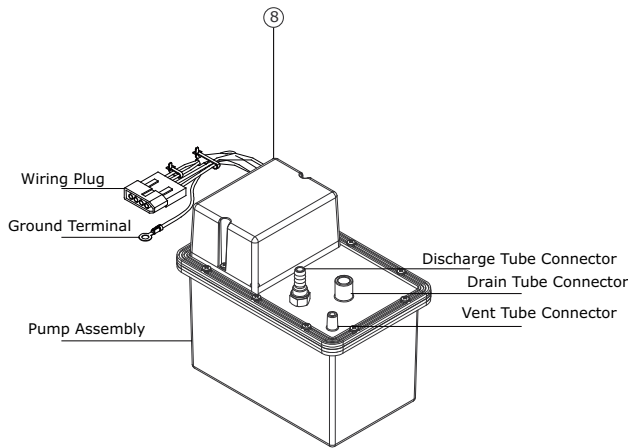

INSTALLATION PROCEDURE



To prevent accidental electrocution, make certain that the floor surfaces surrounding the unit are dry whenever power/electricity is removed from, or applied to the unit.

1. Disconnect your unit from its electrical outlet/socket.
2. Using a screwdriver or 1/4" nut driver, remove the 9 screws from the back panel.
3. Remove the drain line/pipe from the storage bin drain nipple. Save the clamp for pump installation.



To prevent damage to the pump, leave sufficient space between leveling leg and pump.

Note: Slide clamp on hose end before installing hose. Do not tighten clamp until pump and hoses have been installed.

4. Install the 3 hoses and hose clamps to the pump assembly as shown below. Do not tighten clamps at this time.

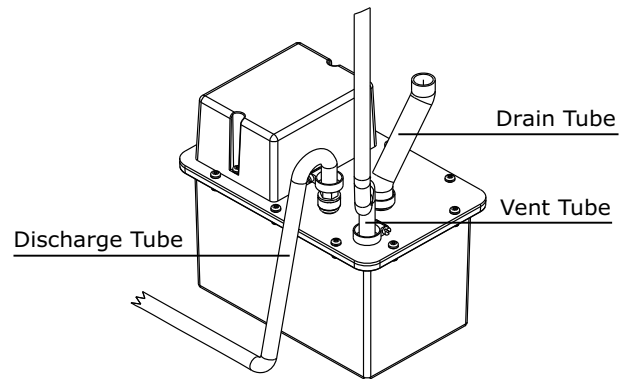
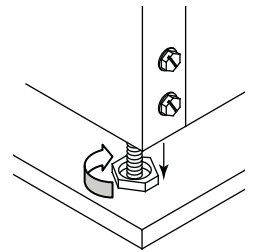

5. Remove the protective paper from the adhesive strip and carefully set pump inside of unit.

6. Unplug jumper block from ice machine wiring harness (jumper block has a single pink wire). Discard jumper block.

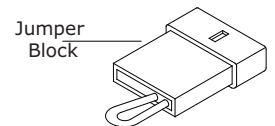

7. Connect pump wiring plug to the ice machine wiring harness connector, where the jumper block was removed. The connector is keyed and can only be inserted one way.

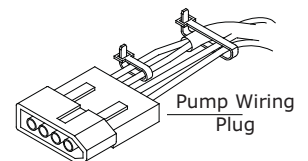

When working with tools inside of unit, be careful so as not to nick or damage any refrigerant lines/pipes or wires.

⚠ WARNING

The back panel serves as a guard. Do not put your hands inside the ice machine cabinet or attempt to touch any components except the discharge tube during testing.

Note: The discharge tube will need to be trimmed. Cut back the tube (MAX of 1/4" on each end) so that no kinks are formed in drain tube.

⚠ CAUTION

Failure to properly secure the vent tube will result in water damage to the unit and surrounding areas. Do not allow vent tube to kink, bend or be obstructed in any way.

⚠ CAUTION

Vent tube must be straight and parallel to insulated tubes. Do not over-tighten the plastic tie wraps. Over-tightening can pinch vent tube closed or cut into insulation.

8. Route the vent tube up the back of the unit, next to the insulated tubes. Secure vent tube vertical to the insulated tubes using plastic tie wraps.

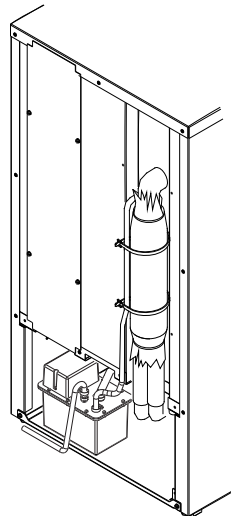

9. Connect pump drain tube to storage bin drain nipple with clamp removed from step 3. Ensure that no kinks are present in the tube.

10. Tighten the clamps on the drain, discharge, and vent tubes with a screwdriver or 1/4" nut driver.

Anti-Tip Bracket



The anti-tip bracket must be installed to prevent the unit from tipping when doors are fully opened or excess weight is placed on the front of the unit.

The anti-tip bracket has multiple mounting options. Mounting will depend on your particular cabinet configuration. Locate 3 #8x5/8" screws included with your unit.

TOP MOUNT

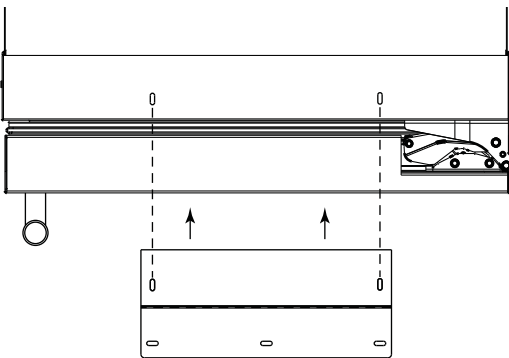

For ease of installation, the anti-tip bracket is pre-installed in the top mount position.

1. Completely slide the unit into its position in the cabinet. Be certain unit height is properly adjusted. (See GENERAL INSTALLATION).
2. Open door completely. Make certain door clears surrounding cabinetry.
3. Using a 3/32" (2.50 mm) drill bit, drill 3 pilot holes 5/8" (16 mm) deep into bottom of counter top. Use the anti-tip bracket as a template.
4. Install 3 #8x5/8" screws into the plate using a #2 Phillips head screwdriver.

SIDE MOUNT

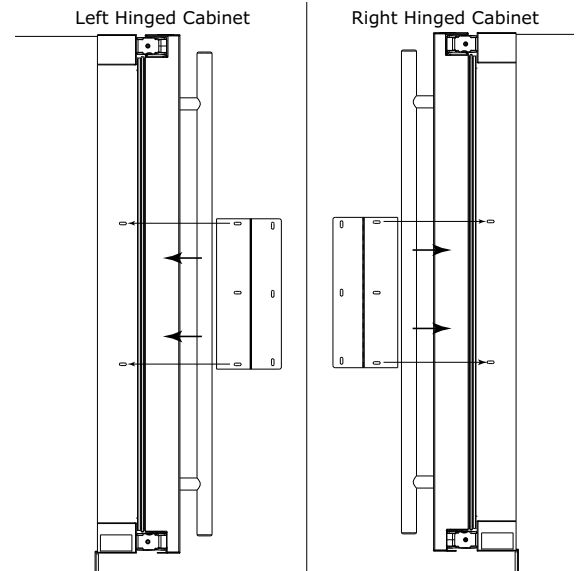

Side mount position is used when you are unable to mount the bracket to the underside of your countertop.

1. Remove the pre-installed anti-tip bracket from the top mount position and align the bracket to the hinge side of the unit as shown above.
2. Reinstall the 2 #8x5/8" screws into the plate using a #2 Phillips head screwdriver.
3. Completely slide the unit into its position in the cabinet. Be certain unit height is properly adjusted. (See GENERAL INSTALLATION).
4. Open door completely. Make certain door clears surrounding cabinetry.
5. Using a 3/32" (2.50 mm) drill bit, drill 3 pilot holes 5/8" (16 mm) deep into cabinetry frame using the anti-tip bracket as a template.
6. Install 3 #8x5/8" screws into the plate using a #2 Phillips head screwdriver.

General Installation

1. Use a level to confirm the unit is level. Level should be placed along top edge and side edge as shown.

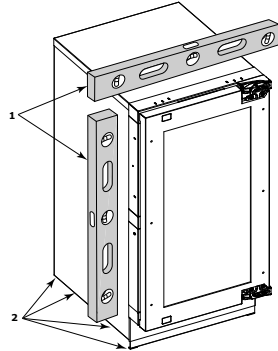

2. If the unit is not level, remove grille and adjust legs as necessary. Use included tool to adjust the height of the rear legs.

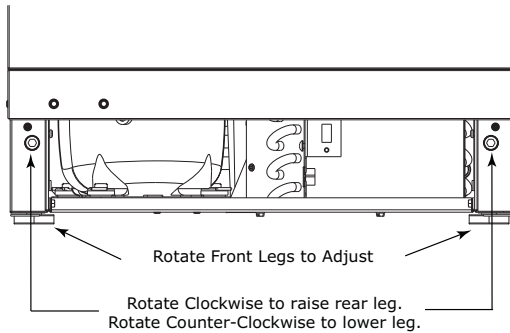

3. Confirm the unit is level after each adjustment and repeat the previous steps until the unit is level.

INSTALLATION TIP

If the room floor is higher than the floor in the cutout opening, adjust the rear legs to achieve a total unit rear height of 1/8" (3 mm) less than the opening's rear height. Shorten the unit height in the front by adjusting the front legs. This allows the unit to be gently tipped into the opening. Adjust the front legs to level the unit after it is correctly positioned in the opening.

INSTALLATION

1. Plug in the power/electrical cord.
2. Gently push the unit into position. Be careful not to entangle the cord or water and drain lines.
3. Re-check the leveling, from front to back and side to side. Make any necessary adjustments. The unit's top surface should be approximately 1/8" (3 mm) below the countertop.
4. Install the anti-tip bracket.
5. Remove the interior packing material and wipe out the inside of the unit with a clean, water-dampened cloth.

Integrated Panel Dimensions

Metric measurements rounded and optimized.

INTEGRATED PANEL

NOTICE

Due to differences in surrounding cabinetry the panel may not perfectly align with door. The procedure below is designed to provide a finished integrated panel that seamlessly integrates with surrounding cabinetry.

Panel Preparation

A full integrated door panel completely covers the door frame and provides a built-in appearance.

NOTICE

The door panel must not weigh more than 20 lbs (10 kg).

It is important to ensure that all drilled holes are drilled to the correct depth in order to avoid splits in the wood when hardware is installed.

1. Cut the panels to the dimensions listed in the diagram below.
2. Optional: Stain or finish panel to desired stain or color. Be sure to closely follow the instructions provided by the manufacturer.
3. Optional: Install handles and hardware.

NOTICE

When applying an integrated panel to a unit, ensure that both sides are finished in order to prevent warping. In some panel installations, the panel may be visible through the glass while the door is open.

Integrated Panel Dimensions

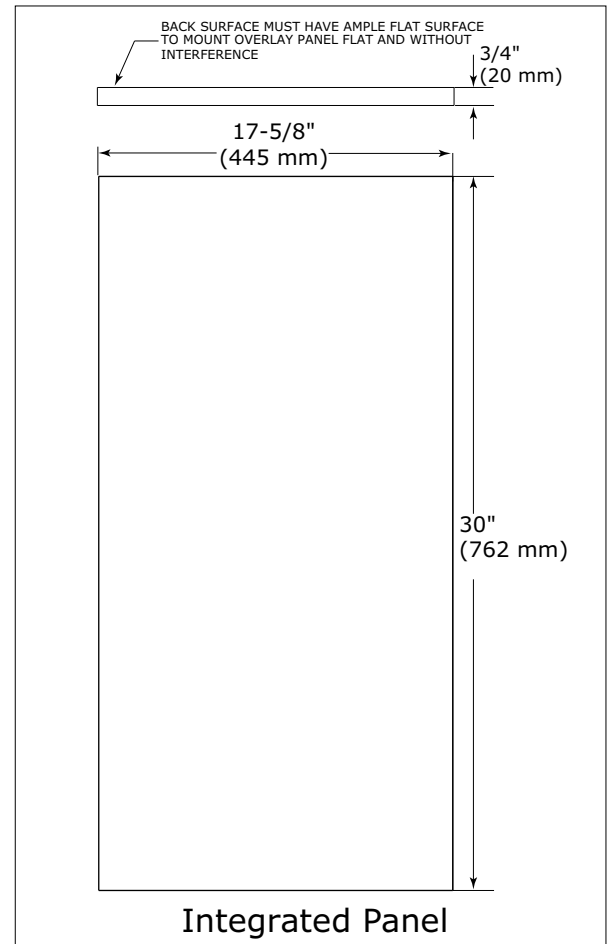

HANDLELESS INTEGRATED DOOR PANEL

The following procedure is designed to provide a finished, handleless solid panel for an 18" (450 mm) door that seamlessly integrates with its surrounding cabinetry.

NOTE: Many cabinet manufacturers provide a ready solution for a handleless, integrated design that can be easily applied to your U-Line 3000 Series model. Consult your cabinet manufacturer for applicable design and installation details. The cabinet manufacturer's solution to this design and integration detail will often result in an integrated panel solution wherein the size of the panel may result in a height dimension taller than what we specify. This can be achieved provided the additional height is positioned above the appliance door.

NOTICE

The integrated panel aligns with the surrounding cabinetry and, due to differences in cabinetry, may not align perfectly with the door.

The appliance will need up to 34-1/2" (876 mm) to the underside of the counter to leave room for leveling adjustments.

A single prepared panel with insert must not weigh more than 20 lbs (10 kg).

Integrated Panel Preparation

1. Cut the main panel to the dimensions below. For details, see the drawings on the next page.

Main panel width	Main panel height
17-5/8" (445 mm)	28-13/16" (732 mm)

2. Create the top design for the handleless feature and the 1/8" (3 mm) notch for the insert(s) indicated on the Top Detail drawing, on the next page.

3. Prepare the insert(s) that will back up the handleless design. **Wooden Insert** – Cut 1/8" (3 mm) thick wooden insert(s) to the dimensions below.

Wooden insert width	Wooden insert height
17-5/8" (445 mm)	3-1/2" (89 mm)

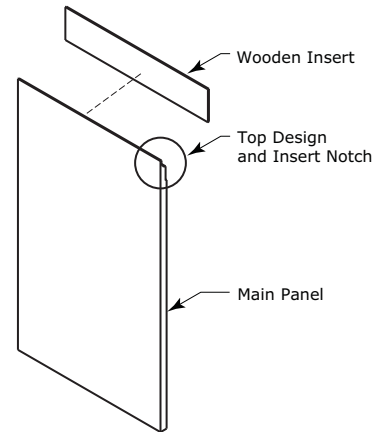

Integrated Panel

4. Optional: Stain or finish panel and wooden insert to desired stain or color. Be sure to closely follow the instructions provided by the manufacturer.

NOTICE

If finishing panel or wooden insert, all sides must be finished to prevent warping.

5. Attach the insert to the panel. Wood glue or equivalent adhesive should be used to attach insert to panel.

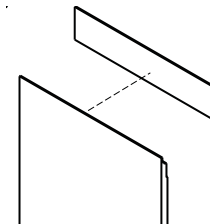

Attach Wooden Insert

Handleless Integrated Panel Dimensions

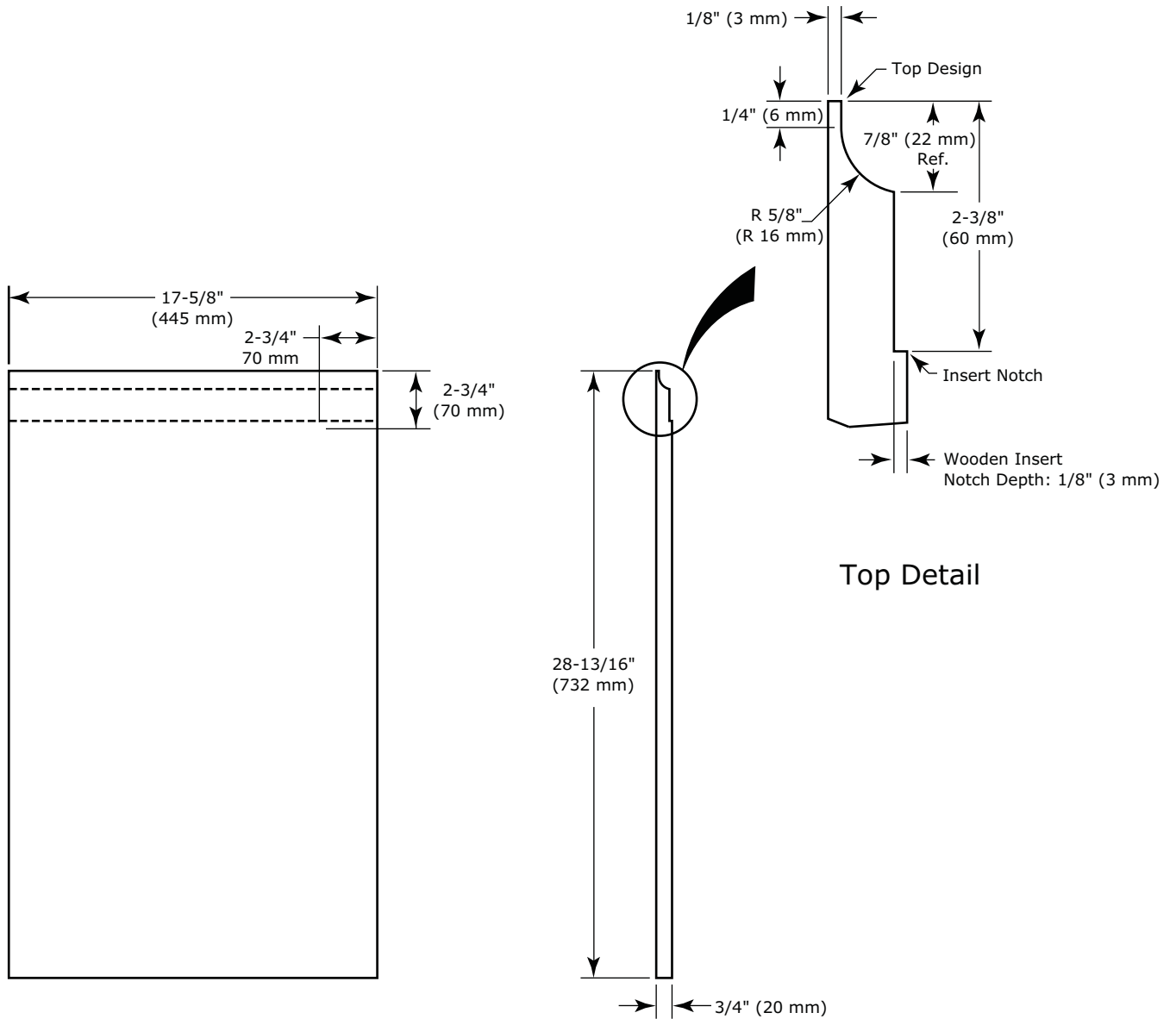

Wooden Insert Dimensions

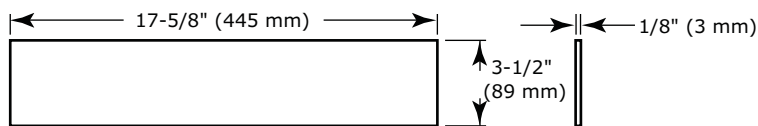

EXTENDED INTEGRATED PANEL

NOTICE

Due to differences in surrounding cabinetry the panel may not perfectly align with door. The procedure below is designed to provide a finished panel that seamlessly integrates with surrounding cabinetry.

Panel Preparation

An extended integrated panel can be used to maintain alignment with an adjacent extended cabinet height or a reduced toe-kick/grille application.

1. Cut the panels to the dimensions listed in the appropriate diagram on the next page.
2. Optional: Stain or finish panel to desired stain or color. Be sure to closely follow the instructions provided by the manufacturer.
3. Optional: Install handles and hardware.

NOTICE

The door panel must not weigh more than 20 lbs (10 kg).

It is important to ensure that all drilled holes are drilled to the correct depth in order to avoid splits in the wood when hardware is installed.

Appliance will need up to 34-1/2" (876 mm) to the underside of the counter to leave room for leveling adjustments.

When applying an integrated panel to a unit, ensure that both sides are finished in order to prevent warping. In some installations, the panel may be visible through the glass while the door is open.

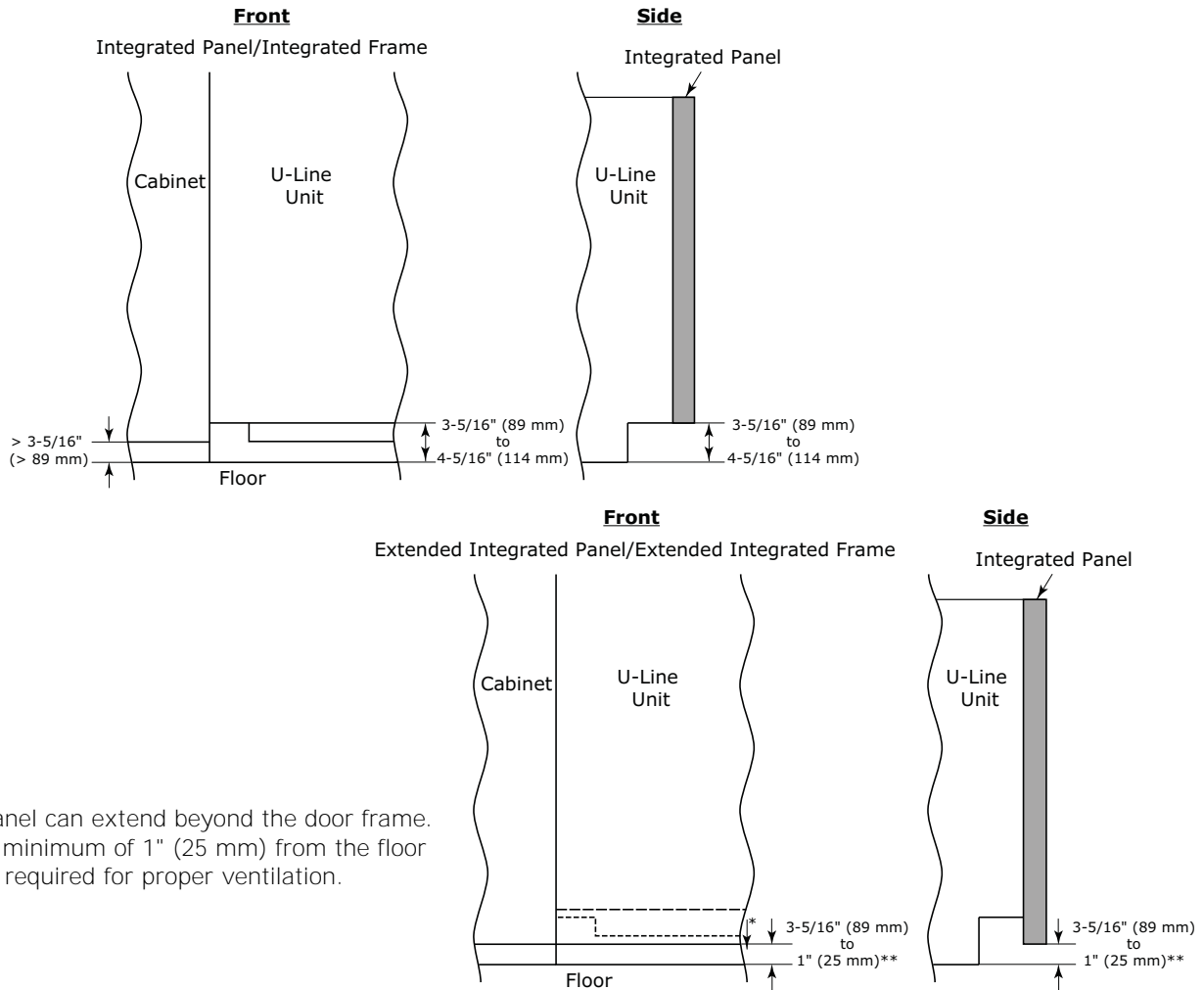

* Panel can extend beyond the door frame.

** A minimum of 1" (25 mm) from the floor is required for proper ventilation.

Extended Integrated Panel Dimensions

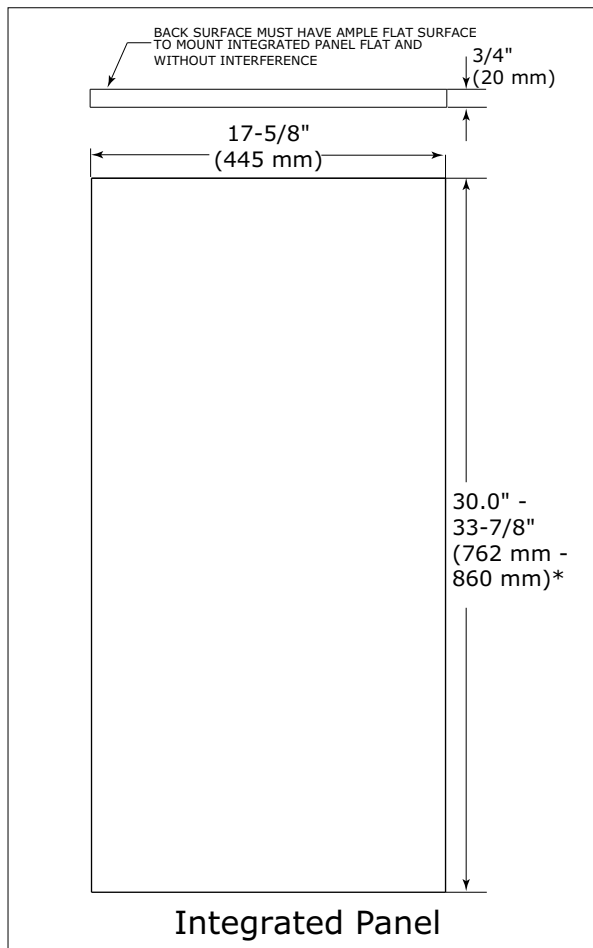

* A minimum of 1" (25 mm) is required from the floor to the bottom of the extended integrated panel/frame for proper ventilation.

Integrated Grille - Plinth Dimensions

INTEGRATED GRILLE (PLINTH STRIP/BASE FASCIA) DIMENSIONS

PREPARE AND INSTALL INTEGRATED GRILLE (PLINTH STRIP/BASE FASCIA)

1. Use the dimensions provided in the diagram to cut and shape your integrated grille (plinth strip/base fascia) panel. Recommended panel thickness is between 1/4" (6 mm) and 3/8" (9 mm). Height will vary from 3-5/16" (84 mm) to 4-5/16" (110 mm) based on your grille (plinth strip/base fascia) height.
2. Finish or stain your grille (plinth strip/base fascia) panel to match your surrounding furniture. Finish front, back and edges to prevent warping. Carefully follow the manufacturer's recommendations for finish application and cure times.
3. Apply double sided tape to the backside of the integrated grill (plinth strip/base fascia). Use the diagram below for reference. U-Line recommends 3M™ VHB™ tape, a high strength bonding tape.

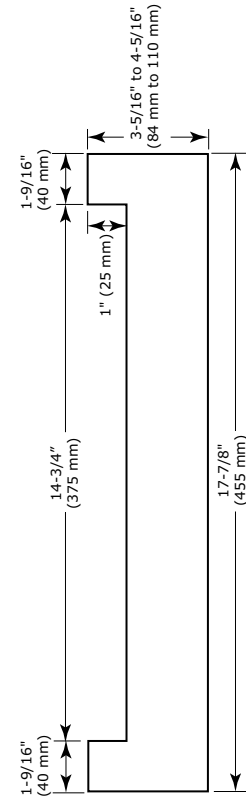

Apply Tape To Shaded Area



4. Remove backing paper from double sided tape.
5. Carefully align grille (plinth strip/base fascia) over integrated panel and press into position.

Integrated Panel Installation

1. Fully open door.

2. Starting at corner, pull gasket away from door.

3. Continue to pull gasket free from gasket channel.

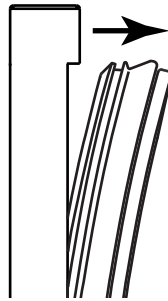

4. Upon removal, lay gasket down on a flat surface.

5. Align top of panel with top edge of door. Center panel on door. (For 3036/3090 models, align panel on the hinge side-edge of door.)

NOTICE

Due to differences in floor construction or surrounding cabinetry, the panel may not sit flush with the top of the door.

6. Secure integrated panel to door using clamps. A robust tape may also be used. U-Line recommends the use of bar clamps to secure the panel to the door. If using tape, be certain the tape will not damage panel finish upon removal.

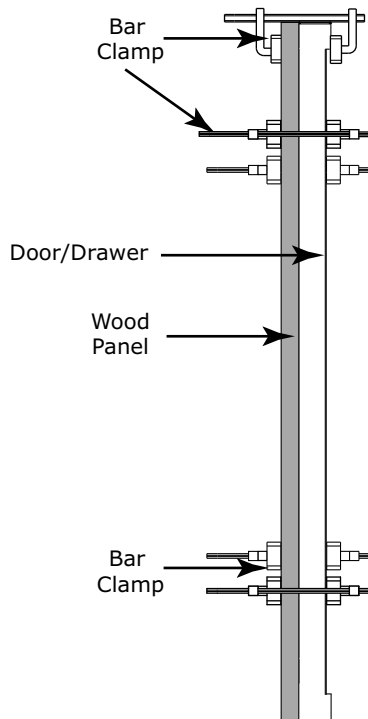

7. Using a 7/64" (3 mm) drill bit, drill 6 pilot holes into the wood panel 1/2" (12 mm) deep using the holes in the door frame as a guide.

NOTICE

It is important to ensure that all drilled holes are drilled to the correct depth in order to avoid splits in the wood when hardwood is installed.

8. Locate 6 of the #6x 1-1/2" (38 mm) screws provided with your unit.

9. Using a Phillips screwdriver, place one screw into each of the 6 pilot holes and screw down. Do not overtighten screws.

10. Ensure the screws sit flush against the bottom of the channel.

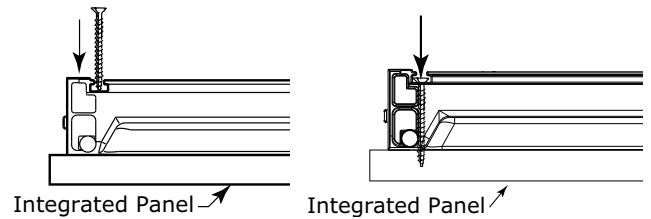

11. Remove clamps from door.

NOTICE

If panel requires additional adjustment after removing clamps, slightly loosen each screw and adjust panel as necessary. Tighten screws upon completion.

12. Starting at the corners, re-install the gasket into the gasket channel in the frame. Make sure the gasket is fully seated.

Grille - Plinth Installation

REMOVING AND INSTALLING GRILLE (PLINTH STRIP/BASE FASCIA)



Disconnect electrical current to the unit before removing the grille (plinth strip/base fascia).

When using the unit, the grille (plinth strip/base fascia) must be installed.

Edges of sheet metal may be sharp.

Removing the grille (plinth strip/base fascia)

1. Disconnect electrical current to unit.
2. Using the included 7/64" Allen wrench, loosen (but do not remove) both grille (plinth strip/base fascia) lock screws. See below.

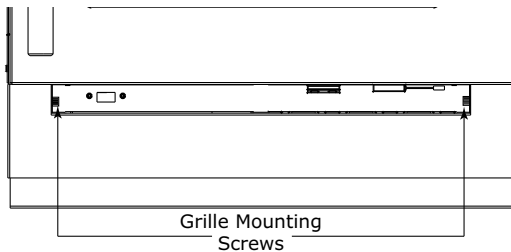

3. Gently pull grille (plinth strip/base fascia) away from unit until it stops.
4. Push grille (plinth strip/base fascia) rails towards the center of the unit to lift rails off lock screws.

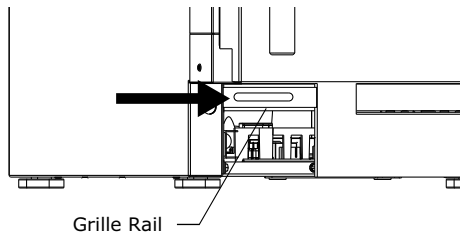

5. Pull grille (plinth strip/base fascia) free from unit.

Installing the grille (plinth strip/base fascia)

1. Align slots in grille (plinth strip/base fascia) rail with screw heads in base of unit
2. Push grille (plinth strip/base fascia) rails towards the center of the unit and set rails over screw head.
3. Slide grille (plinth strip/base fascia) into position. Using included 7/64" Allen wrench tighten grille (plinth strip/base fascia) lock screws.

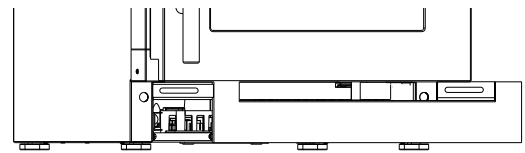

ADJUSTING GRILLE (PLINTH STRIP/BASE FASCIA)

The grille (plinth strip/base fascia) has an automatic vertical plane adjustment and can also be adjusted on its horizontal plane as well. To adjust your grille (plinth strip/base fascia) to match your surrounding furniture, follow the instructions below.

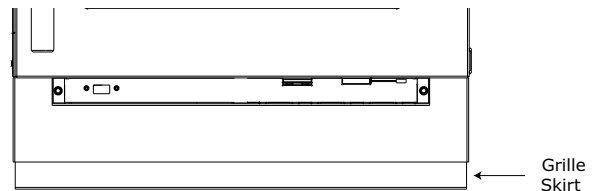

1. Loosen, but do not remove, the lock screws on the inside of the grille (plinth strip/base fascia) rails. Lock screws are located on the inside of each grille (plinth strip/base fascia) rail.
2. The grille (plinth strip/base fascia) can be extended horizontally by pulling out a maximum of 1-1/2" (38 mm). Do not exceed 1-1/2" (38 mm). Secure the lock screws after adjusting.
3. The grille (plinth strip/base fascia) skirt may be manually adjusted to the height of your floor. Simply raise or lower the skirt as needed.

Door Swing

For models that are installed adjacent to a wall, 1/2" (13 mm) clearance is recommended from wall on hinge side to allow the door to open 90°. Allow for additional space for any knobs or pulls installed on the integrated panel/frame.

Units have a zero clearance when installed adjacent to cabinets.

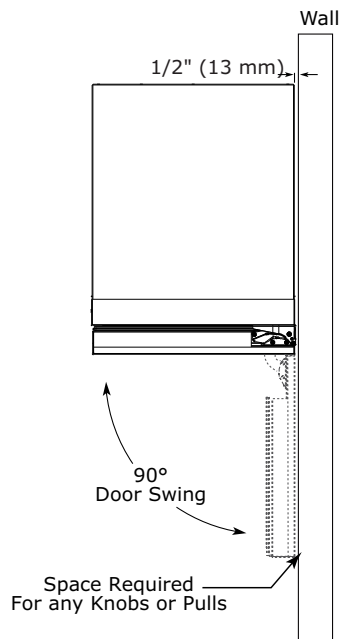

Door Stop

Your U-Line unit was shipped to you with the optional 90° pin.

Your unit's door(s) will open 115° straight from the factory. If you would like the door stop at 90° follow these instructions.

NOTICE

If your unit is already undercounter, it will need to be moved out to access the hinge. With the 90° stop pin in place, you will not be able to replace the hinge cover.

1. Open door approximately 90°.

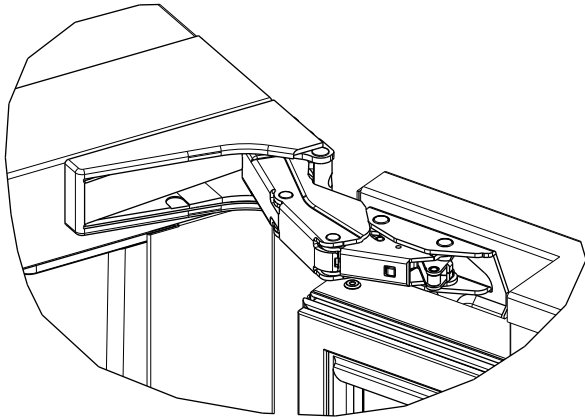

2. Remove hinge cover by lifting top and bottom of hinge cover and sliding the cover inwards to remove from hinge.

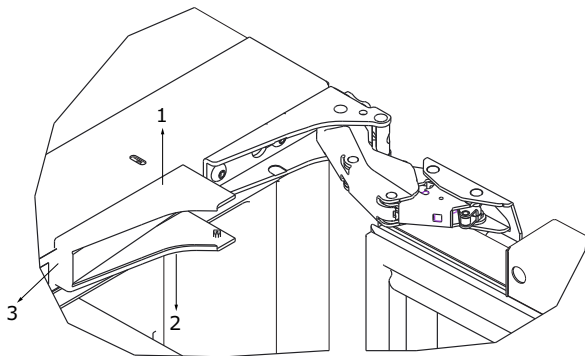

3. Once cover is removed, slide hinge pin into hole as shown. Pin should slide into place, stopping the door at 90°; if the pin does not go into the hole shown, hold the door less than 90° open and try again.

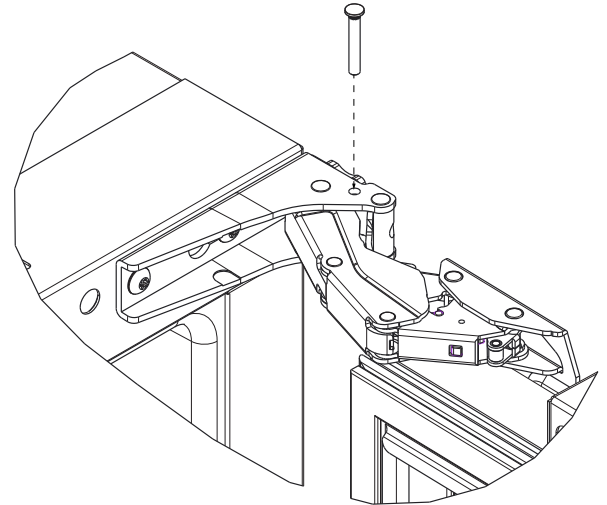

4. To fully seat the pin, tap it lightly with a hammer.
5. Carefully slide your unit back in place.

NOTICE

The pin can be removed to return the door swing back to its original 115° swing by tapping the pin out from the bottom of the hinge.

CLOSER

The door hinge has a self-closing feature that engages when the door is open approximately 6" (150 mm) (about 25°).

Door Adjustments

DOOR ALIGNMENT AND ADJUSTMENT

Align and adjust the door if it is not level or is not sealing properly. If the door is not sealed, the unit may not cool properly, or excessive frost or condensation may form in the interior.

NOTICE

Properly aligned, the door's gasket should be firmly in contact with the cabinet all the way around the door (no gaps). Carefully examine the door's gasket to ensure that it is firmly in contact with the cabinet. Also make sure the door gasket is not pinched on the hinge side of the door.



Do not attempt to use the door to raise or pivot your unit. This would put excessive stress on the hinge system.

Alignment and Adjustment Procedure

1. Open door and remove gasket near the hinges.
2. Using a T-25 Torx Bit, loosen each pair of Torx head screws on both the upper and lower hinge plates.
3. Square and align door as necessary.
4. Tighten Torx head screws on hinge.
5. Reinstall gasket into the channel starting at the corner.

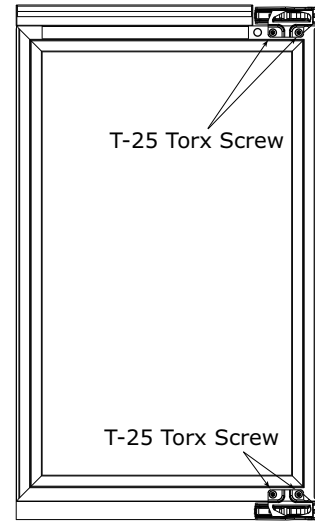

REVERSING THE DOOR

1. Open door.
2. Remove top hinge cover by lifting top and bottom flaps and slide inwards. Repeat on bottom hinge.

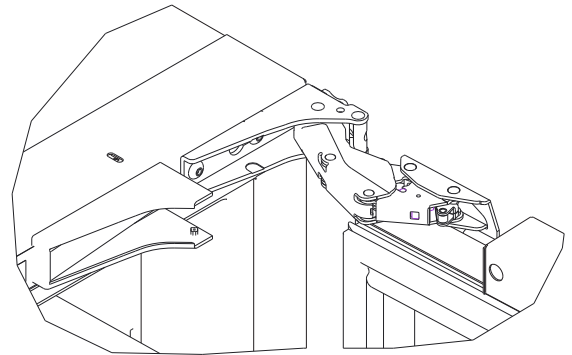

- Using T-25 Torx bit loosen screw #1 and remove screw #2 on top and bottom hinge. Slide and remove the door from unit. Completely remove screw #1 on top and bottom.

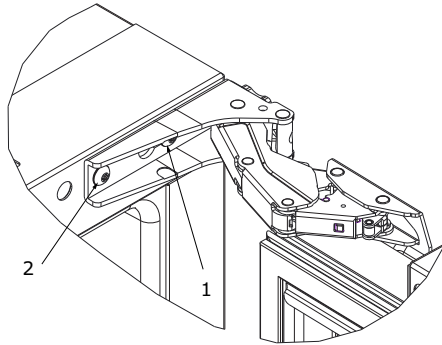

- Remove caps from screw heads on opposite side (2 on top and 2 on bottom). Using #2 Phillips bit remove the 4 underlying screws. Reinstall the screws and caps on the opposite side.
- Partially install screw #1 in the outer most holes on top and bottom. Rotate door 180°, align hinge over screw #1 and slide/seat into position. Reinstall screw #2 on top and bottom. Tighten both screws and install hinge cover.

Align and adjust the door:

Align and adjust the door (see DOOR ALIGNMENT AND ADJUSTMENT).

First Use

All U-Line controls are preset at the factory. Initial startup requires no adjustments.

NOTICE

U-Line recommends discarding the ice produced during the first two to three hours of operation to avoid possible dirt or scale that may dislodge from the water line.

When plugged in, the unit will begin operating under the factory default setting. Follow the on screen prompt for language selection and temperature units.







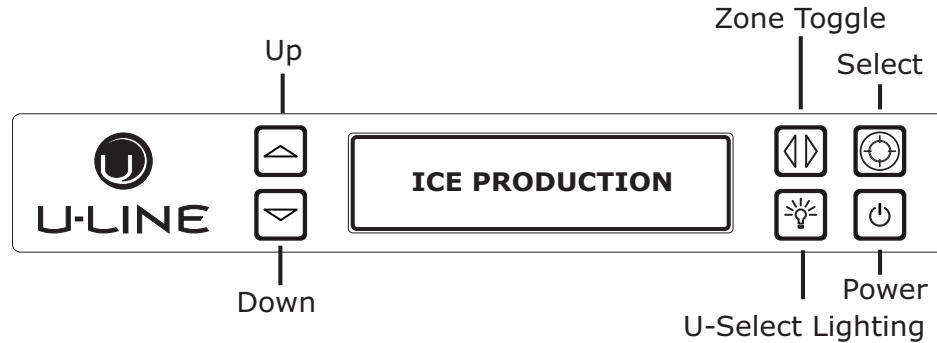





To turn the unit off, press  and hold for 5 seconds and release. The display will show a countdown to switching the unit off.

To power your unit on, simply press  and the unit will immediately switch on.

Control Operation



CONTROL FUNCTION GUIDE

FUNCTION	COMMAND	DISPLAY/OPTIONS
OFF	Press  and hold	Display will count down from 5 to off.
ON	Press  and release	Unit will come on immediately.
Adjust lighting	Press  to adjust lighting	Press  or  to set low, medium or high.
Customer menu	Press  and hold for 5 seconds	Press  or  to scroll through menu.
Service menu	Press  or  and hold for 5 seconds	Press  or  to scroll through menu.

U-SELECT® CONTROL



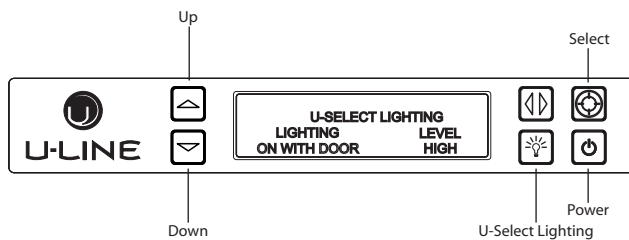

Digital Display

The 3000 Series units are controlled by a feature rich, advanced OLED display control unit. The control panel allows adjustment to temperature set point, access to Energy Saver Mode, internal temperature readings, and many other features.

U-Select Lighting



1. To begin, press  to enter the lighting menu.





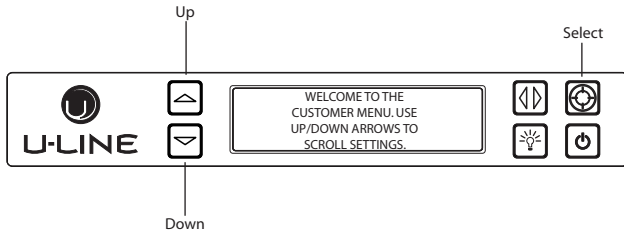

2. Press  or  to cycle through each available brightness setting (Low, Medium or High).
3. Press  to cycle through each available timer setting. Selections include "On With Door", "On 3 Hours", "On 6 Hours", or "On 24 Hours".
4. To exit, press  or simply wait for the menu to time out.

CUSTOMER MENU

The 3000 Series of U-Line undercounter refrigeration appliances contains a feature rich customer menu. The Customer Menu allows access to a series of advanced features including Energy Saver Mode, Sabbath Mode, actual temperature readings as well as a method to restore factory defaults.

3000 Series - Customer Menu





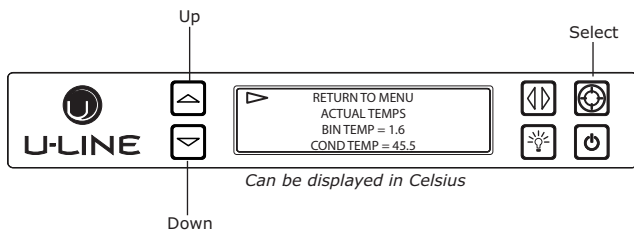

1. To access the Customer Menu hold  for 5 seconds.
2. Press  or  to scroll through available selections.
3. Press  to enter selected sub-menu.
4. To exit Customer Menu, press  to scroll to the bottom of the display and press  to select "Exit".

Actual Temps







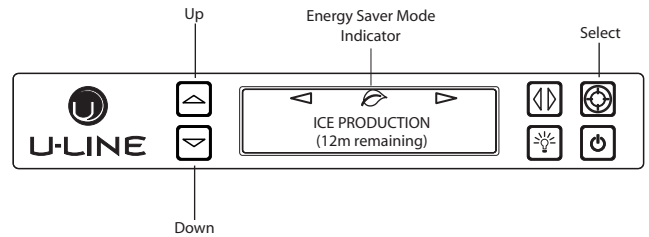

The Actual Temps option displays the actual temperature of the ice bin and condenser, as well as ambient temperature.

1. To view actual temperature, press  and select "Actual Temps" from the Customer Menu.
2. Press  or  to scroll through available information.
3. To return to the Customer Menu, press  and select "Return to Menu".

Energy Saver Mode





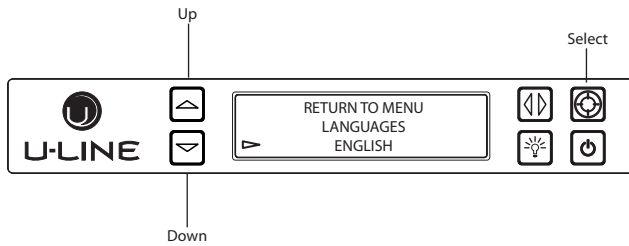

Energy Saver mode reduces overall energy consumption by reducing the amount of ice stored in the bin, along with decreasing the lighting.

1. To enter Energy Saver Mode, first select Energy Saver from the Customer Menu.
2. Press  to select "Off" in the menu.
3. Press .
4. Press  or  to change the selection from Off to On.
5. Press  to confirm your selection.
6. To return to the Customer Menu, press  and select "Return to Menu".
7. To cancel Energy Saver Mode simply return to the Customer Menu, select Energy Saver and change "On" to "Off".

Languages



The U-Line 3000 Series of models supports a number of display languages including English, Spanish, French, German and Italian.

1. To change display language select Languages from the Customer Menu.
2. Press  to select "English".
3. Press . "English" will begin to flash.
4. Press  or  to cycle through the available languages.
5. Press  to confirm your choice.



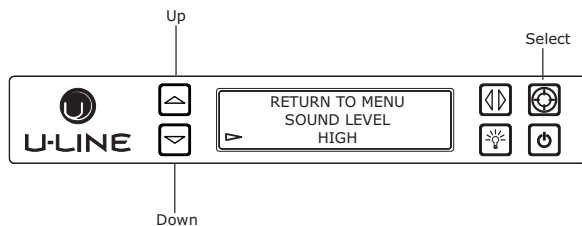

Sound Level



Audible alarms and alert tones support four different Sound Level settings, High, Medium, Low, and Off.

To select a new tone level, enter the Sound Level Menu from the Customer Menu.

1. Press  or  to select the current sound level.



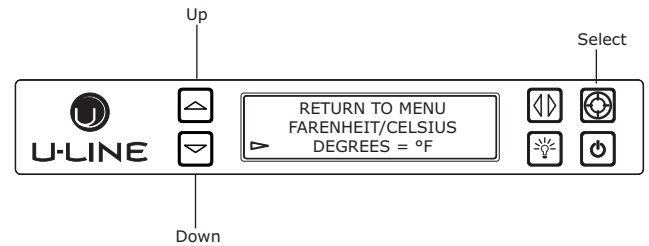

2. Press . The current setting will begin to flash.
3. Press  or  to select a different level.
4. Press  to confirm your choice.

Fahrenheit / Celsius



Temperature and set point information can be displayed in either Fahrenheit or Celsius.

To change from Fahrenheit to Celsius enter the Fahrenheit / Celsius Menu from within the Customer Menu.

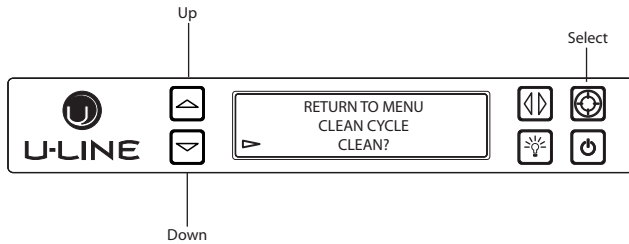

1. Press  to select "Degrees".
2. Press . The selection will begin to flash.
3. Press  or  to select between °F (Fahrenheit) or °C (Celsius).
4. Press  to confirm your choice.

Clean Cycle



A clean cycle can be initiated through this menu. Once the cleaning cycle starts, the cycle cannot be stopped until complete.

To initiate a clean cycle, select "Clean Cycle" from the Customer Menu. Please refer to CLEANING section regarding proper cleaning procedure.

1. Press  to select "Clean Cycle".
2. Press . The clean cycle will now begin.
3. Refer to CLEANING section regarding proper cleaning procedure.

Silent Mode

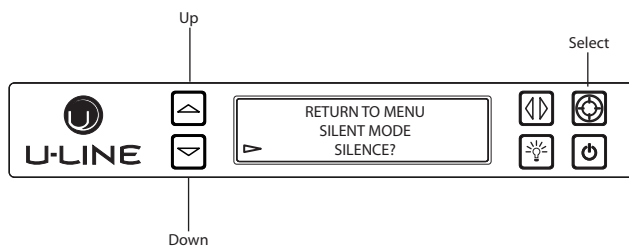



Users can halt ice production for 3 hours with an option called "Silent Mode" in the Customer Menu. Silent Mode will begin once the current ice making cycle is complete. After 3 hours in Silent Mode, normal ice production will continue.



NOTE: Silent Mode will not silence any alerts.

To initiate Silent Mode, enter Silent Mode Menu from within the Customer Menu.

To activate Silent Mode:

1. Press  to select "Silence?".
2. Press . Silent Mode will now begin.

To cancel Silent Mode:

1. Press  to select "Cancel?".
2. Press . Silent Mode will end.



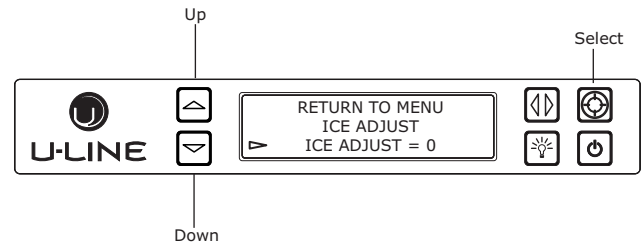

Ice Adjust



The Ice Adjust option adjusts ice thickness by adding or subtracting up to 5 minutes of ice production.



To change the ice thickness, enter the Ice Adjust Menu from within the Customer Menu.

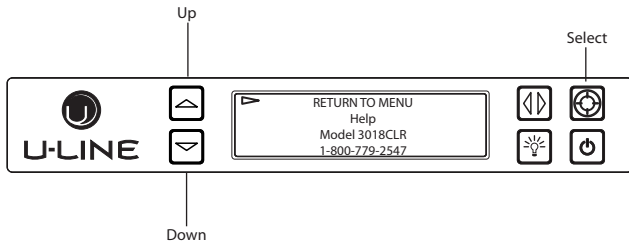

To adjust thickness:

1. Press  to select "Ice Adjust".
2. Press . The selection will begin to flash.
3. Press  to make the ice thicker or  to make the ice thinner.
4. Press  to confirm your choice.

Help



To access the Help Menu, select “Help” from the Customer Menu. Press  or  to scroll through available information.

To return to the Customer Menu, press  to select “Return to Menu” and press  to confirm.

Ice

ICE CUBE THICKNESS ADJUSTMENT

NOTICE

Ice thickness adjustment should only be made one increment at a time. Allow ice maker production to stabilize for 24 hours before rechecking ice thickness.

Ice is produced in layers resulting in a clear cube. Ice in bin may develop surface frost which disappears when cube is placed in liquid.

Ice cubes in any given batch will vary, so it is necessary to choose cubes from the sample area for comparison when making adjustments.

The ice cube thickness is factory set for best overall performance. The factory setting "0" is designed to maintain an ice bridge of approximately 1/16" to 1/8" (1.6 mm to 3.2 mm) under normal conditions, resulting in a dimple of approximately 1/4" to 1/2" (6.4 mm to 12.7 mm) in depth. A fuller cube with less of a dimple results in a thicker ice bridge. As the ice bridge thickens, the tendency for the cubes to stay together as a slab increases. A bridge thicker than 1/8" (3.2 mm) may cause cubes to overfill the ice bucket.

32 ice cubes are formed on a 4 x 8 slab during each cycle. Each cycle takes approximately 15-20 minutes at the default cube thickness (0).



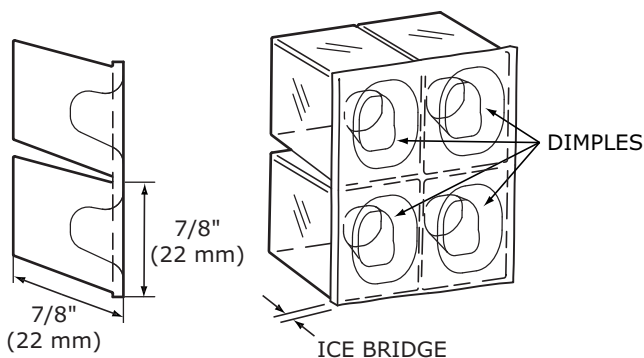
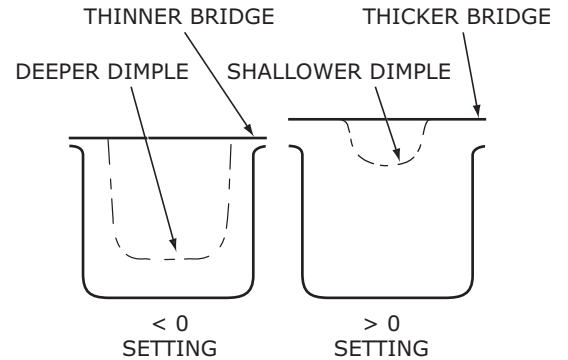
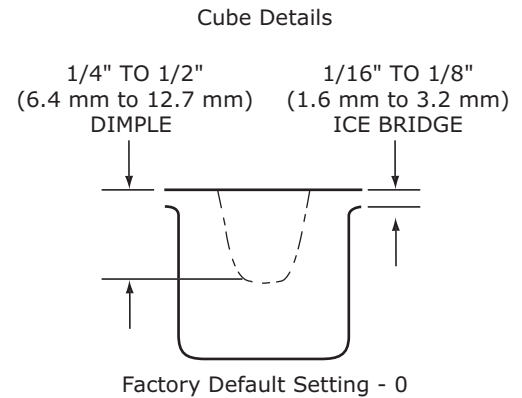

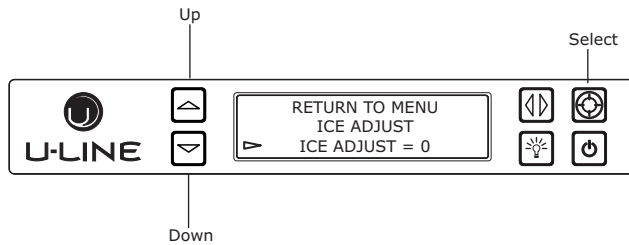

Your clear ice machine is pre-set to produce ice between the optimal dimensions illustrated below:



ICE ADJUST



Adjust ice thickness as follows:

1. Press  and  and hold for 5 seconds to enter the Customer Menu.
2. Press  to select "Ice Adjust".
3. Press . The selection will begin to flash.
4. Press  to make the ice thicker or  to make the ice thinner. Press  to confirm your choice.

Sabbath Mode

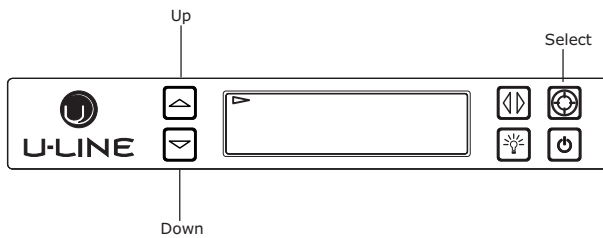
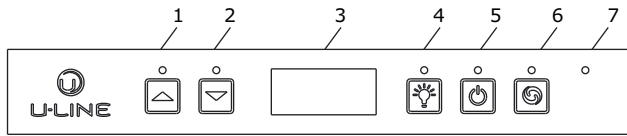

U-Line Clear Ice Machine models are Star-K certified and can be used during the Sabbath. View a full list of Star-K certified U-Line units at www.star-k.org.

To prepare the unit for the Sabbath:

1. Press  and hold the until the unit turns off.
2. No new ice will form when the unit is off, but previously made ice will still be accessible/present for over 24 hours. Pump equipped models will continue to remove water as needed even if the unit is off.

Sabbath Mode remains active until  is pressed again and the unit turns on.

Airflow and Product Loading

NOTICE

The unit requires proper airflow to perform at its highest efficiency. Do not block the front grille at any time, or the unit will not perform as expected. Do not install the unit behind a door.

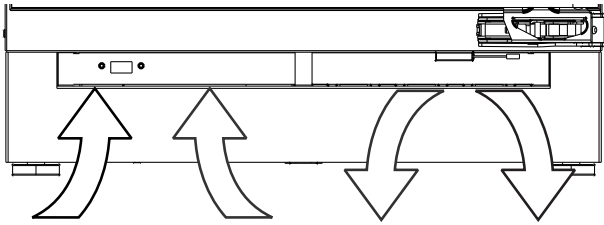

Cleaning

EXTERIOR CLEANING

Stainless Models

Stainless door panels and handles can discolor when exposed to chlorine gas, pool chemicals, saltwater or cleaners with bleach.

Keep your stainless unit looking new by cleaning with a good quality all-in-one stainless steel cleaner and polish monthly. For best results use Claire® Stainless Steel Polish and Cleaner. Comparable products are acceptable. Frequent cleaning will remove surface contamination that could lead to rust. Some installations may require cleaning weekly.

Do not clean with steel wool pads.

Do not use stainless steel cleaners or polishes on any glass surfaces.

Clean any glass surfaces with a non-chlorine glass cleaner.

Do not use cleaners not specifically intended for stainless steel on stainless surfaces (this includes glass, tile and counter cleaners).

If any surface discoloring or rusting appears, clean it quickly with Bon-Ami® or Barkeepers Friend Cleanser® and a nonabrasive cloth. Always clean with the grain. Always finish with Claire® Stainless Steel Polish and Cleaner or comparable product to prevent further problems.

Using abrasive pads such as ScotchBrite™ will cause the graining in the stainless steel to become blurred.

Rust not cleaned up promptly can penetrate the surface of the stainless steel and complete removal of the rust may not be possible.

Integrated Models

To clean integrated panels, use household cleaner per the cabinet manufacturer's recommendations.

INTERIOR CLEANING

Disconnect electric current to the unit.

Clean the interior and all removed components using a mild nonabrasive detergent and warm water solution applied with a soft sponge or non-abrasive cloth.

Rinse the interior using a soft sponge and clean water.

Do not use any solvent-based or abrasive cleaners. These types of cleaners may transfer taste to the interior products and damage or discolor the lining.

CLEAR ICE MAKER CLEANING CYCLE

The 3000 series ice maker is equipped with an automatic clean alert function. Cleaning cycles should be run as notified. Otherwise, to maintain operational efficiency, the unit should be cleaned every three months. Depending on water conditions, more frequent cleaning may be necessary. If the ice maker requires more frequent cleaning, consult a plumber to test the water quality and recommend appropriate treatment.



Wear rubber gloves and safety goggles and/or face shield when handling Ice Machine Cleaner.

NOTICE

Discard all ice produced in the first harvest.

Should electricity to the unit be interrupted during the self-clean cycle, the complete cleaning cycle will repeat after electricity is restored.

Use only U-Line Ice Machine Cleaner (Part No. 37050), available from your dealer or direct from your local parts distributor. To locate a parts distributor near you, visit www.u-line.com. It is a violation of federal law to use this solution in a manner inconsistent with its labeling. Use of any other cleaner can ruin the finish of the evaporator and will void the warranty. Read and understand all labels printed on the package before use.

U-Line Ice Machine Cleaner is used to remove lime scale and other mineral deposits. Refer to the following steps to initiate the self-cleaning cycle.



Never use anything to force ice from the evaporator. Damage may result.

1. Switch the ice maker off and allow any ice to melt off of the evaporator.

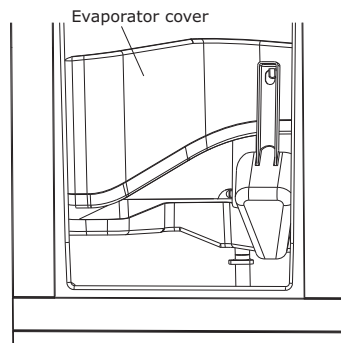

2. Remove all ice from the storage bin.
3. Remove evaporator cover.

4. Remove the standpipe by lifting it up while using a slight back and forth motion to loosen it from the drain hole. The water in the reservoir will flow down the drain.

5. Re-install the standpipe into the water trough.

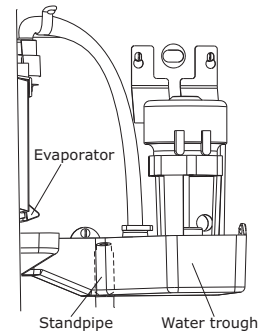

6. Clean the Interior Bin as follows:

- Dilute one packet of CLR cleaner into two quarts of water.
- Using a sponge or cloth, clean interior of ice bin, tubing and door. This cleaner will remove all mineral deposits and other contaminants from the surfaces.
- Using a bottle brush, clean out the trough drain tube and pump tubing where needed.

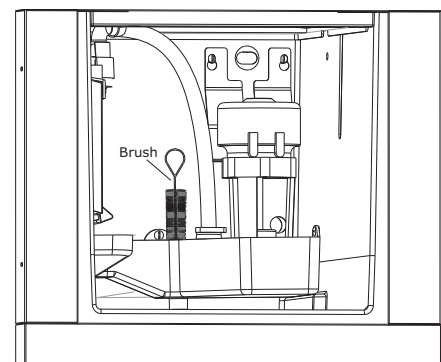

7. Switch on unit on by pressing .

8. Place unit in cleaning mode. See CONTROL OPERATION for more detail.

9. When water begins flowing over the evaporator (approximately 3 minutes), pour 1 packet of CLR cleaner into the water trough. The cleaning process will last approximately 45 minutes.

10. Dilute 1 tablespoon (15 ml) bleach in 1 gallon (3.8 liters) of warm water. Apply this solution to the entire inside of the storage area. Then rinse thoroughly with water.

The unit will resume operation approximately 15 minutes after the automated cleaning process is completed. The water fill valve will energize, fill the water reservoir, and shut-off after three minutes. The compressor begins to operate and water flows over the evaporator assembly (ice mold). Initially, the water flow may not be uniform, causing uneven sized cubes or water to spill into the ice storage bin. This is a normal situation that will correct itself within the first 24 hours of operation.

NOTICE

Discard all ice produced in the first harvest.

Should power to the unit be interrupted during the self-clean cycle, the complete cleaning cycle will repeat after power is restored.

REFRESH KIT

Due to variations in water quality or inadequate maintenance your unit may become excessively coated in lime scale or calcium. U-Line offers a cost effective refresh kit which replaces many interior components and will return your unit to like new condition. Refresh kits may be ordered from your local distributor and installed by your local service company. For information on your local distributor or service company please visit www.u-line.com.

Cleaning Condenser

INTERVAL - EVERY SIX MONTHS

To maintain operational efficiency, keep the front grille (plinth strip/base fascia) free of dust and lint, and clean the condenser when necessary. Depending on environmental conditions, more or less frequent cleaning may be necessary.



WARNING

Disconnect electric current to the unit before cleaning the condenser.

NOTICE

DO NOT use any type of cleaner on the condenser unit. Condenser may be cleaned using a vacuum, soft brush or compressed air.

1. Remove the grille (plinth strip/base fascia). (See GRILLE-PLINTH INSTALLATION).
2. Clean the condenser coil using a soft brush or vacuum cleaner.
3. Install the grille (plinth strip/base fascia).

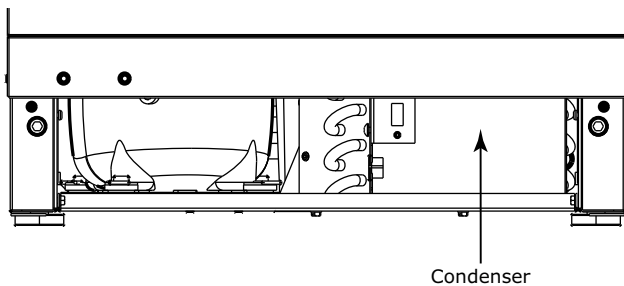

Extended Non-Use

VACATION/HOLIDAY, PROLONGED SHUTDOWN

The following steps are recommended for periods of extended non-use:

1. Remove all consumable content from the unit.
2. Disconnect the power cord from its outlet/socket and leave it disconnected until the unit is returned to service.
3. Turn off the water supply.
4. If ice is on the evaporator, allow ice to thaw naturally.
5. Clean and dry the interior of the cabinet. Ensure all water has been removed from the unit.
6. Disconnect the water and drain line (if applicable) making sure all water is removed from the lines.
7. The door must remain open to prevent formation of mold and mildew. Open door a minimum of 2" (50 mm) to provide the necessary ventilation.

WINTERIZATION

If the unit will be exposed to temperatures of 40°F (5°C) or less, the steps above must be followed. In addition, P60 drain pumps in clear ice machines must be drained according to the following procedure:

1. Remove the drain pump from the ice machine.
2. Drain the water in the pump's reservoir by turning the pump upside down and allowing the water to drain through the pump's inlet and vent tube fittings.
3. After water is drained, reinstall the drain pump and reattach all connections.

For questions regarding winterization, please call U-Line at +1.800.779.2547.



Damage caused by freezing temperatures is not covered by the warranty.

Do not put anti-freeze in your unit.

Troubleshooting

BEFORE CALLING FOR SERVICE

If you think your U-Line product is malfunctioning, read the CONTROL OPERATION section to clearly understand the function of the control.

If the problem persists, read the NORMAL OPERATING SOUNDS and TROUBLESHOOTING GUIDE sections below to help you quickly identify common problems and possible causes and remedies. Most often, this will resolve the problem without the need to call for service.

IF SERVICE IS REQUIRED

If you do not understand a troubleshooting remedy, or your product needs service, contact U-Line Corporation directly at +1.800.779.2547.

When you call, you will need your product Model and Serial Numbers. This information appears on the Model and Serial number plate located on the interior of your product or can be accessed through "Help" in the Customer Menu.

NORMAL OPERATING SOUNDS

All models incorporate rigid foam insulated cabinets to provide high thermal efficiency and maximum sound reduction for its internal working components. Despite this technology, your model may make sounds that are unfamiliar.

Normal operating sounds may be more noticeable because of the unit's environment. Hard surfaces such as cabinets, wood, vinyl or tiled floors and paneled walls have a tendency to reflect normal appliance operating noises.

Listed below are common refrigeration components with a brief description of the normal operating sounds they make. NOTE: Your product may not contain all the components listed.

- Compressor: The compressor makes a hum or pulsing sound that may be heard when it operates.
- Evaporator: Refrigerant flowing through an evaporator may sound like boiling liquid.
- Condenser Fan: Air moving through a condenser may be heard.
- Solenoid Valves: An occasional clicking sound may be heard as solenoid valves are operated.

TROUBLESHOOTING GUIDE



ELECTROCUTION HAZARD. Never attempt to repair or perform maintenance on the unit before disconnecting the main electrical power.

Troubleshooting - What to check when problems occur:

Problem	Possible Cause and Remedy
Digital Display and Light Do Not Work.	Ensure power is connected to the unit. If the unit is cooling, it may be in Sabbath mode.
Interior Light Does Not Illuminate.	If the unit is cooling, it may be in Sabbath mode or manually set to off.
Light Remains on When Door Is Closed.	Lighting may be set to on; reset to with door.
Unit Develops Condensation on External Surfaces.	The unit is exposed to excessive humidity. Moisture will dissipate as humidity levels decrease.
Digital Display Functions, But Unit Does Not Produce Ice.	Ensure the unit is not in "Showroom Mode." Momentarily unplug or interrupt power supply to the unit.
Digital Display Shows an Error.	"Door" indicates the door may be opened too long. Ensure the door is closing properly. For other error codes contact U-Line Customer Service.
Ice Is Too Thick/Thin	Ice Adjust not set to user's preference. Adjust ice thickness via Customer Menu.
Poor Ice Quality	Unit may not be level. Check if unit is level. Ice maker may be dirty. Clean ice maker.

Problem	Possible Cause and Remedy
No Ice Production	Ensure water is being supplied to the unit. Verify the ice making unit is turned on.
Not Enough Ice	Ensure the condenser coil is clean and free of any dirt or lint buildup.
Water in Bin	Ensure the unit is plugged in. Check if the drain is restricted. Ensure drain is free of foreign debris and hose is not kinked or twisted.
Hear Running Water	During ice creation, the water running over the evaporator may be heard.
Hear Ice Falling	After each harvest, ice will fall into the bin.

ERROR NOTIFICATION

The 3000 model series continuously monitors a series of inputs and parameters to ensure proper and efficient operation of your unit. Should the system detect a fault, an error notification will be displayed on the user interface. See below for a list of errors.

ID	Description	Solution
No Comm	Unit lost communication to the display.	Disconnect and reconnect power to unit. Contact Customer Care if persistent.
Zone T Open	Left or right zone thermistor circuit open.	Contact Customer Care.
Amb Thrm Open	Ambient thermistor circuit open.	Contact Customer Care.
Zone T Short	Left or right zone thermistor circuit shorted.	Contact Customer Care.

Wire Diagram

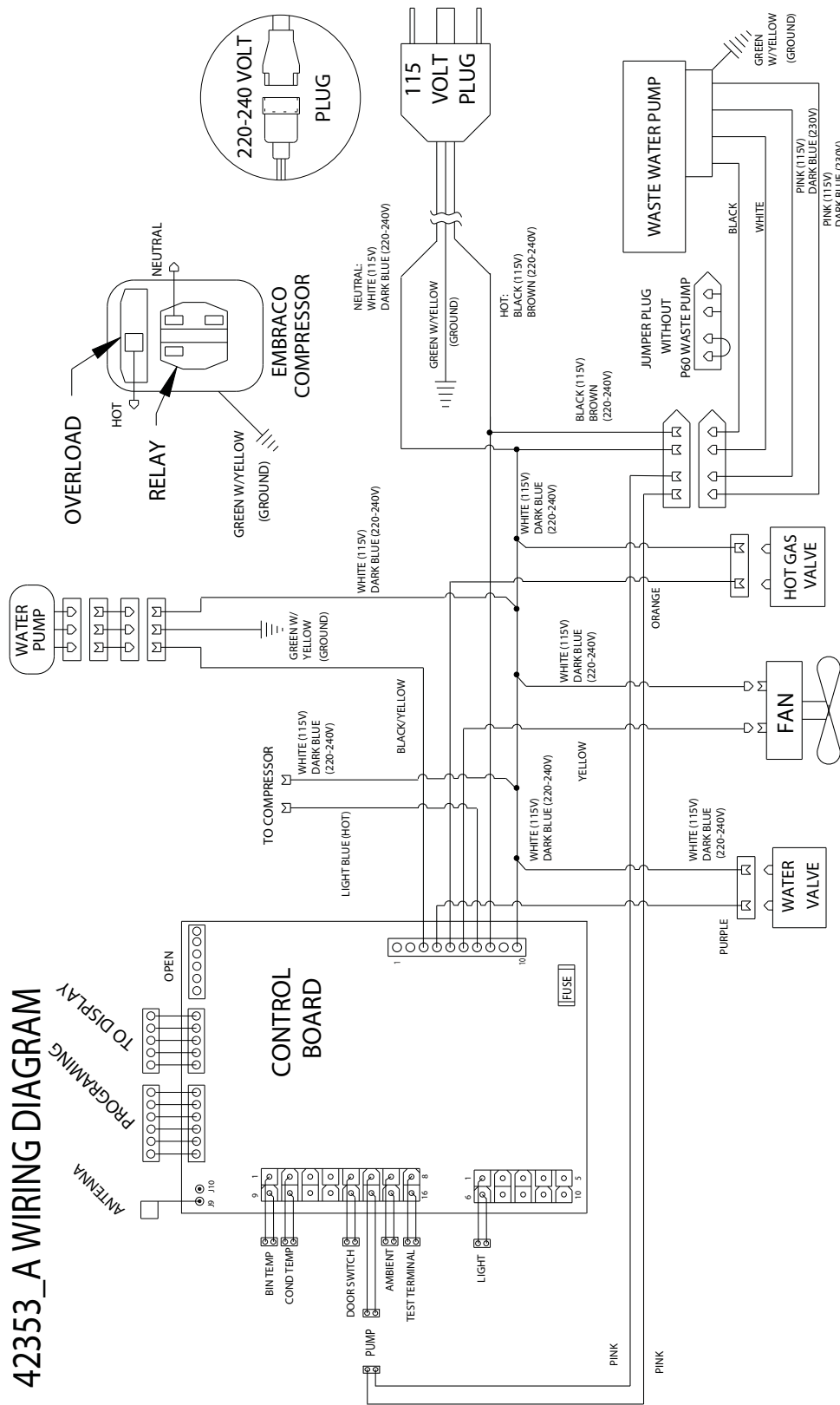

Product Liability

Field service technicians are authorized to make an initial assessment in the event of reported damages. If there are any questions about the process involved, the technician should call U-Line for further explanation.

While inspecting for defects or installation issues, photos should be taken to document any damages or issues found.

During the assessment, if the service technician is able to find the source of the damage and it can be resolved by replacement of a part, the servicer is authorized to replace the part in question. The part that caused the damage must be returned to U-Line in its entirety. The part must be clearly labeled with the serial number of the unit it was removed from, the date, and the servicer who removed the part.

If the service technician determines the damage is the result of installation issues (water connection/drain, etc.), the consumer would be notified and the issues shall be resolved at the direction of the consumer.

If damage is evident and the service technician is unable to find the source, U-Line must be contacted at 1-800-799-2547 for further direction

8900 N. 55th Street • Milwaukee, WI 53223
T: +1.414.354.0300 • F: +1.414.354.354.5696
Website: www.u-line.com

**Right product. Right place.
Right temperature Since 1962.**

Warranty Claims

The following information defines the parameters for filing a warranty claim:

- Valid serial number needed
- Valid model number needed
- Narda (or equivalent) form or submitted online at www.u-line.com
- 60 day submittal deadline from date of completed service
- Only one repair or unit per warranty claim
- Refrigerant should be labeled and included on the labor submittal
- Door and water level adjustments are covered 30 days from install date.

Serial Number Requirements:

14 30911 12 XXXX
Year Month

A typical serial number is shown above. The first two digits of the first segment, 14, represents the production year. The number between the dashes, 12, represents the production month. In most cases, warranty status can be verified by the production date information within the serial number.

- Alternatively, a Proof of Purchase (or equivalent) may be submitted with the warranty claim to document

warranty status. We also accept the following information to verify warranty status:

- New Construction Occupancy Documents
- Closing Paperwork
- Final Billing – Remodel

Noting all of the following on the warranty claim will be considered proof of purchase, hard copy will not be required:

- Name of the selling Dealer
- Date of purchase/installation
- Order or Invoice number (if available)
- Description of document reviewed (i.e. store receipt, closing paperwork, etc)

Parts and labor claims are paid separately. Indicate part numbers and description for parts used in the warranty repair. Include the purchase invoice and name of the parts supplier used to procure the parts.

Parts

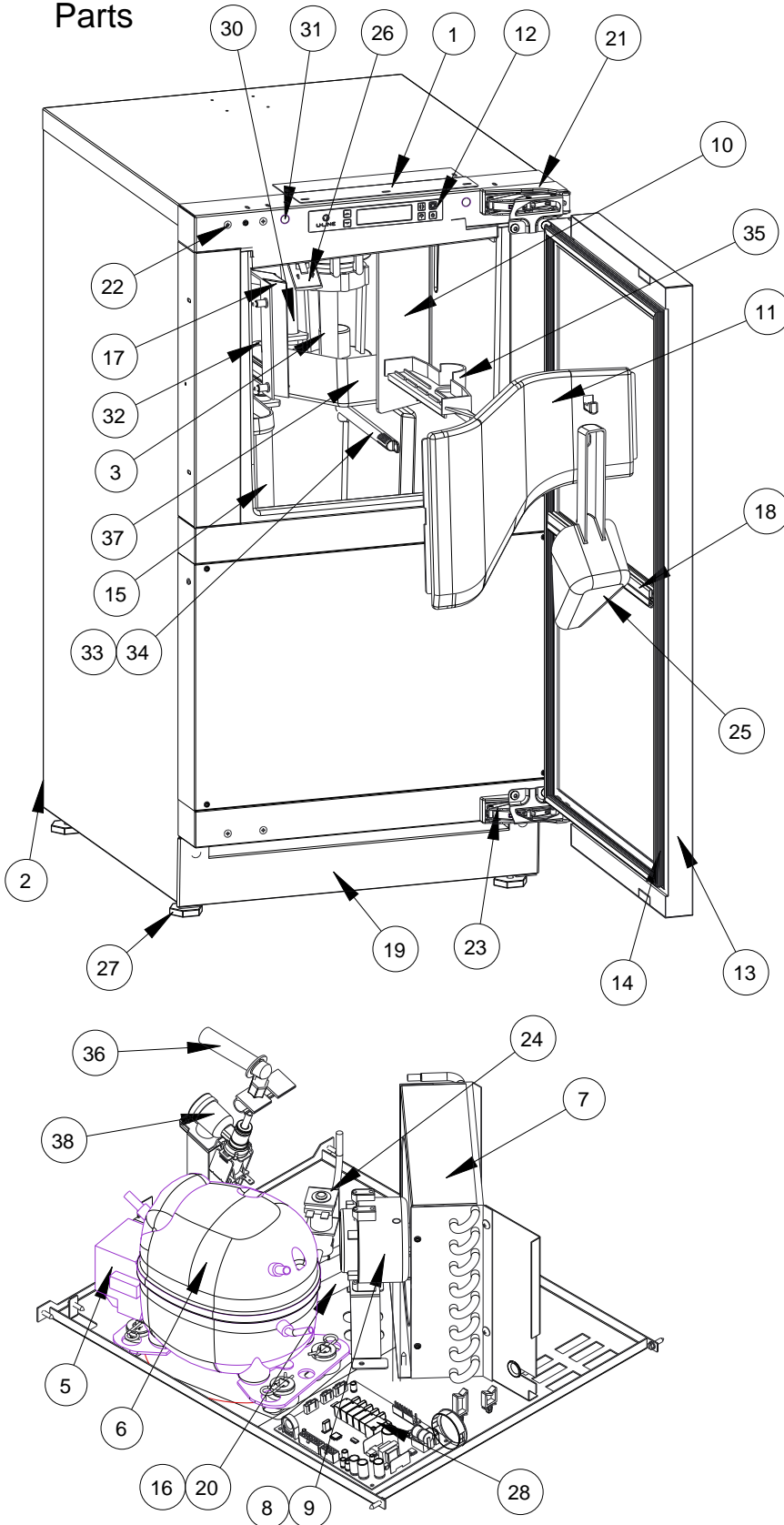

U-3045CLRINT-00B

Item	Description	U-Line P/N
1	Anti tip brackets w/screws	80-54012-00
2	Back panel	80-54083-00
3	Circulation pump	80-54064-00
4	Cleaner	80-54081-00
5	Compressor electricals only	80-54071-00
6	Compressor w/electricals	80-54069-00
7	Condenser	80-54079-00
8	Condenser fan	80-54065-00
9	Condenser fan blade	80-54066-00
10	Cover pump, black	80-54073-00
11	Cover w/ hook, black	80-54072-00
12	Display module	80-54032-00
13	Door assembly w/o hinges	80-54062-00
14	Door gasket	80-54003-00
15	Drain tube, clear	80-54074-00
16	Drier	80-54055-00
17	Evaporator	80-54063-00
18	Gasket Horizontal	80-54061-00
19	Grille w/ screws	80-54031-00
20	Hi temp thermistor	80-54070-00
21	Hinge covers (2 pcs)	80-54001-00
22	Hinge mounting hole covers	80-54024-00
23	Hinges (2) w/screws and covers	80-54013-00
24	Hot gas valve and coil	80-54009-00
25	Ice scoop, clear	80-54080-00
26	LED light strip and cover assy	80-54000-00
27	Leg Levelers (4)	80-54019-00
28	Main board (no wires or case)	80-54008-00
29	Packaging	80-54082-00
30	Preformed dispersion tube	80-54128-00
31	Reed switch	80-54004-00
32	Stand pipe	80-54077-00
33	Thermistor (1 piece)	80-54006-00
34	Thermistor cover and pin	80-54023-00
35	Water dispersing receptacle	80-54078-00
36	Water line assembly	80-54068-00
37	Water trough, black	80-54075-00
38	Water valve assembly	80-54067-00

Ordering Replacement Parts

If you have a purchasing account, please utilize our service website to order parts.

Orders may also be placed by Fax or phone. See our contact information below:

www.U-LineService.com (with service login)

FAX Number: +1.414.354.5696

Phone Number: +1.800.779.2547

NOTICE

Use only genuine U-Line replacement parts. The use of non-U-Line parts can reduce speed of ice production, cause water to overflow from ice maker mold, damage the unit, and void the warranty.

Warranty parts will be shipped at no charge after U-Line confirms warranty status. Please provide the model, serial number, part number and part description. Some parts will require color or voltage information.

If U-Line requires the return of original parts, we will inform you when the parts order is taken. This requirement will be noted on your packing list. A prepaid shipping label will be included with the replacement part. Please enclose a copy of the parts packing list and any labor claims with your return. Please be sure the model and serial numbers are legible on the paperwork. Tag the part with the reported defect.

When ordering a non-warranty part, you will need an open account and tax exemption on file at U-Line. Another option would be to visit www.u-line.com to locate an authorized parts distributor in your area.

System Diagnosis Guide

REFRIGERATION SYSTEM DIAGNOSIS GUIDE

System Condition	Suction Pressure	Suction Line	Compressor Discharge	Condenser	Capillary Tube	Evaporator	Wattage
Normal	Normal	Slightly below room temperature	Very hot	Very hot	Warm	Cold	Normal
Overcharge	Higher than normal	Very cold may frost heavily	Slightly warm to hot	Hot to warm	Cool	Cold	Higher than normal
Undercharge	Lower than normal	Warm-near room temperature	Hot	Warm	Warm	Extremely cold near inlet - Outlet below room temperature	Lower than normal
Partial Restriction	Somewhat lower than normal vacuum	Warm - near room temperature	Very hot	Top passes warm - Lower passes cool (near room temperature) due to liquid	Room temperature (cool) or colder	Extremely cold near inlet - Outlet below room temperature backing up	Lower than normal
Complete Restriction	In deep vacuum	Room temperature (cool)	Room temperature (cool)	Room temperature (cool)	Room temperature (cool)	No refrigeration	Lower than normal
No Gas	0 PSIG to 25"	Room temperature (cool)	Cool to hot	Room temperature (cool)	Room temperature (cool)	No refrigeration	Lower than normal

Compressor Specifications

⚠ DANGER

Electrocution can cause death or serious injury. Burns from hot or cold surfaces can cause serious injury. Take precautions when servicing this unit.

Disconnect the power source.

Do not stand in standing water when working around electrical appliances.

Make sure the surfaces you touch are not hot or frozen.

Do not touch a bare circuit board unless you are wearing an anti-static wrist strap that is grounded to an electrical ground or grounded water pipe.

Handle circuit boards carefully and avoid touching components.

To measure the start winding resistance, measure across the C and S pins.

To measure the run winding resistance, measure across the C and R pins.

Also check S to R and you should get the sum of the run and start windings.

To ensure the windings are not shorted, check the S and R to ground.

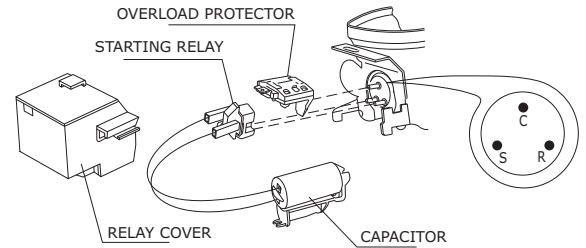

Electrical Relay and Overload Protector

	EMY70HSC
Refrigerant	R134a
Voltage	220 - 240 VAC
Frequency	50/60 Hz
Run Cap	4 μ F/300 VAC
Start Winding	23.3 Ohm at 77°F/25°C
Run Winding	13.2 Ohm at 77°F/25°C
LRA	7.1 A
FLA	0.58 A
Starting Device	8EA17C3
Overload	4TM213PFBYY-53

* All resistance readings are $\pm 10\%$

Troubleshooting - Extended

SPECIFIC ERRORS AND ISSUES

The technically advanced diagnostic capabilities of the electronic controls utilized on the 3000 series units allows for easy and thorough trouble shooting.

Navigation of the control is the key and is explained in the CONTROL OPERATION section of the manual, along with control button layout, control function descriptions, a service mode menu and service menu selection explanations.

Verification of temperature and thermistor performance can be identified by directly viewing actual temperature readings in the service mode.

Component failure issues can be identified through service mode menu selection, "Relay Toggle" Individual components can be switched on and off to check for both proper function of a specific component and also delivery of supply voltage to the components through the relays and DC outputs located on the relay/power board.

Included in this section is some diagnostic tips and as always, if additional help is required please contact the U-Line Corp, "Customer Care Facility" at +1.800.779.2547 for assistance.

NORMAL OPERATING SOUNDS

All models incorporate rigid foam insulated cabinets to provide high thermal efficiency and maximum sound reduction for its internal working components. Despite this technology, your model may make sounds that are unfamiliar.

Normal operating sounds may be more noticeable because of the unit's environment. Hard surfaces such as cabinets, wood, vinyl or tiled floors and paneled walls have a tendency to reflect normal appliance operating noises.

Listed below are common refrigeration components with a brief description of the normal operating sounds they make. NOTE: Your product may not contain all the components listed.

- Compressor: The compressor makes a hum or pulsing sound that may be heard when it operates.
- Evaporator: Refrigerant flowing through an evaporator may sound like boiling liquid.
- Condenser Fan: Air moving through a condenser may be heard.
- Automatic Defrost Drain Pan: Water may be heard dripping or running into the drain pan when the unit is in the defrost cycle.
- Solenoid Valves: An occasional clicking sound may be heard as solenoid valves are operated.

TROUBLESHOOTING GUIDE

Concern	Potential Causes	Suggested Remedy
No Display or Interior Lights	Unit may be in Sabbath mode	Hold  for 5 seconds to turn off Sabbath mode, test the door switch circuit
No Interior Light	Light may be set to OFF Check LED strip for power Defective door switch	Use component testing in service mode and test light circuit, manually test door switch
Condensation on exterior of unit	Is unit exposed to high humidity or high ambient temps?	Moisture will dissipate as ambient temperature and humidity levels fall. Keep exterior of unit well polished to protect surface.
No Ice Production	Is unit level, is the unit getting water, is circulation pump working?	Monitor freeze cycle to assure proper water distribution over evaporator. Go to component testing and turn off fill valve, level unit if needed.
Low Ice Production	Dirty evaporator, dirty condenser, faulty bin thermistor	Clean the evaporator using U-Line cleaner, clean the condenser coil if needed, check bin thermistor reading in service mode.
Ice Does Not Fall Off During Harvest	Dirty evaporator, unit not level, faulty hot gas valve	Clean the evaporator if needed, level unit if needed, test function of hot gas bypass valve using relay toggle in service mode.
Error Message in Digital Display	Check error log	View errors in service mode, review error and take corrective action to resolve.
Ice is Too Thick/Thin	Dirty evaporator, water starvation, faulty hot gas valve	Clean evaporator if needed, check water supply, test harvest mode, adjust ice thickness.
Standing Water in Ice Bin	Drain hose is restricted, debris in bin drain hole, failed drain pump	Make sure drain hose run is as straight as possible. Remove any kinks or tight bends, pour 1/2 gallon of water into bin to test drain.
Poor Ice Quality	Is unit level, is the evaporator dirty?	Monitor freeze mode to watch water distribution over evaporator, level unit if needed, clean evaporator if needed.

MAIN CONTROL

The main control board is very robust and is rarely the cause of system issues. It is important to fully diagnose the board for any suspected failures before attempting to remove the board for replacement or service. Follow the guidelines below to fully test and diagnose the main control.

Power Fault

If the unit does not (or seems to not) power on, follow the flow chart below to help diagnose the issue. Before beginning it is important to first verify the unit is not simply set to sabbath mode.

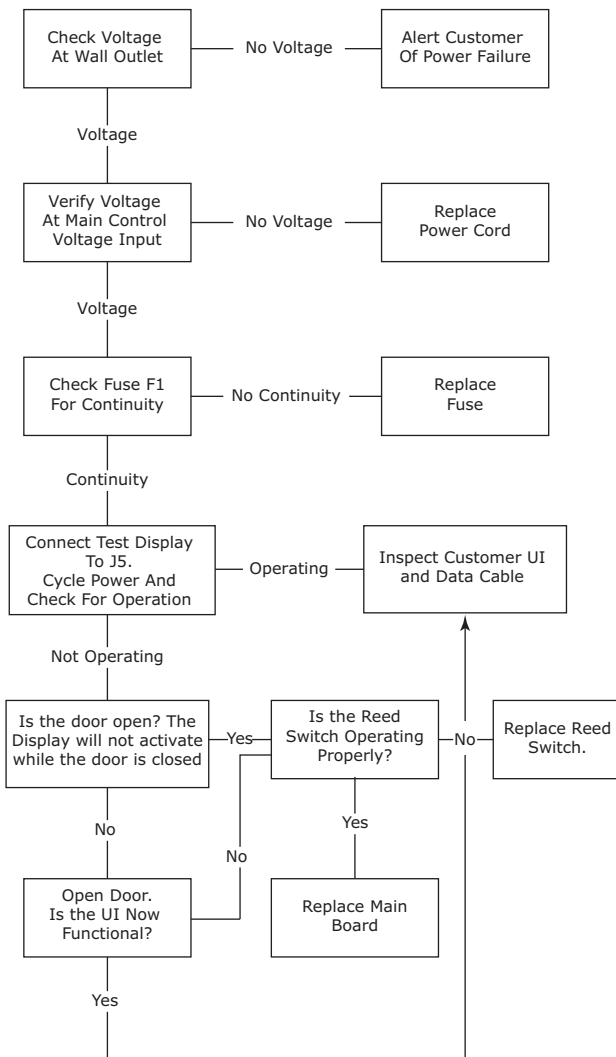

Control Operation - Service



TO ENTER THE MAIN SERVICE MENU

PRESS AND HOLD FOR 5 SECONDS  AND 

TO GO TO NEXT SUB-MENU ITEM
YOU MUST ARROW UP TO "RETURN TO MENU"

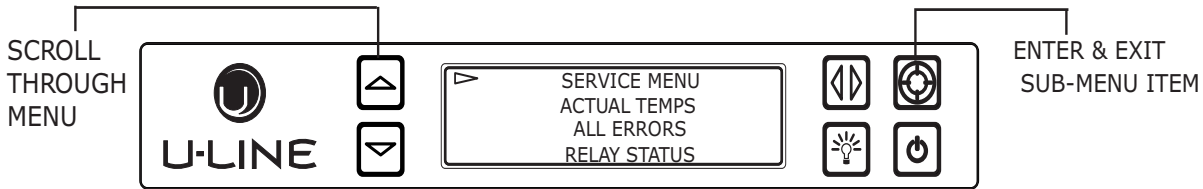

TOUCH AND RELEASE  TO RETURN TO THE MAIN MENU



ACTUAL TEMPS	SHOWS TEMPERATURES WITHOUT OFFSETS. EACH ZONE HAS AN EVAP AND AIR THERMISTOR. EACH UNIT HAS AN AMBIENT THERMISTOR	RETURN TO MENU ACTUAL TEMPS LEFT ZONE = 52° LEFT EVAP = 52°
ALL ERRORS	DISPLAYS THE NUMBER OF TIMES AN ERROR HAS OCCURRED SCROLL TO THE END TO ERASE THE ERROR CODES	RETURN TO MENU ALL ERRORS NO COMM 3 L ZONE T OPEN 0
RELAY STATUS	DISPLAYS THE CURRENT STATUS OF THE RELAYS ON THE BOARD (not all relays are used on all models)	RETURN TO MENU RELAY STATUS MULL COND DEF LVLV OFF OFF OFF ON
RELAY TOGGLE	ALLOWS THE RELAYS TO BE TOGGLED ON/OFF TO CHECK RELAY & COMPONENT YOU CAN TURN ON MULTIPLE RELAYS TO CHECK A ZONE, (COMP FAN ETC)	RETURN TO MENU RELAY TOGGLE MULL OFF COND OFF
INPUT STATUS	DISPLAYS DOOR SWITCH STATE, TEST INPUT, AND USB STATE	RETURN TO MENU INPUT STATUS LEFT DOOR CLOSED RIGHT DOOR OPEN
OUTPUTS	MONITORS THE STATE OF DC OUTPUTS (evap & condenser fans 0 - 100% and lighting off - low - med - high)	RETURN TO MENU OUTPUTS L EVAP FAN = 0% R EVAP FAN = 0%
OFFSETS	OFFSETS ARE USED TO ADJUST OR CORRECT THERMISTOR READINGS CORRECTED VALUES MAY BE VIEWED THROUGH THE CUSTOMER MENU	RETURN TO MENU OFFSETS RIGHT ZONE = -18°C RIGHT EVAP = -17°C
SELF TEST	SELF TEST IS USED TO DIAGNOSE THE BOARD IF NO ERRORS ARE PRESENT "NO ERRORS" WILL BE DISPLAYED, THE MAIN BOARD IS FUNCTIONING PROPERLY	RETURN TO MENU SELF TEST NO ERRORS
DIFFERENTIALS	DIFFERENTIALS ARE USED TO DETERMINE AT WHAT TEMPERATURE THE UNIT CYCLES. "0" SETTING IS +/- 2° DIFFERENTIAL	RETURN TO MENU DIFFERENTIALS LEFT = -16°C RIGHT = -16°C
EVAP FAN	THIS MENU IS USED TO SET THE DURATION THE EVAPORATOR FAN WILL RUN AFTER THE COMPRESSOR CYCLES OFF	RETURN TO MENU EVAP FAN EVAP FAN ON = 1 EVAP FAN OFF = 60
MULLION	THIS MENU IS USED TO SET THE DURATION THE MULLION HEATER WILL BE ON AFTER THE COMPRESSOR CYCLES OFF	RETURN TO MENU MULL MULL ON=5 MULL OFF=30
FACTORY DEFAULT	FACTORY DEFAULT IS USED TO RESTORE ALL SETTINGS TO THE FACTORY DEFAULT FOR THE SELECTED MODEL	RETURN TO MENU FACTORY DEFAULT RESTORE?
RE-SELECT MODEL #	RE-SELECT MODEL IS USED TO MODIFY THE MODEL INFORMATION CHANGING THE MODEL COMPLETELY REPROGRAMS AVAILABLE ZONES	RETURN TO MENU RE-SELECT MODEL 3090WCWC
FACTORY Wi Fi	THIS SETTING IS FOR FACTORY USE ONLY AND SHOULD REMAIN OFF	RETURN TO MENU FACTORY WIFI OFF
FAN DELAY	FAN DELAY ALLOWS MODIFICATION OF FAN RUN TIMES BOTH AT THE START OF A COOLING CYCLE AND AT THE END AFTER THE COMPRESSOR STOPS	RETURN TO MENU FAN DELAY FAN 1 DELAY OFF = 1 FAN 2 DELAY ON = 2
SHOWROOM MODE	RANDOMLY SCROLLS THROUGH ZONES, MODES, TEMPERATURES AND OTHER FEATURES. TOUCH AND HOLD  TO EXIT SHOWROOM MODE	RETURN TO MENU SHOWROOM MODE OFF
EXIT	SCROLL DOWN TO "EXIT". TOUCH AND RELEASE  TO EXIT SERVICE MODE	FAN DELAY USB PORT SHOWROOM MODE EXIT

SERVICE MENU





In addition to a feature rich customer menu, the 3000 series also offers a service menu with the ability to fine tune and monitor unit operation.

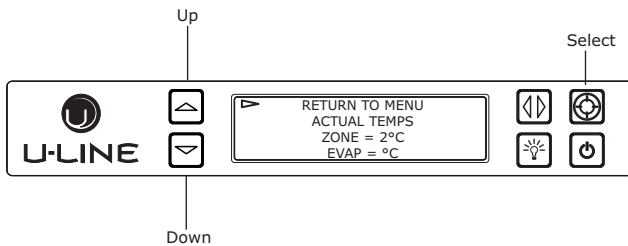

To initiate the Service menu hold both  and  for 5 seconds.

Actual Temps



The Actual Temp option in the service menu will display raw thermistor readings without calculating offsets.

1. Press  to select "Actual Temps".
2. Press .
3. Use  and  to scroll through available thermistor readings.

To exit the Actual Temps menu press  to select "Return to Menu" and press  to confirm.



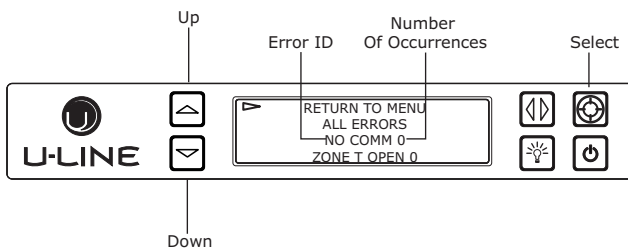

All Errors







The All Errors option keeps record of any system errors. When an error occurs it is recorded to all errors. The number next to the error indicates the number of recorded instances. Errors in the log may not be currently active. The error log memory is non volatile and is persistent should power be lost and restored to the unit. See below for a list of logged errors and their respective descriptions.



ID	Description	Solution
No Comm	Unit lost communication to the display.	Unplug the communication cable from the user interface. Check the black to red conductors looking for 5 VDC. If voltage is present replace the user interface. If no voltage is present check for 5 VDC at the main board where the communication cable plugs onto the pins for the red and black conductors. If 5 VDC is not present replace the main control board. If 5 VDC is present replace the communication cable.
Bin T Open	Bin thermistor circuit open.	Check thermistor connection to harness for moisture or corrosion. Also check connection where thermistor harness attaches to main board. If connections are valid replace the thermistor.
Condenser T Open	Evaporator thermistor circuit open.	
Bin T Short	Bin thermistor circuit shorted.	
Condenser T Short	Condenser thermistor circuit shorted.	
Temp Hi 6H+	Not used.	Not used.
Temp Lo 6H+	Not used.	Not used.
Temp Hi 12H+	Not used.	Not used.
Temp Lo 12H+	Not used.	Not used.
Time to Clean	Water circulation system requires cleaning.	Clean unit with 37050 cleaner.
Door Open 5M	Door switch open for more than 5 minutes.	Check door switch magnet reed switch alignment when door is in closed position. Check reed switch connection at the harness and the main board.
Drain Blocked	Drain pump has detected a problem.	Check drain hose for restriction or drain pump for correct operation.
WTD Reset	Software reset if communication is lost	No Action Required



To access All Errors follow the steps below.

1. Press  to select "All Errors".
2. Press .
3. Press  and  to scroll through available information.

1. Use  to select "Relay Status".
2. Press .
3. Press  and  to scroll through available information.

To exit the Relay Status simply press  to exit.

To clear the error log press  to select "Clear Errors" and press  to confirm.

To exit the Actual Temps menu press  to select "Return to Menu" and press  to confirm.

Relay Status

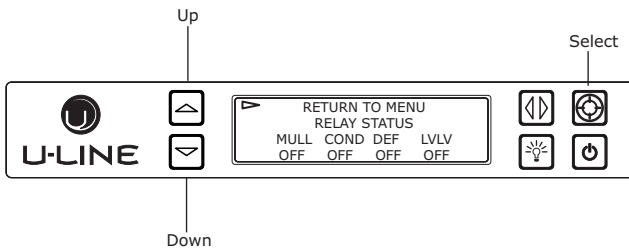

Relay status displays the current state of each relay. While all available relays are displayed, only a portion are used.

ID	Description	Availability
Mull	Mullion Heater	Not Used
Pump	Circulation Pump	Used
Wate	Water Valve	Used
Harv	Harvest	Used
Cond	Condenser Fan	Used
Comp	Compressor	Used

NOTE: The Cond (Condenser Fan) will switch state with the compressor relay, however the condenser fan is actually powered through a DC output. Condenser fan status can be viewed through the "Output" service menu option.

To access Relay Status

Relay Toggle

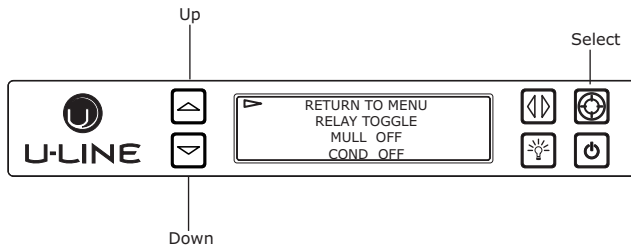

Relay toggle is used to manually switch the state of each relay to test for proper operation. In addition to the AC relays, DC switches may also be toggled. Relay toggle can also be used to force the unit into a particular state.

ID	Description	Voltage
Mull	Not Used	AC
Pump	Circulation Pump	AC
Water	Water Valve	AC
Harvest	Harvest	AC
Cond	Condenser Fan	AC
Comp	Compressor	AC
Fan 1	Not Used	N/A
Fan 2	Not Used	N/A
Fan 3	Not Used	N/A
Light 1	Zone Lighting	DC
N/A	N/A	N/A

To access Relay Toggle

- Press to select "Relay Toggle".
- Press .
- Press and to scroll through each relay and DC output.
- Press to toggle.

To exit the Relay Toggle menu press to select "Return to Menu" and press to confirm.

Input Status

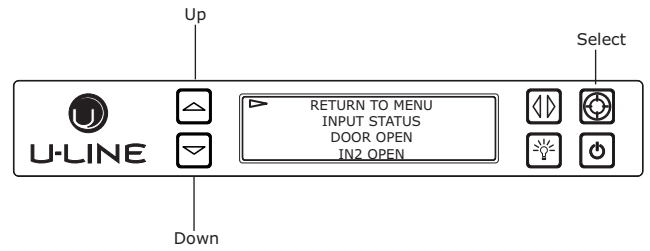

Input status displays the current state of each available input.

ID	Description	State
Pump	Circulation Pump	Open - Closed

To access Input Status

- Press to select "Input Status".
- Press .
- Press and to scroll through available information.

To exit the Input Status menu press to select "Return to Menu" and press to confirm outputs.



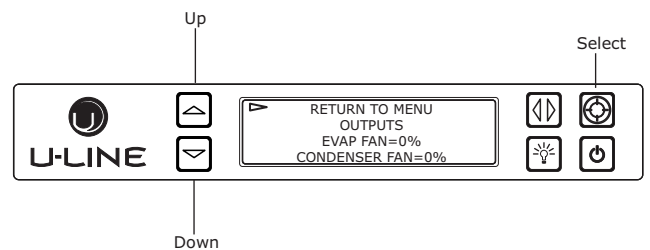

Outputs





Outputs is used to monitor the state of DC outputs.

ID	Description	Value
Light	Zone Lighting	Off - Low - Med - High

To access Outputs

1. Press  to select "Outputs".
2. Press .
3. Press  and  to scroll through available information.

To exit the Input Status menu, press  to select "Return to Menu" and press  to confirm.

Offsets

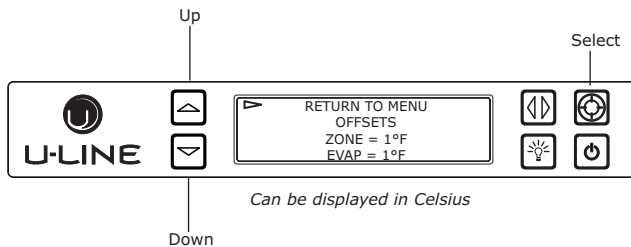





NOTICE





Do not make an adjustment to this without first contacting the tech line: (800) 779-2955.



Offsets are used to adjust or correct thermistor readings. Offset values are added to the current thermistor reading and are then used by the control board to determine cooling and defrost cycle times. Offsets have a range of +/- 10°F. Corrected values may be viewed through the customer "All Temps" menu.

To access Offsets

1. Press  to select "Offsets".
2. Press .
3. Press  and  to scroll through available thermistors.

To change offsets

4. Press , the selected thermistor will begin to flash.
5. Press  or  to modify offset value.
6. Press  to confirm setting.



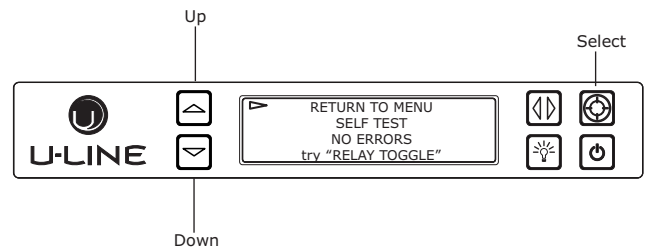

To exit the Offset menu, press  to select "Return to Menu" and press  to confirm.



Self Test



Self test is used to initiate a self diagnostic report. Any system faults will be displayed under Self test. If no errors are present "no errors" will be displayed and the main control board is functioning properly. The main control board is extremely robust and should rarely require service. Most issues are external to the control. Reference troubleshooting for more information.

To access Self Test

1. Press  to select "Self Test".
2. Press .
3. Press  and  to scroll through available information.

To exit the Self Test, Press  to select "Return to Menu" and press .

Differentials

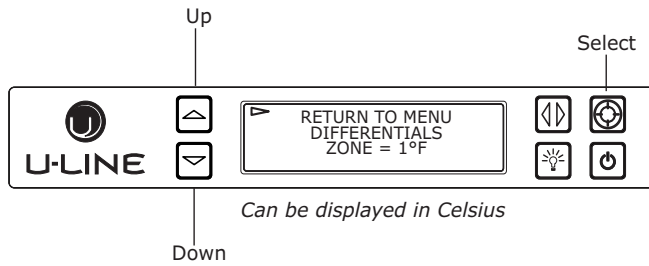

(DO NOT MAKE AN ADJUSTMENT TO THIS WITHOUT CONTACTING TECH LINE: 800-779-2955)

Differentials are used to determine the maximum variation from set point and have a range of 0 through 10. The table below shows the effect of differentials on cooling cycles with a set point of 45°F (7°C).

NOTE: Air temperature does not reflect product temperatures.

Differential	Cycle Start °F (°C)	Cycle End °F (°C)
0	45° (7°)	43° (6°)
1	46° (8°)	43° (6°)
2	47° (8°)	41° (5°)
3	48° (9°)	41° (5°)
4	49° (10°)	39° (4°)
5	50° (10°)	37° (3°)

The graph below shows a unit's cooling cycle over time with various differentials.

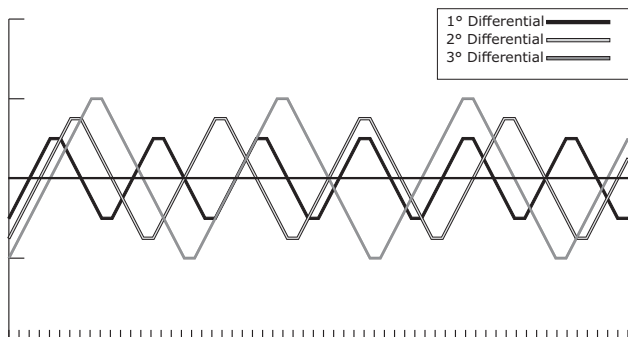

Evap Fan (Not Used)

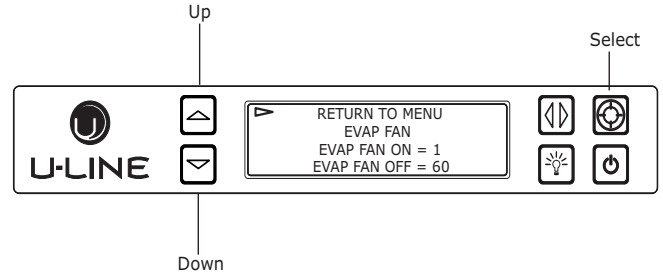

The Evap Fan option in the service menu allows servicers to change the Evaporator Fan runtime (in minutes) from 0 to 98 and OFF cycle time 0 to 98.

To access Evap Fan

1. Press to select "Evap Fan".
2. Press .
3. Press and to scroll through available settings.

To exit the Evap Fan menu, press to select "Return to Menu" and press to confirm.

Mullion (Not Used)

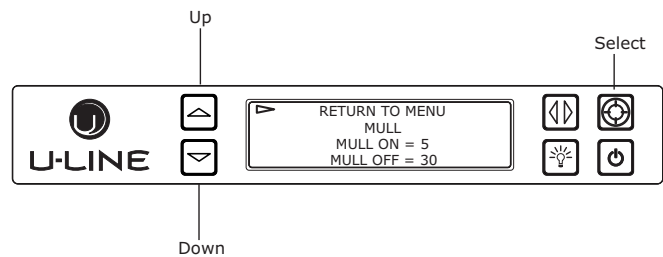

The Mullion (MULL) option in the service menu allows servicers to change the ON/OFF time in minutes of the MULL heater (DWR only) from 0 to 98.

To access Mullion

1. Press to select "MULL".
2. Press .
3. Press and to scroll through available settings.

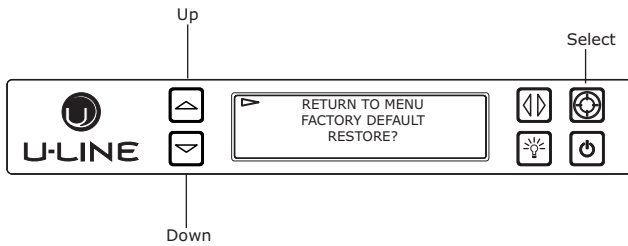

To exit the MULL menu, press to select "Return to Menu" and press to confirm.

Factory Default







Factory Default will restore all settings to their factory default.

To access Factory Default

1. Press  to select "Factory Default".
2. Press .

To restore settings to their factory default.

3. Press  to select "Restore?" and press .
4. "Restore?" will change to "Restoring..." while settings are restored. When restoration is complete, "Restoring..." will return to "Restore?".

To exit Factory Default, press  to select "Return to Menu" and press  to confirm.

Re-Select Model

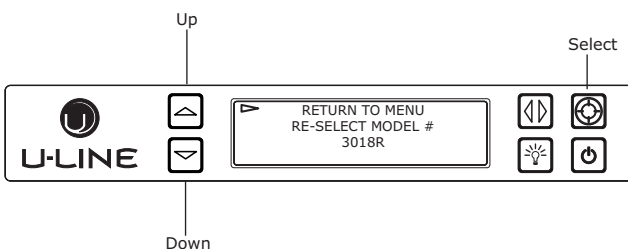



NOTICE







Before altering model selection U-Line customer service must be notified. Failure to notify customer service will result in voiding of the manufacturer warranty.



Re-Select Model allows the units model information to be modified. Changing the units model completely reprograms available zones, relay assignments, DC output assignments etc.

To access Re-Select Model

1. Press  to select "Re-Select Model".
2. Press .

To change model setting





3. Press  to select "Model=" and press . "Model" will begin to flash.
4. Press  or  to scroll through each available model.
5. Press  to confirm. While processing, the  will momentarily change to .

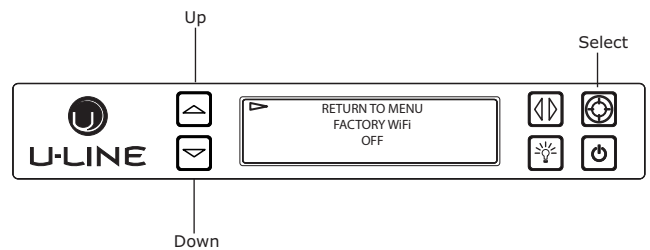

To exit Re-Select Model, press  to select "Return to Menu" and press  to confirm. (Power cycling unit is recommended after re-selecting model.)

Factory Wi Fi



The Factory Wi-Fi option is only used in manufacturing and should always be OFF.

1. Press  to select "Factory Wi Fi".
2. Press .
3. Press  or  select "OFF".

To exit the Factory Wi Fi menu press  to select "Return to Menu" and press  to confirm outputs.

Fan Delay

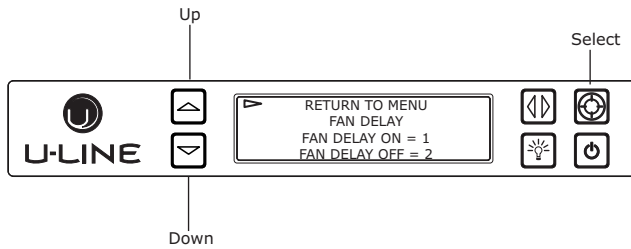

The Fan Delay menu option allows the modification of fan run times during and after a cooling cycle. In order to allow time for the evaporator to properly cool, the evaporator fan is delayed from starting with the cooling cycle for a given amount of time. In order to remove as much warmth as possible from the cabinet the evaporator fan will continue to run at the end of the cooling cycle for a given amount of time.

Fan Delay On=

“Fan Delay On” is the amount of time in minutes the fan will be delayed from starting from the beginning of a cooling cycle.

Fan Delay Off=

“Fan Delay Off” is the amount of time in minutes the fan will continue to run at the end of a cooling cycle.

To access Fan Delay

1. Press to select “Fan Delay”.
2. Press .

To change fan delay

3. Press to select either “Fan Delay On” or “Fan Delay Off” and press . The chosen option will begin to flash.
4. Press or to change settings.
5. Press to confirm.

To exit Fan Delay, press to select “Return to Menu” and press to confirm.

Showroom Mode

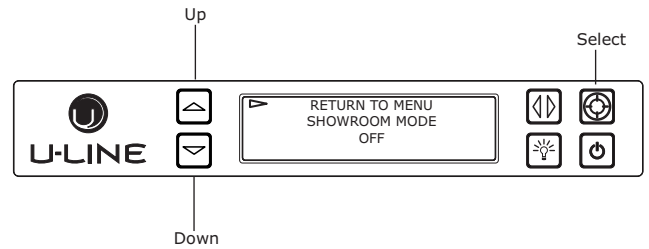

Showroom displays a number of features and allows the unit to be powered on without running the cooling system.

To toggle showroom mode

1. Press to select “Showroom Mode”.
2. Press .
3. Press to select “Off” and press . “Off” will begin to flash.
4. Press or to toggle between off and on.
5. Press to confirm.

If set to “on” showroom mode will begin immediately. To exit showroom mode press and hold for 5 seconds and release. The display will show a countdown to switching the unit off. Press again and the unit will immediately switch on retaining the presets from before it entered showroom mode.

To exit the showroom mode menu, press to select “Return to Menu” and press to confirm.

Thermistors

Thermistors are used for various temperature readings. Thermistors provide reliable temperature readings using a resistance which varies based on surrounding temperatures. If a faulty thermistor is suspected it may be tested using an accurate ohmmeter.

Thermistor connections must be kept clean. A thermistor connection that has become corroded can cause resistance values from the thermistor to change as they pass through a dirty connection to the board.

It is for that reason that we apply dielectric grease to all of our thermistor connections. Dielectric grease will help to keep thermistor connections clean and dry.

If you change a thermistor in the unit please re-apply dielectric grease to the connection. If you encounter a dirty thermistor connection, you should replace the thermistor and the thermistor harness.

This unit has **three** thermistors.

Thermistor one (Ice Bin):

Located along the right hand side wall of the ice bin. It is used to maintain the ice level in the bin.

Thermistor two (Condenser Line Out):

Located on the liquid line. It is used during freeze/harvest.

Thermistor three (Ambient):

Located in the base of the unit (secured to the condenser). It is used to monitor the ambient temperature within the base compartment. It is used for diagnostics.

This unit uses two different thermistors: *Ice Bin and Ambient Thermistors; Condenser Line Out Thermistor.*

The Ice Bin and Ambient Thermistors are both type 1 thermistors. If a thermistor is suspected of being defective the resistance can be verified. Place the thermistor in an ice water bath, the resistance should read 16.5k OHMs +/-5% on your meter.

Thermistor Resistance Data - Type 1

Temp (F)	Temp (C)	Nominal Resistance (OHMS)*
-40	-40	169157
-31	-35	121795
-22	-30	88766
-13	-25	65333
-4	-20	48614
5	-15	36503
14	-10	27681
23	-5	21166
32	0	16330
41	5	12696
50	10	9951
59	15	7855
68	20	6246
77	25	5000
86	30	4029
95	35	3266
104	40	2665
113	45	2186
122	50	1803
131	55	1495
140	60	1247
149	65	1044
158	70	879
167	75	743
176	80	631

* (+/-5%)

The Condensor Line Out Thermistor is a type 2 thermistor. At 77° the resistance should read 10k OHMS +/-5%.

Thermistor Resistance Data - Type 2

Temp (F)	Temp (C)	Nominal Resistance (OHMS)*
-22	-30	177000
-13	-25	130370
-4	-20	97070
5	-15	72929
14	-10	55330
23	-5	42315
32	0	32650
41	5	25388
50	10	19900
59	15	15708
68	20	12490
77	25	10000
86	30	8057
95	35	6531
104	40	5327
113	45	4369
122	50	3603
131	55	2986
140	60	2488
149	65	2083
158	70	1752
167	75	1481
176	80	1258
185	85	1072
194	90	9177
203	95	7885
212	100	6800

* (+/-5%)

Defrost

These models have no defrost options.

U-Line Corporation (U-Line) Limited Warranty

One Year Limited Warranty

For one year from the date of original purchase, this U-Line product warranty covers all parts and labor to repair or replace any part of the product that proves to be defective in materials or workmanship. For products installed and used for normal residential use, material cosmetic defects are included in this warranty, with coverage limited to 60 days from the date of original purchase. All service provided by U-Line under the above warranty must be performed by U-Line factory authorized service, unless otherwise specified by U-Line. Service provided during normal business hours.

Available Second Year Limited Warranty

Beyond the standard one year warranty outlined above, U-Line offers an extension of the one year warranty coverage for an additional second year from the date of purchase, free of charge. To take advantage of this second year warranty, you must register your product with U-Line within two months from the date of purchase at u-line.com providing proof of purchase.

Five Year Sealed System Limited Warranty

For five years from the date of original purchase, U-Line will repair or replace the following parts, labor not included, that prove to be defective in materials or workmanship: compressor, condenser, evaporator, drier, and all connecting tubing. All service provided by U-Line under the above warranty must be performed by U-Line factory authorized service, unless otherwise specified by U-Line. Service provided during normal business hours.

Terms

These warranties apply only to products installed in any one of the fifty states of the United States, the District of Columbia, or the ten provinces of Canada. The warranties do not cover any parts or labor to correct any defect caused by negligence, accident or improper use, maintenance, installation, service, repair, acts of God, fire, flood or other natural disasters. The product must be installed, operated, and maintained in accordance with the U-Line User Guide.

The remedies described above for each warranty are the only ones that U-Line will provide, either under these warranties or under any warranty arising by operation of law. U-Line will not be responsible for any consequential or incidental damages arising from the breach of these warranties or any other warranty, whether express, implied, or statutory. Some states do not allow the exclusion or limitation of incidental or consequential damages, so the above limitation or exclusion may not apply to you. These warranties give you specific legal rights, and you may also have other rights which vary from state to state.

Any warranty that may be implied in connection with your purchase or use of the product, including any warranty of *merchantability* or any warranty *fit for a particular purpose* is limited to the duration of these warranties, and only extends to five years in duration for the parts described in the section related to the five year limited warranty above. Some states do not allow limitations on how long an implied warranty lasts, so the above limitations may not apply to you.

- The warranties only apply to the original purchaser and are non-transferable.
- The second year and five year warranties cover products installed and used for normal residential or designated marine use only.
- The warranties apply to units operated outside only if designed for outdoor use by model and serial number.
- Replacement water filters, light bulbs, and other consumable parts are not covered by these warranties.
- The start of U-Line's obligation is limited to four years after the shipment date from U-Line.
- In-home instruction on how to use your product is not covered by these warranties.
- Food, beverage, and medicine loss are not covered by these warranties.
- If the product is located in an area where U-Line factory authorized service is not available, you may be responsible for a trip charge or you may be required to bring the product to a U-Line factory authorized service location at your own cost and expense.
- Units purchased after use as floor displays, and/or certified reconditioned units, are covered by the limited one year warranty only and no coverage is provided for cosmetic defects.
- Signal issues related to Wi-Fi connectivity are not covered by these warranties.

For parts and service assistance, or to find U-Line factory authorized service near you, contact U-Line:
 8900 N. 55th Street, Milwaukee, WI 53223 • u-line.com • onlineservice@u-line.com • +1.800.779.2547