



OWNER'S MANUAL

WASHING MACHINE

Please read this owner's manual thoroughly before operating and keep it handy for reference at all times. Operating Instructions are available on the LG website at: https://us.smarthinq.com/images/pdfmanual/VH_FL_VICTOR_899_MFL68005566_EN.pdf

WM3700H*A



MFL68005566
Rev.00_042318

www.lg.com

Copyright © 2018 LG Electronics Inc. All Rights Reserved.

TABLE OF CONTENTS

3 SAFETY INSTRUCTIONS

- 3 IMPORTANT SAFETY INSTRUCTIONS

7 PRODUCT OVERVIEW

- 7 Parts
- 7 Accessories

8 INSTALLATION

- 8 Tools Needed
- 8 Installation Overview
- 9 Product Specifications
- 10 Choosing the Proper Location
- 11 Unpacking and Removing Shipping Bolts
- 12 Connecting the Water Lines
- 13 Connecting the Drain Hose
- 14 Leveling the Washer
- 15 Connecting to the Power Supply
- 15 Testing the Washer

16 OPERATION

- 16 Using the Washer
- 17 Loading the Washer

18 SMART FUNCTIONS

- 18 LG SmartThinQ Application
- 21 Smart Diagnosis™ Function

22 MAINTENANCE

- 22 Regular Cleaning
- 24 Cleaning the Door Seal
- 24 Cleaning the Water Inlet Filters
- 25 Cleaning the Drain Pump Filter
- 26 Care in Cold Climates

27 TROUBLESHOOTING

- 27 FAQs: Frequently Asked Questions
- 28 Before Calling for Service

36 LIMITED WARRANTY

- 36 FOR USA
- 39 FOR CANADA
- 43 Warranty Exceptions (U.S. and Canada)

This manual contains an abbreviated Operation section. For the complete Operation section, scan the QR code below or visit: https://us.smarthing.com/images/pdfmanual/VH_FL_VICTOR_899_MFL68005566_EN.pdf



SAFETY INSTRUCTIONS

READ ALL INSTRUCTIONS BEFORE USE

Your safety and the safety of others are very important.

We have provided many important safety messages in this manual and on your appliance. Always read and follow all safety messages.

This is the safety alert symbol.



This symbol alerts you to potential hazards that can kill or injure you and others.

All safety messages will follow the safety alert symbol and either the word WARNING or CAUTION.

These words mean:



WARNING

If you do not follow instructions, it could result in death or serious injury.



CAUTION

If you do not follow instructions, it could result in minor or moderate injury or damage to the product.

All safety messages tell you what the potential hazard is, tell you how to reduce the chance of injury, and tell you what may happen if the instructions are not followed.

IMPORTANT SAFETY INSTRUCTIONS



WARNING

To reduce the risk of explosion, fire, death, electric shock, scalding or injury to persons when using this product, follow basic precautions, including the following:

California Safe Drinking Water and Toxic Enforcement Act

- This product contains chemicals known to the State of California to cause cancer and birth defects or other reproductive harm. **Wash hands after handling.** (USA only)

INSTALLATION

- Adhere to all industry recommended safety procedures including the use of long-sleeved gloves and safety glasses.
- Never attempt to operate this appliance if it is damaged, malfunctioning, partially disassembled, or has missing or broken parts, including a damaged cord or plug.
- Before use, the appliance must be properly installed as described in this manual.
- To reduce the risk of severe injury or death, follow all installation instructions.
- Refer to the INSTALLATION INSTRUCTIONS for detailed grounding procedures. Installation instructions are packed with the appliance for the installer's reference. If the appliance is moved to a new location, have it checked and reinstalled by qualified service personnel.
- Moving or installation of the appliance requires two or more people.
- Do not install the appliance in humid spaces.
- Store and install the appliance where it will not be exposed to temperatures below freezing or exposed to outdoor weather conditions.
- This appliance is not designed for maritime use or for mobile installations such as in RVs, trailers, or aircraft.

- Keep packing materials out of the reach of children. Packaging material can be dangerous for children. There is a risk of suffocation.
- Destroy the carton, plastic bag, and other packing materials after the appliance is unpacked. Children might use them for play. Cartons covered with rugs, bedspreads, or plastic sheets can become airtight chambers.
- The appliance must be installed and electrically grounded by qualified service personnel in accordance with local codes.
- Do not, under any circumstances, cut or remove the third (ground) prong from the power cord.
- When installing or moving the appliance, be careful not to pinch, crush, or damage the power cord.
- Connect to a properly rated, protected, and sized power circuit to avoid electrical overload.
- This appliance must be positioned near to an electrical power supply.
- Disconnect the power cord, house fuse or circuit breaker before installing or servicing the appliance.
- The power cord of this appliance is equipped with a 3-prong (grounding) plug which mates with a standard 3-prong (grounding) wall outlet to minimize the possibility of electric shock from this appliance.
- Use new hoses when connecting the appliance to the water supply. Do not reuse old hoses.

OPERATION

- Read all instructions before using the appliance and save these instructions.
- Use this appliance only for its intended purpose.
- If the product has been submerged, contact an LG Electronics customer information center for instructions before resuming use.
- If you detect a strange sound, a chemical or burning smell, or smoke coming from the appliance, unplug it immediately, and contact an LG Electronics customer information center.
- Under certain conditions, hydrogen gas may be produced in a hot-water system that has not been used for two weeks or more. **HYDROGEN GAS IS EXPLOSIVE.** If the hot-water system has not been used for such a period, before using the appliance turn on all hot water faucets and let the water flow from each for several minutes. This will release any accumulated hydrogen gas. As the gas is flammable, do not smoke or use an open flame during this time.
- Do not reach into the washer if the tub or drum, agitator, or any interior parts are moving. Before loading, unloading, or adding items, press Start/Pause and allow the tub or drum to coast to a complete stop before reaching inside.
- This appliance is not intended for use by persons (including children) with reduced physical, sensory or mental capabilities, or lack of experience and knowledge, unless they have been given supervision or instruction concerning the use of the appliance by a person responsible for their safety.
- Do not allow children or pets to play on, in or with the appliance. Close supervision is necessary when the appliance is used near children or pets.
- Keep laundry products out of children's reach. To prevent injury to persons, observe all warnings on product labels.
- Repair or immediately replace all power cords that have become frayed or otherwise damaged. Do not use a cord that shows cracks or abrasion damage along its length or at either end.
- Never unplug the appliance by pulling on the power cord. Always grip the plug firmly and pull straight out from the outlet.
- Do not use an extension cord or adapter with this appliance.
- Do not grasp the power cord or touch the appliance controls with wet hands.
- Do not modify or extend the power cord.

- If the electrical supply cord is damaged, it must only be replaced by the manufacturer or its service agent or a similar qualified person in order to avoid a hazard.
- Do not put oily or greasy clothing, candles or flammable materials on top of the appliance.
- Keep the area underneath and around your appliances free of combustible materials (lint, paper, rags, etc.), gasoline, chemicals and other flammable vapors and liquids.
- Do not store or use gasoline or other flammable vapors and liquids in the vicinity of this or any other appliance.
- Do not mix chlorine bleach with ammonia or acids such as vinegar. Follow package directions when using laundry products. Incorrect usage can produce poisonous gas, resulting in serious injury or death.
- Never use harsh chemicals, abrasive cleaners, or solvents to clean the washer. They will damage the finish.
- Do not wash articles that have been previously cleaned in, washed in, soaked in, or spotted with gasoline, dry-cleaning solvents, vegetable or cooking oil, or other flammable or explosive substances, as they give off vapors that could ignite or explode.
- Do not add gasoline, dry cleaning solvents, or other flammable or explosive substances to the wash water. These substances give off vapors that could ignite or explode.
- In the event of a gas leak (propane gas, LP gas, etc.) do not operate this or any other appliance. Open a window or door to ventilate the area immediately.
- Do not tamper with controls.
- Fix the drain hose securely in place to avoid flooding.
- Do not abuse, sit on, or stand on the door of the appliance.

MAINTENANCE

- Do not repair or replace any part of the appliance. All repairs and servicing must be performed by qualified service personnel unless specifically recommended in this owner's manual. Use only authorized factory parts.
- Disconnect this appliance from the power supply before cleaning and attempting any user maintenance. Turning the controls to the OFF position does not disconnect this appliance from the power supply.
- Remove any dust or foreign matter from the power plug pins.
- Do not disassemble or repair the appliance by yourself.
- Remove the door before the appliance is removed from service or discarded to avoid the danger of children or small animals getting trapped inside.
- Make sure the dispenser drawer or lid is closed at all times when not being filled with laundry products.

GROUNDING INSTRUCTIONS

- Improper connection of the equipment-grounding conductor can result in a risk of electric shock. Check with a qualified electrician or service personnel if you are in doubt whether the appliance is properly grounded. Do not modify the plug provided with the appliance; if it will not fit the outlet, have a proper outlet installed by a qualified electrician.
- The appliance must be grounded. In the event of a malfunction or breakdown, grounding will reduce the risk of electric shock by providing a path of least resistance for electric current. The appliance is equipped with a cord having an equipment-grounding conductor and a grounding plug. The plug must be plugged into an appropriate outlet that is installed and grounded in accordance with all local codes and ordinances.

 CAUTION

To reduce the risk of minor or moderate injury to persons, malfunction, or damage to the product or property when using this product, follow basic precautions, including the following:

INSTALLATION

- Install the product on a firm and level floor.

OPERATION

- Do not place objects on top of the appliance.
- Turn off the water faucets and unplug the appliance if the appliance is to be left for an extended period of time, such as during vacations.
- ALWAYS follow the fabric care instructions supplied by the garment manufacturer.
- Use fabric softeners or products to eliminate static only as recommended by the manufacturer.
- Do not combine laundry products for use in one load unless specified on the label.
- Do not touch draining water which may be hot.
- If the drain hose and the water supply hose are frozen in winter, defrost them before using the appliance.
- Do not store or spill liquid detergents, cleaners, or bleaches (chlorine bleach, oxygen bleach) on the appliance. Doing so may result in corrosion, discoloration or damage to the surface of the appliance.
- Clothing or articles that are waterproof or water resistant must be washed in the Waterproof cycle only. (e.g. water resistant clothing, mattress covers, outdoor clothes, plastic mats, etc.) Otherwise, it may result in personal injury or damage to the washer, clothes, walls, floor, and surrounding objects due to abnormal vibration.

SAVE THESE INSTRUCTIONS

PRODUCT OVERVIEW

Parts

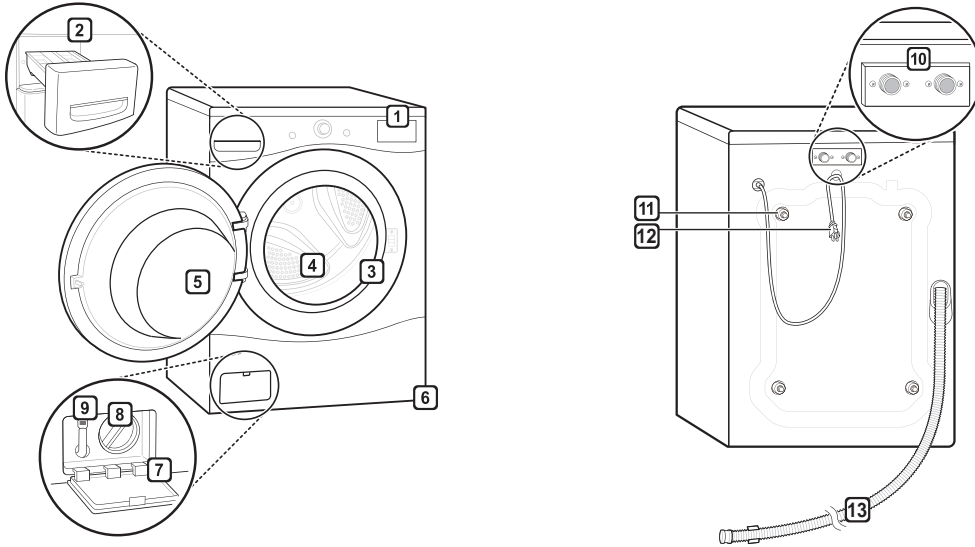

- | | | | |
|-------------------------------------|------------------------|----------------------------------|--------------------------|
| 1 Control Panel | 4 Drum | 7 Drain Pump Filter Cover | 10 Water Inlets |
| 2 Detergent Dispenser Drawer | 5 Door | 8 Drain Pump Filter | 11 Shipping Bolts |
| 3 Door Seal | 6 Leveling Feet | 9 Drain Hose | 12 Power Cord |
| | | | 13 Drain Hose |

Accessories

Included Accessories



Non-skid pads



Hole caps (4)



Wrench



Tie strap

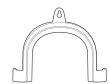

Elbow bracket
(for securing drain hose)

Required Accessories

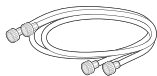

Hot/cold water hoses
(sold separately)

Optional Accessories

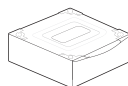

Pedestal or Pedestal washer
(sold separately)



Stacking Kit
(sold separately)

NOTE

- The images in this guide may be different from the actual components and accessories, which are subject to change by the manufacturer without prior notice for product improvement purposes.
- For your safety and for extended product life, use only authorized components. The manufacturer is not responsible for product malfunction or accidents caused by the use of separately purchased unauthorized components or parts.

INSTALLATION

Tools Needed



Pliers

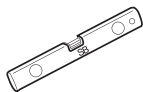

Level

Installation Overview

Please read the following installation instructions first after purchasing this product or transporting it to another location.

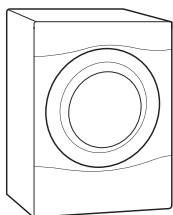

Choosing the proper location

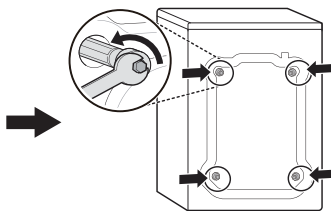

Unpacking and removing shipping bolts

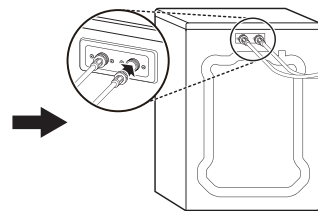

Connecting the water lines

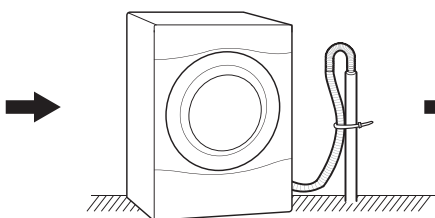

Connecting the drain line

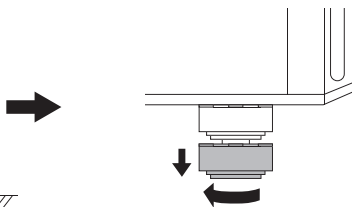

Leveling the washer

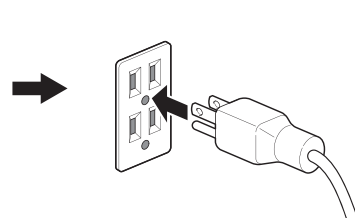

Connecting to the power supply

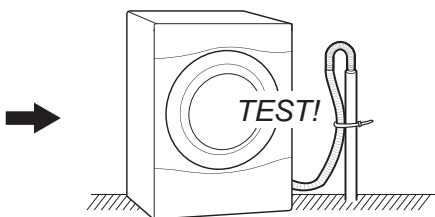

Testing the washer

Product Specifications

The appearance and specifications listed in this manual may vary due to constant product improvements.

Electrical requirements	120 VAC @ 60 Hz
Min. / Max. water pressure	20 – 120 psi (138–827 kPa)
Dimensions	70 cm(W) X 77 cm(D) X 99 cm(H), 139.6 cm (D with door open) 27"(W) X 30 ¼"(D) X 39"(H), 55" (D with door open)
Net weight	187.4 lb (85 kg)
Max spin speed	1300 RPM

WARNING

- Moving or installation of the appliance requires two or more people. Failure to follow these instructions may result in injury.
- Store and install the appliance where it will not be exposed to temperatures below freezing or exposed to outdoor weather conditions. Failure to follow this warning can cause product or part failure, serious injury, fire, electric shock, or death.
- Properly ground the washer to conform with all governing codes and ordinances. Failure to follow this warning can cause serious injury, fire, electric shock, or death.
- To reduce the risk of electric shock, do not install the appliance in humid spaces. Failure to follow this warning can cause serious injury, fire, electric shock, or death.
- To ensure proper airflow, do not block the large opening on the bottom of the washer with carpeting or other materials.
- Do not remove the ground prong. Do not use an adapter or extension cord. Plug into a grounded 3-prong outlet. Failure to follow this warning can cause serious injury, fire, electric shock, or death.
- Certain internal parts are intentionally not grounded and may present a risk of electric shock only during servicing. Service personnel - Do not contact the following parts while the appliance is energized: pump, valve, motor, control board.

Choosing the Proper Location

Install the washer on a solid floor that is strong and rigid enough to support the weight of the washer, even when fully loaded, without flexing or bouncing. If the floor has too much flex, you may need to reinforce it to make it more rigid. If the floor is not solid, it may cause severe vibration and noise.

NOTE

- Before installing the washer, make sure the floor is clean, dry and free of dust, dirt, water and oil so the washer feet cannot slide easily. Leveling feet that can move or slide on the floor can contribute to excess vibration and noise due to poor contact with the floor.
- If a drip pan must be used, take extra care to follow the instructions provided with the drip pan and make sure the leveling feet are adjusted for firm and even contact with the pan. Use of drip pans and failure to properly level the machine may result in increased vibration and noise during operation.
- Allow for sufficient space between the walls and the washer for installation.

Power Outlet

- The power outlet must be within 60 inches (1.5 m) of either side of the washer.
- The appliance and outlet must be positioned so that the plug is easily accessible.
- Do not overload the outlet with more than one appliance.
- The outlet must be grounded in accordance with current electrical wiring codes and regulations.
- Use a time-delay fuse or circuit breaker.

NOTE

- It is the personal responsibility and obligation of the product owner to have a proper outlet installed by qualified service personnel.

Flooring

- To minimize noise and vibration, the washer must be installed on a solidly constructed floor.
- Allowable slope under the entire washer is a maximum 1 inch (2.5 cm) difference from side to side or from front to back.
- Installing on carpeting and soft tile surfaces is not recommended.
- Never install the washer on a platform or weakly supported structure.

NOTE

- The washer must be installed on firm flooring to minimize vibration during the spin cycle. Concrete flooring is best, but a wood floor is sufficient, provided it is built to FHA standards.

Floor Installation

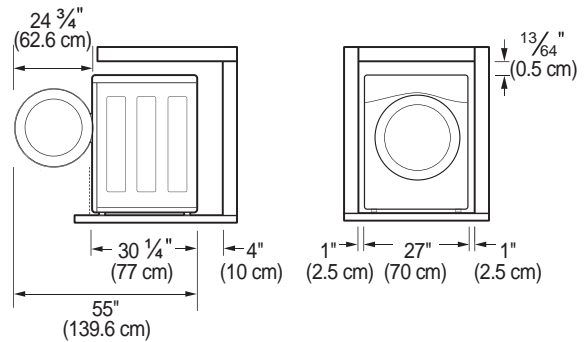

To ensure sufficient clearance for water lines, the drain line and airflow, allow minimum clearances of at least 1 inch (2.5 cm) at the sides and 4 inches (10 cm) behind the unit. Be sure to allow for wall, door, or floor moldings that may increase the required clearances.

Stacked or Pedestal Installation

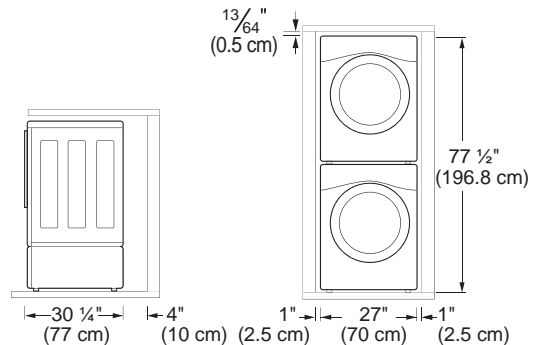

NOTE

- Refer to the instructions packaged with the optional pedestal kit before installing with a pedestal kit.
- Do not use a drip pan with a pedestal or pedestal washer installation as it can block the drawer. Using a drip pan may result in increased vibration and noise during operation.

Unpacking and Removing Shipping Bolts

Unpack all shipping materials from the washer for proper operation and inspect it for shipping damage.

CAUTION

- Failure to remove shipping materials can cause excessive noise and vibration.

1 Lift the washer off the foam base.

After removing the carton and shipping material, lift the washer off the foam base. Make sure the plastic tub support comes off with the base and is not stuck to the bottom of the washer.

If you must lay the washer down to remove the base packaging materials, always protect the side of the washer and lay it carefully on its side. Do not lay the washer on its front or back.

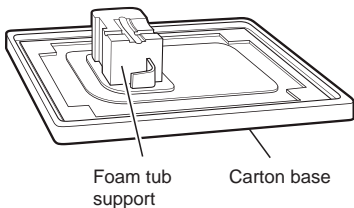

2 Remove the bolt assemblies.

Starting with the bottom two shipping bolts, use the wrench (included) to fully loosen all four shipping bolts by turning them counterclockwise. Remove the bolt assemblies by wiggling them slightly while pulling them out.

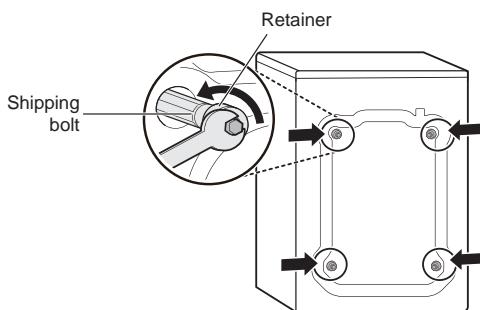

3 Install the hole caps.

Locate the four hole caps included in the accessory pack and install them in the shipping bolt holes.

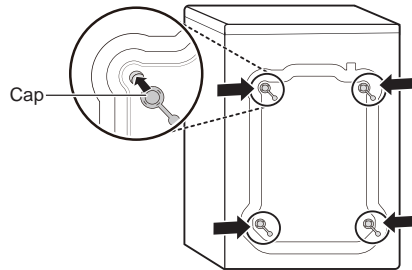

NOTE

- Save the bolt assemblies for future use. To prevent damage to internal components, do not transport the washer without reinstalling the shipping bolts.
- Failure to remove shipping bolts and retainers may cause severe vibration and noise, which can lead to permanent damage to the washer. The cord is secured to the back of the washer with a shipping bolt to help prevent operation with shipping bolts in place.

Connecting the Water Lines

To avoid the risk of costly water damage, purchase and install new inlet hoses when installing the washer.

1 Check the fittings and seals.

Inspect the threaded fitting on each hose and make sure there is a rubber seal in place in both ends of each hose to prevent leaking.

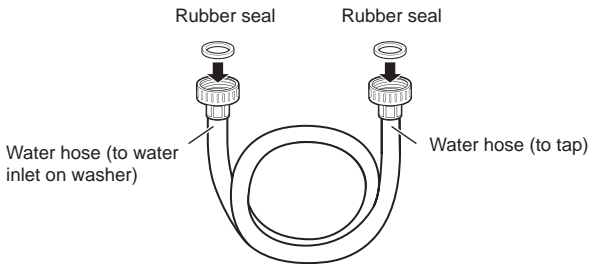

2 Connect the water supply hoses.

Connect the water supply hoses to the hot and cold water faucets tightly by hand and then tighten another 2/3 turn with pliers. Connect the blue hose to a cold water faucet and the red hose to a hot water faucet.

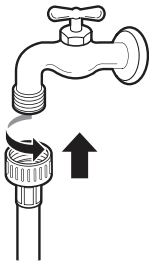

3 Flush out the inlet hoses.

After connecting the inlet hoses to the water faucets, turn on the water faucets to flush out foreign substances (dirt, sand or sawdust) in the water lines. Let water drain into a bucket, and check the water temperature to make sure you've connected the hoses to the correct faucets.

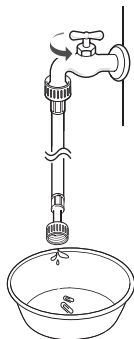

4 Attach the water lines to the back of the washer.

Attach the hot water line to the hot water inlet on the back of the washer. Attach the cold water line to the cold water inlet on the back of the washer. Tighten the fittings securely. Turn ON both faucets all the way and check for leaks at both ends of the hoses.

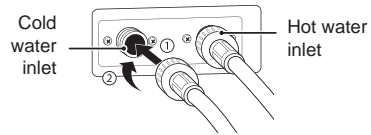

! WARNING

- Do not overtighten the hoses or cross-thread the hose fittings. Overtightening or cross-threading can damage the valves or couplings, resulting in leaking and property damage.
- Do not reuse old hoses. Use only new hoses when installing the washer. Old hoses could leak or burst causing flooding and property damage. Contact an LG Customer Information Center for assistance in buying hoses.

NOTE

- Periodically check the hoses for cracks, leaks, and wear, and replace the hoses every five years. Do not stretch the water hoses intentionally, and make sure that they are not pinched, crushed or kinked by other objects.
- Water supply pressure must be between 20 psi and 120 psi (138 – 827 kPa). If the water supply pressure is more than 120 psi, a pressure reducing valve must be installed.
- To provide optimum washing performance, the hot water temperature should be set at 120 – 130 °F (48 – 54 °C) and the cold at 60 °F (15 °C).
- The washer should never be installed or stored in a location subject to freezing temperatures. Damage to the water lines and internal mechanisms of the washer can result. If the washer was exposed to freezing temperatures prior to installation, allow it to stand at room temperature for several hours before use and check for leaks prior to operation.
- Do not use flood-preventing hoses with auto shutoff devices. The devices can be tripped during fill and prevent the machine from filling properly.

Connecting the Drain Hose

Connect the drain hose to either a standpipe or laundry tub.

NOTE

- The drain hose should always be properly secured. Failure to properly secure the drain hose can result in flooding and property damage.
- The drain must be installed in accordance with any applicable local codes and regulations.
- Make sure that the drain hose is not stretched, pinched, crushed, or kinked.
- Do not install the drain hose with the end lower than 29.5 inches (0.7 m) or higher than 96 inches (2.4 m) above the bottom of the washer or more than 60 inches (1.5 m) away from the washer.
- Never create an airtight seal between the hose and the drain with tape or other means. If no air gap is present, water can be siphoned out of the tub resulting in poor wash/rinse performance or clothing damage.

Option 1: Standpipe

1 Clip the end of the hose into the elbow bracket.

Connect the elbow bracket within 4 inches (10 cm) of the end of the drain hose. If the drain hose is extended more than 4 inches (10 cm) beyond the end of the elbow bracket, mold or microorganisms could spread to the inside of the washer.

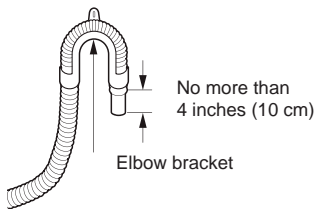

2 Insert the end of the drain hose into the standpipe.

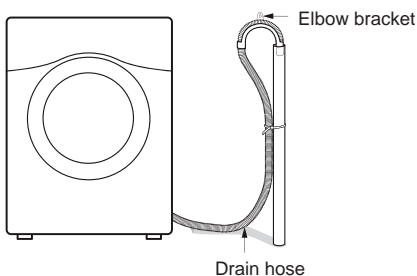

3 Use a tie strap to secure the drain hose in place.

Option 2: Laundry Tub

1 Clip the end of the hose into the elbow bracket.

Connect the elbow bracket within 4 inches (10 cm) of the end of the drain hose. If the drain hose is extended more than 4 inches (10 cm) beyond the end of the elbow bracket, mold or microorganisms could spread to the inside of the washer.

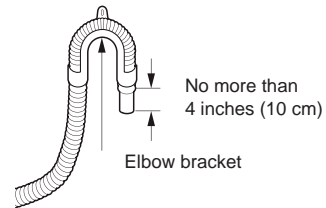

2 Hang the end of the drain hose over the side of the laundry tub.

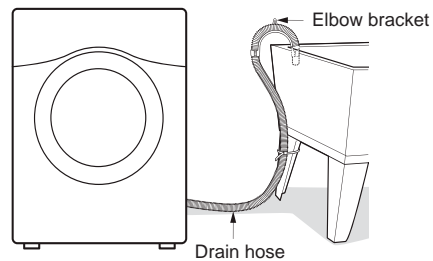

3 Use a tie strap to secure the drain hose in place.

Leveling the Washer

The drum of your new washer spins at very high speeds. To minimize vibration, noise, and unwanted movement, the floor must be a level, solid surface.

NOTE

- Adjust the leveling feet only as far as necessary to level the washer. Extending the leveling feet more than necessary can cause the washer to vibrate.
- Before installing the washer, make sure that the floor is clean, dry and free of dust, dirt, water and oil so the washer feet cannot slide easily. Feet that move or slide on the floor can contribute to excessive vibration and noise due to poor contact with the floor.

1 Position the washer in its final location.

Take special care not to pinch, strain, or crush the water and drain lines. If you have a carpenter's level, you can place it across the top of the washer. The slope beneath the washer should not exceed 1 inch, and all four leveling feet must rest firmly on the floor.

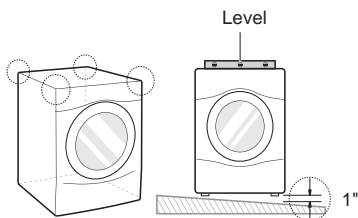

2 Adjust the lower leveling feet.

Turn in one direction to raise the washer or the other direction to lower it.

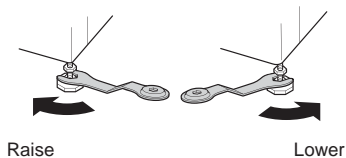

3 Tighten the locknuts.

Turn the locknuts counter-clockwise and tighten them when the washer is level.

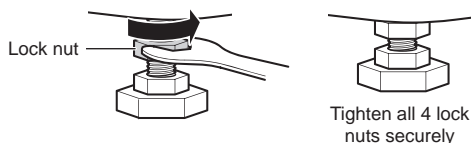

4 Recheck the washer's levelness.

Push or rock the top edges of the washer gently to make sure the washer does not rock. If the washer rocks, repeat steps 1-3.

CAUTION

- Using the washer without leveling it may cause excess vibration and noise, leading to a machine malfunction.
- Extend the leveling feet only to level the washer. If you extend the leveling feet unnecessarily, it may cause abnormal vibration of the washer.

Using Non-Skid Pads

If you install the washer on a slippery surface, it may move because of excessive vibration. Incorrect leveling may cause malfunction through noise and vibration. If this occurs, install the non-skid pads under the leveling feet and adjust the level.

1 Clean the floor to attach the non-skid pads.

Use a dry rag to remove and clean foreign objects or moisture. If moisture remains, the non-skid pads may slip.

2 Adjust the level after placing the washer in the installation area.

3 Place the adhesive side of the non-skid pad on the floor.

It is most effective to install the non-skid pads under the front leveling feet. If it is hard to place the pads under the front leveling feet, place them under the back leveling feet.

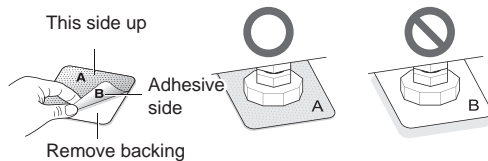

4 Recheck the washer's levelness.

Push or rock the top edges of the washer gently to make sure that the washer does not rock. If the washer rocks, level the washer again.

Connecting to the Power Supply

The washer should be plugged into a 120-VAC, 60 Hz grounded 3-prong outlet. Plug in the washer.

WARNING

- Do not use a worn or damaged power cord or power plug. Replace or repair it immediately. Failure to do so may result in death, fire, electric shock, or malfunction.
- Do not modify the power cord and plug provided with the appliance. Take care not to damage it when installing or moving the washer. Failure to do so may result in death, fire, electric shock, or malfunction.
- Make sure that the washer is grounded.
- Connect this washer to a grounded outlet conforming to the rating prior to use. Failure to do so may result in fire, electric shock, or malfunction.
- Do not damage or cut off the ground prong of the power cord. Doing so may cause death, fire, electric shock, or product malfunction.
- Improper connection of the equipment-grounding conductor can result in risk of electric shock. Check with a qualified electrician or service technician if you are in doubt as to whether the appliance is properly grounded. If it does not fit the outlet, have a proper outlet installed by a qualified electrician
- The appliance and outlet must be positioned so that the plug is easily accessible.
- Do not use adapters or extension cords. Doing so may result in serious injury, fire, electric shock, or death.
- For best performance, plug the washer into its own individual outlet. This helps prevent overloading house wiring circuits which could cause a fire hazard from overheated wires.
- If necessary, use a new, UL-listed 3-prong adapter or 3-wire extension cord with a 3-prong (grounding) plug rated at no less than the branch circuit. Do not use an extension cord longer than 3 feet. Failure to follow these warnings may result in serious injury, fire, electric shock, or death.

Testing the Washer

Check if the washer is properly installed and run a test cycle.

- 1 Load the washer with 6 pounds of laundry (approximately 6 thick bath towels).
- 2 Press the **Power** button.
- 3 Press the **Rinse+Spin** button.
- 4 Press the **Start/Pause** button.
The wash cycle starts.
- 5 Check if water is supplied, that the machine does not rock or vibrate excessively, and that it drains well during the spin cycle.

NOTE

- If water leaks during water supply, see Connecting the Water Lines to connect them properly.
- If the washer rocks and vibrates excessively, see Leveling the Washer to level it again.
- If the drain does not work, see Connecting the Drain Hose to install the hose properly.

OPERATION

Using the Washer

WARNING

- To reduce the risk of fire, electric shock, or injury to persons, read the SAFETY INSTRUCTIONS before operating this appliance.



1 Sort Laundry and Load the Washer

Sort laundry by fabric type, soil level, color and load size, as needed. Open the door and load items into the washer.

If using detergent pods, place pod in drum before loading laundry.



2 Add Cleaning Products.

Add the proper amount of HE (High-Efficiency) detergent to the detergent dispenser. If desired, add bleach or fabric softener to the appropriate areas of the dispenser drawer. Do not place liquid or powdered detergent pods in the dispenser.



3 Turn on the Washer

Press the **Power** button to turn on the washer. The lights above the cycle buttons will illuminate and a chime will sound.



4 Select a Cycle

Turn the Cycle Selector Knob until the desired cycle is selected. The preset Temp., Spin, Soil and option settings for that cycle will be shown. Pressing the **Start/Pause** button without selecting a cycle will cause the Normal cycle to begin immediately.



5 Adjust Settings

Default settings for the selected cycle can now be changed, if desired, using the cycle modifier and option buttons.

- Not all modifiers and options are available on all cycles. A different chime will sound and the LED will not come on if the selection is not allowed.



6 Begin Cycle

Press the **Start/Pause** button to begin the cycle. The washer will agitate briefly without water to measure the weight of the load. If the **Start/Pause** button is not pressed within 60 minutes, the washer will shut off and all settings will be lost.

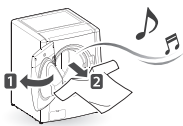

7 End of Cycle

When the cycle is finished, a melody will sound. Immediately remove your clothing from the washer to reduce wrinkling. Check around the door seal when removing the load for small items that may be caught in the seal.

NOTE

- The washer rotates the laundry in a way that allows it to use less water while still fully saturating your clothing. It is normal to not be able to see water during the wash cycle.
- If the temperature or the water level inside the machine is too high, the door will not unlock when the **Start/Pause** button is pressed. To open the door in these circumstances, press **Add Garments**. To stop a cycle and drain the water completely, turn the power off, then on, and then press **Rinse+Spin**.

Loading the Washer

- Check and empty pockets. Paper clips, coins, matches, etc. can damage clothing and the washer.
- Close zippers and hooks, and tie drawstrings to prevent snagging or tangling of clothes.
- Pretreat heavily stained areas for best results.
- Combine large and small items in a load. Load large items first. Large items should not be more than half of total load.
- The washer can be fully loaded, but the drum should not be tightly packed with items. The door of the washer must close easily.
- Do not wash single small items. Add 1-2 similar items to the load to prevent an out-of-balance load.
- Wash thick, bulky items individually. Heavy blankets, comforters, bedspreads, or pet beds can get tangled or cause an unbalanced load if combined with other items.
- Do not wash/spin waterproof items. Washing raincoats or sleeping bags may result in abnormal vibration or may cause the load to bounce, which could damage the drum.
- Wash small, light items in a mesh bag. Items like underwear can get caught in the door seal, and a brassiere hook may damage other items or the drum.
- Brush off heavy soil, dust, and hair from items before washing. Excess dirt or sand can abrade other fabrics and lead to poor wash performance.
- For best performance, load clothes as shown.

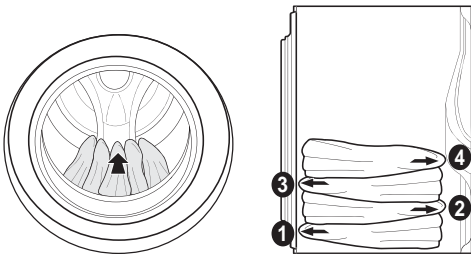

- Load clothes loosely, and do not overfill the drum. Clothes need room to circulate in order to get clean.
- Do not press down on items while stacking them in the drum.

This manual contains an abbreviated Operation section. For the complete Operation section, scan the QR code below or visit: https://us.smarthing.com/images/pdfmanual/VH_FL_VICTOR_899_MFL68005566_EN.pdf

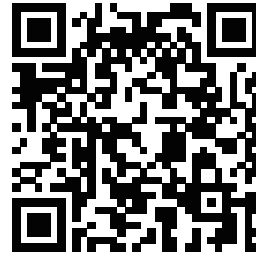

- Sorting Laundry
- Adding Cleaning Products
- Control Panel
- Wash Cycles
- Cycle Guide
- Cycle Modifier Buttons
- Option Buttons

SMART FUNCTIONS

LG SmartThinQ Application

The LG SmartThinQ application allows you to communicate with the appliance using a smartphone.

Before Using LG SmartThinQ

- For appliances with the  or  logo

- 1 Use a smartphone to check the strength of the wireless router (Wi-Fi network) near the appliance.
 - If the distance between the appliance and the wireless router is too far, the signal strength becomes weak. It may take a long time to register or installation may fail.
- 2 Turn off the **Mobile data** or **Cellular Data** on your smartphone.

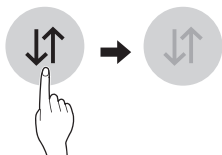

- 3 Connect your smartphone to the wireless router.

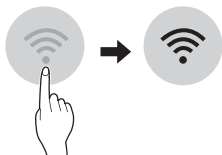

NOTE



- To verify the Wi-Fi connection, check that **Wi-Fi**  icon on the control panel is lit.
- The appliance supports 2.4 GHz Wi-Fi networks only. To check your network frequency, contact your Internet service provider or refer to your wireless router manual.
- LG SmartThinQ is not responsible for any network connection problems or any faults, malfunctions, or errors caused by network connection.
- The surrounding wireless environment can make the wireless network service run slowly.

- If the appliance is having trouble connecting to the Wi-Fi network, it may be too far from the router. Purchase a Wi-Fi repeater (range extender) to improve the Wi-Fi signal strength.
- The network connection may not work properly depending on the Internet service provider.
- The Wi-Fi connection may not connect or may be interrupted because of the home network environment.
- If the appliance cannot be registered due to problems with the wireless signal transmission, unplug the appliance and wait about a minute before trying again.
- If the firewall on your wireless router is enabled, disable the firewall or add an exception to it.
- The wireless network name (SSID) should be a combination of English letters and numbers. (Do not use special characters.)
- Smartphone user interface (UI) may vary depending on the mobile operating system (OS) and the manufacturer.
- If the security protocol of the router is set to **WEP**, network setup may fail. Change the security protocol (**WPA2** is recommended), and register the product again.

Installing the LG SmartThinQ Application

Search for the LG SmartThinQ application from the Google Play Store or Apple App Store on a smart phone. Follow instructions to download and install the application.

LG SmartThinQ Application Features

- For appliances with the  or  logo

Washer Cycle (Remote Start, Downloaded)

Set or download any preferred cycle and operate by remote control.

Tub Clean Coach

This function shows how many cycles remain before it is time to run the Tub Clean cycle.

Smart Diagnosis™

This function provides useful information for diagnosing and solving issues with the appliance based on the pattern of use.

Energy Monitoring

The washer energy usage is affected by the cycles and options so you may see some changes in energy usage from one cycle to another.

Push Alerts

When the cycle is complete or the appliance has problems, you have the option of receiving push notifications on a smart phone.

Settings

Set the product nickname and delete product.

NOTE

- If you change your wireless router, Internet service provider, or password, delete the registered appliance from the LG SmartThinQ application and register it again.
- This information is current at the time of publication. The application is subject to change for product improvement purposes without notice to users.

Using Washer Cycle

Remote Start

Use a smart phone to control the appliance remotely or check to see how much time is left in the cycle.

Using Remote Start

- 1 Press the **Power** button.
- 2 Load the laundry.
- 3 Press and hold **Remote Start** button for 3 seconds to enable the Remote Start function.
- 4 Start a cycle from the LG SmartThinQ application on your smart phone.

NOTE

- Once the Remote Start mode is enabled, you can start a cycle from the LG SmartThinQ smartphone application. If the cycle is not started, the machine will wait to start the cycle until it is turned off remotely from the application or the Remote Start mode is disabled.
- When Remote Start is turned on, the door is automatically locked.

Disabling Remote Start

When the Remote Start is activated, press and hold the **Remote Start** button for 3 seconds.

Downloaded

Download new and specialized cycles that are not included in the standard cycles on the appliance.

Appliances that have been successfully registered can download a variety of specialty cycles specific to the appliance.

Only one cycle can be stored on the appliance at a time.

Once cycle download is completed in the appliance, the appliance keeps the downloaded cycle until a new cycle is downloaded.

Wireless LAN Module Specifications

Model	LCW-004
Frequency Range	2412 - 2462 MHz
Output Power (Max)	IEEE 802.11 b : 22.44 dBm
	IEEE 802.11 g : 24.68 dBm
	IEEE 802.11 n : 24.11 dBm

FCC Notice (For transmitter module contained in this product)

This equipment has been tested and found to comply with the limits for a Class B digital device, pursuant to Part 15 of the FCC Rules. These limits are designed to provide reasonable protection against harmful interference in a residential installation. This equipment generates, uses, and can radiate radio frequency energy and, if not installed and used in accordance with the instructions, may cause harmful interference to radio communications. However, there is no guarantee that interference will not occur in a particular installation. If this equipment does cause harmful interference to radio or television reception, which can be determined by turning the equipment off and on, the user is encouraged to try to correct the interference by one or more of the following measures:

- Reorient or relocate the receiving antenna.
- Increase the separation between the equipment and the receiver.
- Connect the equipment to an outlet on a circuit different from that to which the receiver is connected.
- Consult the dealer or an experienced radio/TV technician for help.

This device complies with part 15 of the FCC Rules. Operation is subject to the following two conditions:

- 1) This device may not cause harmful interference and
- 2) This device must accept any interference received, including interference that may cause undesired operation of the device.

Any changes or modifications in construction of this device which are not expressly approved by the party responsible for compliance could void the user's authority to operate the equipment.

FCC RF Radiation Exposure Statement

This equipment complies with FCC radiation exposure limits set forth for an uncontrolled environment. This transmitter must not be co-located or operating in conjunction with any other antenna or transmitter.

This equipment should be installed and operated with a minimum distance of 20 cm (7.8 inches) between the antenna and your body. Users must follow the specific operating instructions for satisfying RF exposure compliance.

Industry Canada Statement (For transmitter module contained in this product)

This device complies with Industry Canada's applicable licence-exempt RSSs. Operation is subject to the following two conditions:

- 1) This device may not cause interference; and
- 2) This device must accept any interference, including interference that may cause undesired operation of the device.

IC Radiation Exposure Statement

This equipment complies with IC radiation exposure limits set forth for an uncontrolled environment.

This equipment should be installed and operated with a minimum distance of 20 cm (7.8 inches) between the antenna and your body.

NOTE

- THE MANUFACTURER IS NOT RESPONSIBLE FOR ANY RADIO OR TV INTERFERENCE CAUSED BY UNAUTHORIZED MODIFICATIONS TO THIS EQUIPMENT. SUCH MODIFICATIONS COULD VOID THE USER'S AUTHORITY TO OPERATE THE EQUIPMENT.

Open Source Software Notice Information

To obtain the source code under GPL, LGPL, MPL, and other open source licenses, that is contained in this product, please visit <http://opensource.lge.com>. In addition to the source code, all referred license terms, warranty disclaimers and copyright notices are available for download.



LG Electronics will also provide open source code to you on CD-ROM for a charge covering the cost of performing such distribution (such as the cost of media, shipping, and handling) upon email request to opensource@lge.com. This offer is valid for a period of three years after our last shipment of this product. This offer is valid to anyone in receipt of this information.

Smart Diagnosis™ Function

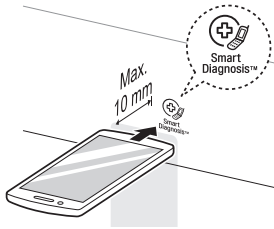
Should you experience any problems with the appliance, it has the capability of transmitting data via your telephone to the LG Customer Information Center. NFC or Wi-Fi equipped models can also transmit data to a smartphone using the LG SmartThinQ application.



Smart Diagnosis™ through the Customer Information Center

- For appliances with the  or  logo



This method allows you to speak directly to our trained specialists. The specialist records the data transmitted from the appliance and uses it to analyze the issue, providing a fast and effective diagnosis.

- 1 Call the LG Electronics Customer Information Center at:
(LG U.S.A.) 1-800-243-0000
(LG Canada) 1-888-542-2623
- 2 When instructed to do so by the call center, place the mouthpiece of the phone close to the Smart Diagnosis™ icon. Do not press any other buttons.
- 3 Press and hold **Temp.** for three seconds.
- 4 Keep the phone in place until the tone transmission has finished.
 - For best results, do not move the phone while the tones are being transmitted.
 - If the call center agent is not able to get an accurate recording of the data, you may be asked to try again.
- 5 Once the countdown is over and the tones have stopped, resume your conversation with the call center agent, who will then be able to assist you using the information transmitted for analysis.

NOTE

- Smart Diagnosis™ cannot be activated unless the appliance can be turned on using the **Power** button. If the appliance cannot be turned on, troubleshooting must be done without using Smart Diagnosis™
- For best results, do not move the phone while the tones are being transmitted.
- If the call center agent is not able to get an accurate recording of the data, you may be asked to try again.
- The Smart Diagnosis™ function depends on the local call quality.
- Bad call quality may result in poor data transmission from your phone to the call center, which could cause Smart Diagnosis™ to malfunction.

LG SmartThinQ Smart Diagnosis™

- For appliances with the  or  logo

Use the Smart Diagnosis feature in the LG SmartThinQ application for help diagnosing issues with the appliance without the assistance of the LG Customer Information Center.

Follow the instructions in the LG SmartThinQ application to perform a Smart Diagnosis using your smartphone.

NOTE

- Smart Diagnosis™ cannot be activated unless the appliance can be turned on using the **Power** button. If the appliance cannot be turned on, troubleshooting must be done without using Smart Diagnosis™

MAINTENANCE

WARNING

To reduce the risk of fire, electric shock, or injury to persons, read this entire owner's manual, including the Important Safety Instructions, before operating this washer.

- Unplug the washer before cleaning to avoid the risk of electric shock. Failure to follow this warning can cause serious injury, fire, electric shock, or death.
- Do not use volatile substances (benzene, paint thinner, alcohol, acetone, etc.), abrasive cleaners, or detergents with strong chemical components when cleaning the washer. Doing so may cause discoloration or damage to the machine, or may cause a fire.
- Certain internal parts are intentionally not grounded and may present a risk of electric shock only during servicing. Service personnel - Do not contact the following parts while the appliance is energized: pump, valve, motor, control board.

Regular Cleaning

Care After Wash

After the cycle is finished, wipe the door and the inside of the door seal to remove any moisture.

- Leave the door open to dry the drum interior.
- Wipe the body of the washer with a dry cloth to remove any moisture.

Cleaning the Exterior

Proper care of your washer can extend its life.

Door:

Wash with a damp cloth on the outside and inside and then dry with a soft cloth.

Exterior:

- Immediately wipe off any spills.
- Wipe with a damp cloth.
- Do not touch the surface or the display with sharp objects.

Care and Cleaning of the Interior

- Use a towel or soft cloth to wipe around the washer door opening and door glass.
- Always remove items from the washer as soon as the cycle is complete. Leaving damp items in the washer can cause wrinkling, color transfer, and odor.
- Run the Tub Clean cycle once a month, or more often if needed, to remove detergent buildup and other residue.

Cleaning the Drum

Over time, residue may build up in the drum, leading to mildew or a musty odor. Run the Tub Clean cycle monthly to remove residue and prevent odor. Run the cycle more often under heavy use conditions or if odor is already present.

- 1 Remove any clothing from the drum.
- 2 Add cleaning agents.

Cleaner	Instructions
Drum cleaner	Add to main detergent compartment of detergent dispenser
Lime scale remover	
Liquid chlorine bleach	Add to bleach compartment of detergent dispenser
Powdered cleaner	Pull out liquid detergent cup before adding to main detergent compartment
Cleaning tablets	Place directly into washer drum

- For other drum cleaning products, follow the cleaner manufacturer's instructions and recommendations.
 - Do not exceed the maximum fill line when adding bleach or powdered cleaners. Powdered detergent may remain in the drum after cleaning.
- 3 Close the door and press the **Power** button to turn the washer on.

- 4 Turn the cycle selector to select the **Tub Clean** cycle.
- 5 Press the **Start/Pause** button to begin the cycle. Selecting any other cycle after Tub Clean has been selected will cause the Tub Clean cycle to be cancelled.
- 6 After the cycle ends, open the door and allow the drum interior to dry completely.

NOTE

- Never load laundry while using Tub Clean. The laundry may be damaged or contaminated with cleaning products. Make sure to run the Tub Clean cycle only when the drum is empty.
- Leave the door open after finishing the laundry, to keep the drum clean.
- Tub Clean should be repeated monthly.
- If mildew or musty smell already exists, run Tub Clean once a week for three consecutive weeks.

Automatic Alert for Tub Clean

When the power is on and the **L L** message blinks on the display, it means the washer drum needs cleaning. Use the Tub Clean cycle to clean the washer drum. The frequency of the automatic alert's appearance depends on how often the washer is used, however the message will generally appear every one to two months.

Removing Mineral Buildup

In areas with hard water, mineral scale can form on internal components of the washer. Periodically clean the mineral buildup on the internal components to extend the lifespan of the washer. Use of a water softener is recommended in areas with hard water.

- Use a descaler, such as Washer Magic®, to remove visible mineral buildup on the washer drum.

After descaling, always run the Tub Clean cycle before washing clothing.

- Mineral scale and other spots may be removed from the stainless steel drum using a soft cloth soaked in stainless steel cleaner.
- Do not use steel wool or abrasive cleaners.

NOTE

- If you use a descaler or tub cleaner during the Tub Clean cycle, use the Rinse+Spin cycle to rinse the washer drum before running your next wash cycle.

Cleaning the Detergent Dispenser Drawer

Leaving detergent in the detergent dispenser drawer for an extended period of time or using the washing machine for a long period of time may cause the build-up of scales in the detergent dispenser drawer. Pull out and clean the detergent dispenser drawer once a week.

- 1 Slide the detergent dispenser drawer out as far as it will go.
- 2 Press down hard on the disengage button and pull out the detergent dispenser drawer.

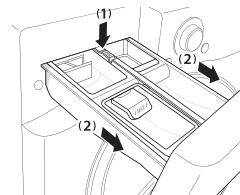

- 3 Remove the inserts from the drawer.
- 4 Clean the inserts with warm water.
 - Use a soft cloth or brush to remove any residue.
 - Use water only when cleaning the drawer and inserts.

- 5 Wipe off any moisture with a dry towel or cloth after cleaning.
- 6 Replace the detergent dispenser drawer.

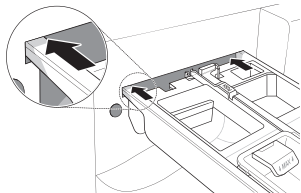

! WARNING

- Do not spray water inside the cabinet. Doing so may cause fire or electric shock.

Cleaning the Door Seal

Clean the door seal once a month to prevent build-up of dirt.

- 1 **Wear rubber gloves and protective goggles.**
- 2 **Dilute 3/4 cup (177 ml) of liquid chlorine bleach in 1 gallon (3.8 L) of water.**
- 3 **Wipe around the door seal.**
Soak a sponge or a soft cloth in this diluted solution and wipe all around the door seal.
- 4 **Wipe dry.**
After cleaning, wipe up any moisture with a dry towel or cloth.
- 5 **Leave the door open to allow the door seal to dry completely.**

! CAUTION

- Cleaning the door seal with undiluted bleach may cause malfunction of the door seal and washer parts. You must add water to the bleach before using it.

Cleaning the Water Inlet Filters

If the washer does not fill properly, an error message will show on the display. The inlet valve filter screens could be plugged by hard water scale, sediment in the water supply, or other debris.

! CAUTION

- The inlet screens protect the delicate parts of the inlet valve from being damaged by particles that could enter the valves with the water supply. Operating the washer with these filters removed could cause a valve to stick open resulting in flooding and/or property damage
- If you use the washer in an area with hard water, the inlet filter may clog due to lime buildup.

- 1 **Turn off both water faucets completely.**
- 2 **Unscrew the hot and cold water hoses from the back of the washer.**
- 3 **Carefully remove the filters from the water valves.**
- 4 **Remove foreign objects and soak the filters in white vinegar or a lime scale remover.**
If using a lime scale remover, follow the manufacturer's instructions. Be careful not to damage the filters while cleaning them.
- 5 **Rinse filters thoroughly and press them back into place.**
- 6 **Flush then reattach the water hoses.**
Before reattaching the hoses, flush the hoses and water lines by running several gallons of water into a bucket or drain, preferably with the faucets wide open for maximum flow.

NOTE

- An **! E** message may blink on the display when the water pressure is weak or an inlet filter is clogged with dirt. Clean the inlet filter.

Cleaning the Drain Pump Filter

The washer fails to drain if the drain pump filter is clogged. Periodically clean the drain filter to prevent clogging with foreign objects.

WARNING

- Opening the drain filter will result in water overflowing if there is water in the washer drum. Use a bucket if the drum is not completely drained before you open the drain filter.
- Using the washer without the drain filter or with an incorrectly assembled drain filter may cause leaks or malfunctioning of the washer.

1 Turn off the machine and unplug it.

2 Open the drain pump filter cover.

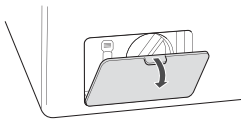

3 Drain any remaining water.

Unclip the drain hose and remove the plug from the drain hose to drain the remaining water.

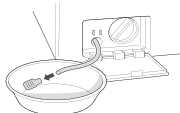

4 Remove the pump filter.

Twist the pump filter counterclockwise to remove.

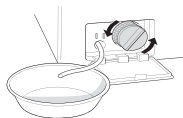

5 Clean the pump filter and opening.

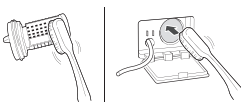

6 Recap the plug onto the drain hose and attach the drain hose.

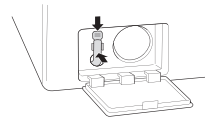

7 Insert the drain pump filter.

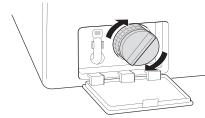

8 Close the drain pump filter cover.

NOTE

- An **DE** message blinks on the display when the drain pump filter is clogged with dirt. Clean the drain pump filter.

Care in Cold Climates

Storing the Washer

If the washer will not be used for an extended period of time and is in an area that could be exposed to freezing temperatures, perform the following steps to protect the washer from damage.

- 1 Turn off the water supply.
- 2 Disconnect the hoses from the water supply and drain any water from the hoses.

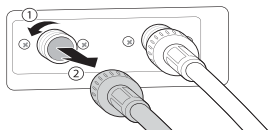

- 3 Plug the power cord into a properly grounded electrical outlet.
- 4 Add 1 gallon of nontoxic recreational vehicle (RV) antifreeze to the empty drum and close the door. Never use automotive antifreeze.
- 5 Press the **Power** button, then select **Spin**.
- 6 Press the **Start/Pause** button to start the drain pump.
- 7 Allow the drain pump to run for one minute, then press the **Power** button to shut off the washer. This will expel some of the antifreeze, leaving enough to protect the washer from damage.
- 8 Unplug the power cord, dry the drum interior with a soft cloth, and close the door.
- 9 Remove the inserts from the dispenser. Drain any water in the compartments and let them dry.
- 10 Store the washer in an upright position.
- 11 To remove the antifreeze from the washer after storage, run a complete Speed Wash cycle using detergent.
 - Do not add laundry to this cycle.

When the Water Line is Frozen

- 1 Turn off the faucets connected to the water lines.
- 2 Pour hot water on the frozen faucets to thaw the water lines and remove them.
- 3 Immerse the water lines in hot water to thaw them.
- 4 Connect the water lines with the water inlets of the washer and with the faucets. See Connecting the Water Lines for details.
- 5 Turn on the faucets.
- 6 Press the **Power** button.
- 7 Press the **Spin** button.
- 8 Press the **Start/Pause** button. Verify the water fills properly.

When the Drain Line is Frozen

- 1 Pour hot water in the washer drum and close the lid. Wait for 1-2 hours.
- 2 Press the **Power** button after thawing.
- 3 Press the **Spin** button to select draining and spinning.
- 4 Press the **Start/Pause** button. Check to make sure the water drains.

TROUBLESHOOTING

FAQs: Frequently Asked Questions

Q: Why does my washer make loud banging noises while it is filling with water?

A: This is actually a problem with the plumbing in your home. When the water valve in the washer shuts off, it can cause pipes in your home to move, resulting in a loud banging noise. This effect, called water hammer, can be reduced by installing an item called a water hammer arrestor. Add-on arrestors can be purchased through your local hardware or home improvement store.

Q: Why is there so little water in my washer? How can it clean the clothes?

A: HE (High-Efficiency) washers are designed to properly wash your laundry while using a minimum amount of water and energy. Because the water volume is low, the small amount of detergent used is more concentrated in the water, resulting in excellent cleaning performance.

Q: When I press a button, why does my washer beep and then nothing happens?

A:

- The Control Lock feature is turned on. To turn off Control Lock, turn the washer on, then press and hold the button that has "Control Lock" on or under it for three seconds.
- Power or Signal is off.

Q: Where should I pour my OxiClean™ or other powdered laundry products when doing my laundry?

A: If you are using powdered laundry detergent, load it in the main detergent dispenser after removing the liquid detergent insert. Powdered laundry agents such as OxiClean™ or powdered color safe bleach should be put directly into the tub. These products can be put in the empty tub before loading or on top of the laundry after loading the machine.

Before Calling for Service

The washer is equipped with an automatic error-monitoring system to detect and diagnose problems at an early stage. If the washer does not function properly or does not function at all, check the following before you call for service.

Noises You Might Hear

Noise	Possible Cause	Solutions
Spraying or Hissing	Water spraying or circulating during the cycle.	• Normal Operation
Humming or Gurgling	Drain pump is pumping water from the washer at times during a cycle.	• Normal Operation
Water sloshing	A liquid in the balance ring around the wash basket helps the basket spin smoothly.	• Normal Operation
Water being added after the washer has already begun to operate	The washer adapts to the load size and type to add more water to the cycle as needed.	• Normal Operation
	The wash load may be unbalanced. If the washer senses that the load is unbalanced, it will stop and refill to redistribute the load.	
	The washer may be diluting laundry additives to add to the wash load.	
Rattling and clanking noise	Foreign objects, such as keys, coins, or safety pins may be in drum or pump.	• Stop washer, check drum and drain filter for foreign objects. If noise continues after washer is restarted, call for service.
Thumping sound	Heavy wash loads may produce a thumping sound.	• This is normal. If sound continues, washer is probably out of balance. Stop and redistribute wash load.
	Wash load may be out of balance.	• Pause the cycle and redistribute the load.
Vibrating noise	Packaging materials were not removed.	• See the Unpacking and Removing Shipping Bolts information in the Installation section.
	Wash load may be unevenly distributed in the drum.	• Pause the cycle and redistribute the load.
	Not all leveling feet are resting firmly and evenly on the floor.	• See Leveling the Washer in the Installation section.
	Floor not rigid enough.	• Make sure that the floor is solid and does not flex. See the Flooring in the Installation section.
Squeaking noise	Packaging materials were not removed.	• See the Unpacking and Removing Shipping Bolts information in the Installation section.
Banging noise when washer is filling with water (Water Hammer)	Plumbing in the home moves or flexes when the water valves in the washer shut off.	• Water hammer is not caused by a defect in the washer. Install water hammer arrestors (purchased separately at hardware or home improvement store) between the fill hose and the washer for best results.
	Household water supply pressure is very high.	• Adjust household water supply regulator to a lower pressure or contact a plumber.

Operation

Problem	Possible Cause	Solutions
Water leaking	Inlet hose connection is loose at faucet or washer.	<ul style="list-style-type: none"> • Check hoses for leaks, cracks and splits. • Check and tighten hose connections.
	House drain pipes are clogged.	<ul style="list-style-type: none"> • The washer pumps out water very rapidly. Check for water backing up out of the drain pipe during drain. If water is seen coming out of the drain, check for proper drain hose installation and check for restrictions in the drain. Contact a plumber to repair drain pipe.
	Drain hose has come out of drain or is not inserted far enough.	<ul style="list-style-type: none"> • Tie drain hose to inlet hose or standpipe to prevent it from coming out during drain. For smaller drain pipes, insert the drain hose into the pipe as far as the drain hose flange. For larger drain pipes, insert the drain hose into the pipe 1-2 inches past the flange.
	A large item such as a pillow or blanket is above the top of the drum.	<ul style="list-style-type: none"> • Use the Bedding cycle for large or bulky items. Use extra care and never wash more than half a load of items that float, such as pillows. • Stop the washer and check the load. Make sure the load does not crest above the top edge of the drum.
	Oversudsing of detergent.	<ul style="list-style-type: none"> • Oversudsing may create leaks, and may be caused by the type and amount of detergent used. High-Efficiency detergent is the only detergent recommended. The normal amount of detergent to use is 1/4 to 1/2 of the maximum amount recommended by the detergent manufacturer.
Water leaks every load	Hoses not installed correctly.	<ul style="list-style-type: none"> • See Connecting the Water Lines to reinstall hoses. Replace damaged hoses.
Washer will not drain water	Kinked drain hose.	<ul style="list-style-type: none"> • Ensure that the drain hose is not kinked.
	Drain located improperly.	<ul style="list-style-type: none"> • Make sure that the drain hose is no more than 5 ft. (1.5 m) away from the washer.
Excessive sudsing	Too much detergent or incorrect detergent.	<ul style="list-style-type: none"> • HE detergents are formulated specifically for High-Efficiency washers and contain suds-reducing agents. Only use detergent with the High-Efficiency (HE) logo.
Washer will not turn on	Power cord is not properly plugged in.	<ul style="list-style-type: none"> • Make sure that the plug is plugged securely into a grounded, 3-prong, 120 VAC, 60 Hz outlet.
	House fuse is blown, circuit breaker has tripped, or power outage has occurred.	<ul style="list-style-type: none"> • Reset circuit breaker or replace fuse. Do not increase fuse capacity. If the problem is a circuit overload, have it corrected by a qualified electrician.

Problem	Possible Cause	Solutions
Wash cycle time is longer than usual	The washer automatically adjusts the wash time for the amount of laundry, water pressure and other operating conditions.	<ul style="list-style-type: none"> This is normal. The washer adjusts cycle time automatically to provide optimal results for the selected cycle. The time remaining shown in the display is only an estimate. Actual time may vary.
Bleach does not dispense	Bleach dispenser cover is not properly installed.	<ul style="list-style-type: none"> Make sure that the bleach cover is properly installed and snapped into place before the beginning of the cycle.
	Bleach dispenser is dirty or clogged.	<ul style="list-style-type: none"> Lift out the bleach dispenser cover and clean out the reservoir. Lint and other foreign debris that collects inside the dispenser may prevent proper dispensing of the bleach.
Premature dispensing of bleach	Bleach dispenser filled for future load.	<ul style="list-style-type: none"> You cannot store bleach in the dispenser for future use. The bleach will be dispensed every load.
Incomplete or no dispensing of detergent	Detergent compartments clogged from incorrect filling.	<ul style="list-style-type: none"> Make sure that detergent and additives are put into the correct dispenser compartments. For all detergent types, always make sure that the dispenser drawer is fully closed before the start of the cycle.
	Too much detergent used.	<ul style="list-style-type: none"> Make sure that the suggested amount of detergent is used per the manufacturer's recommendations. You may also dilute the detergent with water to the maximum fill line on the compartment to avoid clogging. Use only HE (High-Efficiency) detergent. NOTE: Always use as little detergent as possible. High-Efficiency washers need very little detergent to achieve optimum results. Using too much detergent will cause poor wash and rinse performance and may contribute to odors in washer.
	Insufficient water supply.	<ul style="list-style-type: none"> Make sure that both hot and cold water faucets are turned on all the way.
	Normal residue.	<ul style="list-style-type: none"> It is normal for a small amount of detergent to remain in the dispenser. If this residue builds up it can interfere with normal dispensing of products. Refer to the cleaning instructions.
Washer will not operate	Control panel has powered off due to inactivity.	<ul style="list-style-type: none"> This is normal. Press the Power button to turn the washer on.
	Washer is unplugged.	<ul style="list-style-type: none"> Make sure cord is plugged securely into a working outlet.
	Water supply is turned off.	<ul style="list-style-type: none"> Turn both hot and cold faucets fully on.
	Controls are not set properly.	<ul style="list-style-type: none"> Make sure the cycle was set correctly, close the lid and press the Start/Pause button.

Problem	Possible Cause	Solutions
Washer will not operate	Lid is open.	<ul style="list-style-type: none"> • The washer will not operate if the lid is open. Close the lid and make sure that nothing is caught under the lid preventing it from closing completely.
	Circuit breaker/fuse is tripped/blown.	<ul style="list-style-type: none"> • Check house circuit breakers/fuses. Replace fuses or reset breaker. The washer should be on a dedicated branch circuit.
	Control needs to be reset.	<ul style="list-style-type: none"> • Press the Power button, then re-select the desired cycle and press the Start/Pause button.
	Start/Pause was not pressed after a cycle was set.	<ul style="list-style-type: none"> • Press the Power button then re-select the desired cycle and press the Start/Pause button. The washer will shut off if the Start/Pause button is not pressed within 60 minutes.
	Extremely low water pressure.	<ul style="list-style-type: none"> • Check another faucet in the house to make sure that household water pressure is adequate.
	Washer is too cold.	<ul style="list-style-type: none"> • If the washer has been exposed to temperatures below freezing for an extended period of time, allow it to warm up before pressing the Power button. • Otherwise, the display will not come on.
Washer not filling properly	Filter clogged.	<ul style="list-style-type: none"> • Make sure the inlet filters on the fill valves are not clogged. Refer to the filter cleaning instructions.
	Inlet hoses may be kinked.	<ul style="list-style-type: none"> • Check that inlet hoses are not kinked or clogged.
	Energy efficiency.	<ul style="list-style-type: none"> • This is an High-Efficiency (HE) washer. As a result, the water level settings for this washer may be different than for conventional washers.
	Insufficient water supply.	<ul style="list-style-type: none"> • Make sure that both hot and cold water faucets are turned on all the way.
	The washer lid is open.	<ul style="list-style-type: none"> • The washer will not operate if the lid is open. Close the lid and make sure that nothing is caught under the lid preventing it from closing completely.
Water level is too low/ No water is visible in the drum	Energy efficiency	<ul style="list-style-type: none"> • This is an High-Efficiency (HE) washer. As a result, the water level settings for this washer may be different than on your previous washer. The water will not normally cover the clothes. The fill level is optimized for the wash motion to achieve the best wash performance.

Performance





Problem	Possible Cause	Solutions
Wrinkling	Washer not unloaded promptly.	<ul style="list-style-type: none"> Always remove items from the washer as soon as the cycle is complete.
	Washer overloaded.	<ul style="list-style-type: none"> The washer can be fully loaded, but the drum should not be tightly packed with items. The lid of the washer should close easily.
	Hot and cold water inlet hoses are reversed.	<ul style="list-style-type: none"> Hot water rinse can set wrinkles in garments. Check the inlet hose connections.
Staining	Bleach or softener dispensed too soon.	<ul style="list-style-type: none"> Dispenser compartment is overfilled causing bleach or softener to dispense immediately. Always measure bleach to prevent overfilling - one cup maximum. Dispenser drawer closed too quickly causing softener to dispense immediately.
	Bleach or softener was added directly to the wash load in the drum.	<ul style="list-style-type: none"> Always use the dispensers to ensure that laundry products are properly dispensed at the right time in the cycle.
	Washer was not unloaded promptly.	<ul style="list-style-type: none"> Always remove items from the washer as soon as possible after the cycle is complete.
	Clothes were not properly sorted.	<ul style="list-style-type: none"> Always wash dark colors separately from light colors and whites to prevent discoloration. Never wash heavily soiled items with lightly soiled items.
Poor stain removal	Proper options not selected.	<ul style="list-style-type: none"> Heavier soils and tougher stains may require extra cleaning power. Select the Heavy feature to boost the cleaning power of the selected cycle.
	Previously set stains.	<ul style="list-style-type: none"> Articles that have previously been washed may have stains that have been set. These stains may be difficult to remove and may require hand washing or pre-treating to aid in stain removal.
Odor	Some odor is caused by the rubber attached to the washing machine.	<ul style="list-style-type: none"> This odor is normal for new rubber and will disappear after the machine has been run a few times.
	If the rubber door gasket and door seal area are not cleaned regularly, odors can occur from mold or foreign substances.	<ul style="list-style-type: none"> Be sure to clean the gasket and door seal regularly and check under the door seal for small items when unloading the washer.
	Odors can occur if foreign substances are left in the drainage pump filter.	<ul style="list-style-type: none"> Be sure to clean the drainage pump filter regularly.

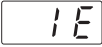

Problem	Possible Cause	Solutions
Odor	Odors can occur if the drainage hose is not properly installed, causing siphoning (water flowing back inside the washing machine).	<ul style="list-style-type: none"> When installing the drainage hose, be sure that it doesn't become kinked or blocked.
	Using the dry function, odors can occur from lint and other laundry matter sticking to the heater. (Dryer model only)	<ul style="list-style-type: none"> This is not a malfunction.
	A particular odor can occur from drying wet clothes with hot air. (Dryer model only)	<ul style="list-style-type: none"> The odor will disappear after a short while.

Wi-Fi

Problem	Possible Cause	Solutions
Trouble connecting appliance and smartphone to Wi-Fi network	The password for the Wi-Fi network was entered incorrectly.	<ul style="list-style-type: none"> Delete your home Wi-Fi network and begin the registration process again.
	Mobile data for your smartphone is turned on.	<ul style="list-style-type: none"> Turn off the Mobile data on your smartphone before registering the appliance.
	The wireless network name (SSID) is set incorrectly.	<ul style="list-style-type: none"> The wireless network name (SSID) should be a combination of English letters and numbers. (Do not use special characters.)
	The router frequency is not 2.4 GHz.	<ul style="list-style-type: none"> Only a 2.4 GHz router frequency is supported. Set the wireless router to 2.4 GHz and connect the appliance to the wireless router. To check the router frequency, check with your Internet service provider or the router manufacturer.
	The distance between the appliance and the router is too far.	<ul style="list-style-type: none"> If the appliance is too far from the router, the signal may be weak and the connection may not be configured correctly. Move the router closer to the appliance or purchase and install a Wi-Fi repeater.

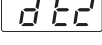
Error Codes

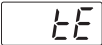
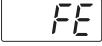
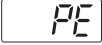
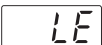
Problem	Possible Cause	Solutions
Washer fills with water slowly or not at all, or 	Water supply faucets are not fully open.	<ul style="list-style-type: none"> • Make sure that the water faucets are fully open.
	Water line hoses are kinked, pinched, or crushed.	<ul style="list-style-type: none"> • Make sure that the hoses are not kinked or pinched. Be careful when moving the washer during cleaning and maintenance.
	Water inlet filters are clogged.	<ul style="list-style-type: none"> • Clean the inlet filters. See the Maintenance section.
	Water supply pressure to faucet or house is too low.	<ul style="list-style-type: none"> • Check another faucet in the house to make sure that household water pressure is adequate and flow is not restricted. Disconnect the inlet hose from the washer and run a few gallons of water through the hose to flush the water supply lines. If flow is too low, contact a plumber to have the water lines repaired.
	Water supply connected with leaklimiting hoses.	<ul style="list-style-type: none"> • Hoses designed to limit leaks can trip falsely and prevent the washer from filling. The use of leaklimiting hoses is not recommended.
	If the balance is not successful, this error will be displayed.	<ul style="list-style-type: none"> • The automatic attempt to rebalance the load was not successful. The cycle has been paused to allow the load to be manually adjusted.
	The load is too small.	<ul style="list-style-type: none"> • Small loads may need additional items to be added to allow the washer to balance the loads.
	Heavy articles are mixed with lighter items.	<ul style="list-style-type: none"> • The load may have heavy items loaded with lighter items. Always try to wash articles of somewhat similar weight to allow the washer to evenly distribute the weight of the load for spinning.
	The load is out of balance.	<ul style="list-style-type: none"> • Manually redistribute the load if articles have become tangled, preventing the automatic distribution from working properly.
The tub does not rotate or   	The door is not secured.	<ul style="list-style-type: none"> • Close and secure the door. If the message keeps appearing, unplug the power cord and call for service.

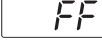
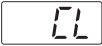
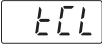
Problem	Possible Cause	Solutions
<p>Water in the washer drains slowly or not at all and</p> 	<p>Drain hose is kinked, pinched, or clogged</p>	<ul style="list-style-type: none"> • Make sure the drain hose is free of clogs or kinks, and is not pinched behind or under the washer.
	<p>Drain discharge is more than 96 inches (2.4 m) above bottom of washer.</p>	<ul style="list-style-type: none"> • The end of the drain hose should be no more than 96 inches (2.4 m) above the bottom of the washer.
	<p>Control error.</p>	<ul style="list-style-type: none"> • Unplug the washer and wait 60 seconds. Reconnect power and try again. If the error reappears, call for service.
	<p>Water level is too high due to a faulty water valve.</p>	<ul style="list-style-type: none"> • Close the water faucets, unplug the washer, and call for service.
	<p>The water level sensor is not working correctly.</p>	<ul style="list-style-type: none"> • Close the water faucets, unplug the washer, and call for service.
	<p>A motor error has occurred.</p>	<ul style="list-style-type: none"> • Allow the washer to stand for 30 minutes and then restart the cycle. If the LE error code persists, call for service.
	<p>If the washing machine detects too many suds, it displays this error code and adds a Suds Reducing cycle. This adds about 2 hours to the cycle time. If too many suds are detected during spinning, the washing machine stops to help prevent leaking.</p>	<ul style="list-style-type: none"> • Do not add more than the manufacturer's recommended amount of detergent.
	<p>The water level too low or high compared to the size of the load.</p>	<ul style="list-style-type: none"> • The water level sensor is not working correctly. Unplug the power cord and call for service.
	<p>Inlet hose, drain hose or drain pump frozen.</p>	<ul style="list-style-type: none"> • See the Care in Cold Climates section for instructions.
	<p>Control Lock is activated.</p>	<ul style="list-style-type: none"> • This is not an error code. This code indicates that the Control Lock is activated. Press and hold Control Lock for 3 seconds.
	<p>Tub Clean is activated or the washer drum needs cleaning.</p>	<ul style="list-style-type: none"> • This is not an error code. This code indicates that the Tub Clean is activated or needed. Use the Tub Clean cycle to clean the washer drum.

LIMITED WARRANTY

FOR USA

ARBITRATION NOTICE: THIS LIMITED WARRANTY CONTAINS AN ARBITRATION PROVISION THAT REQUIRES YOU AND LG TO RESOLVE DISPUTES BY BINDING ARBITRATION INSTEAD OF IN COURT, UNLESS YOU CHOOSE TO OPT OUT. IN ARBITRATION, CLASS ACTIONS AND JURY TRIALS ARE NOT PERMITTED. PLEASE SEE THE SECTION TITLED "PROCEDURE FOR RESOLVING DISPUTES" BELOW.

Should your LG Washer fail due to a defect in materials or workmanship under normal home use, during the warranty period set forth below, LG will at its option repair or replace the product. This limited warranty is valid only to the original retail purchaser of the product and applies only when purchased and used within the United States, including U.S. Territories. Proof of original retail purchase is required to obtain warranty service under this limited warranty.

Warranty Period	Scope of Warranty	Remark
One (1) year from date of original retail purchase	Any internal /functional Parts and Labor	LG will provide parts and labor to repair or replace defective parts.
Ten (10) years from date of original retail purchase	DD Motor (Stator, Rotor, Hall Sensor)	Parts only. Customer will be responsible for any labor or in-home service to replace defective parts.
Limited Lifetime	Stainless Steel Drum	

- Replacement products and parts are warranted for the remaining portion of the original warranty period or ninety (90) days, whichever is greater.
- Replacement products and parts may be new or remanufactured.

THIS WARRANTY IS IN LIEU OF ANY OTHER WARRANTY, EXPRESS OR IMPLIED, INCLUDING WITHOUT LIMITATION, ANY WARRANTY OF MERCHANTABILITY OR FITNESS FOR A PARTICULAR PURPOSE. TO THE EXTENT ANY IMPLIED WARRANTY IS REQUIRED BY LAW, IT IS LIMITED IN DURATION TO THE EXPRESS WARRANTY PERIOD ABOVE. NEITHER THE MANUFACTURER NOR ITS U.S. DISTRIBUTOR SHALL BE LIABLE FOR ANY INCIDENTAL, CONSEQUENTIAL, INDIRECT, SPECIAL, OR PUNITIVE DAMAGES OF ANY NATURE, INCLUDING WITHOUT LIMITATION, LOST REVENUES OR PROFITS, OR ANY OTHER DAMAGE WHETHER BASED IN CONTRACT, TORT, OR OTHERWISE.

Some states do not allow the exclusion or limitation of incidental or consequential damages or limitations on how long an implied warranty lasts, so the above exclusion or limitation may not apply to you. This warranty gives you specific legal rights and you may also have other rights that vary from state to state.

THIS LIMITED WARRANTY DOES NOT COVER:

- Service trips to deliver, pick up, or install or repair the product; instruction to the customer on operation of the product; repair or replacement of fuses or correction of wiring or plumbing, or correction of unauthorized repairs/installation.
- Failure of the product to perform during power failures and interrupted or inadequate electrical service.
- Damage caused by leaky or broken water pipes, frozen water pipes, restricted drain lines, inadequate or interrupted water supply or inadequate supply of air.
- Damage resulting from operating the product in a corrosive atmosphere or contrary to the instructions outlined in the product's owner's manual.
- Damage or failure caused by unauthorized modification or alteration, or if it is used for other than the intended purpose, or any water leakage where the unit was not properly installed.

- Damage or failure caused by incorrect electrical current, voltage, or plumbing codes, commercial or industrial use, or use of accessories, components, or consumable cleaning products that are not approved by LG.
- Damage caused by transportation and handling, including scratches, dents, chips, and/or other damage to the finish of your product, unless such damage results from defects in materials or workmanship and is reported within one (1) week of delivery.
- Damage or missing items to any display, open box, discounted, or refurbished product.
- Products with original serial numbers that have been removed, altered, or cannot be readily determined. Model and serial numbers, along with original retail sales receipts, are required for warranty validation.
- Increases in utility costs and additional utility expenses.
- Repairs when your product is used for other than normal and usual household use (e.g. commercial use, in offices and recreational facilities) or contrary to the instructions outlined in the product's owner's manual.
- Costs associated with removal of your product from your home for repairs.
- The removal and reinstallation of the product if it is installed in an inaccessible location or is not installed in accordance with published installation instructions, including LG's owner's and installation manuals.
- Damage resulting from misuse, abuse, improper installation, repair, or maintenance. Improper repair includes use of parts not approved or specified by LG.

The cost of repair or replacement under these excluded circumstances shall be borne by the consumer.

TO OBTAIN WARRANTY SERVICE AND ADDITIONAL INFORMATION

For additional product information, visit the LG website at <http://www.lg.com>

For assistance using this product or to schedule service, contact LG Electronics at 1-800-243-0000.

For further assistance, write: LG Electronics, 201 James Record Road, Huntsville, Alabama 35813

PROCEDURE FOR RESOLVING DISPUTES:

ALL DISPUTES BETWEEN YOU AND LG ARISING OUT OF OR RELATING IN ANY WAY TO THIS LIMITED WARRANTY OR THE PRODUCT SHALL BE RESOLVED EXCLUSIVELY THROUGH BINDING ARBITRATION, AND NOT IN A COURT OF GENERAL JURISDICTION. BINDING ARBITRATION MEANS THAT YOU AND LG ARE EACH WAIVING THE RIGHT TO A JURY TRIAL AND TO BRING OR PARTICIPATE IN A CLASS ACTION.

Definitions. For the purposes of this section, references to "LG" mean LG Electronics U.S.A., Inc., its parents, subsidiaries and affiliates, and each of their officers, directors, employees, agents, beneficiaries, predecessors in interest, successors, assigns and suppliers; references to "dispute" or "claim" shall include any dispute, claim or controversy of any kind whatsoever (whether based in contract, tort, statute, regulation, ordinance, fraud, misrepresentation or any other legal or equitable theory) arising out of or relating in any way to the sale, condition or performance of the product or this Limited Warranty.

Notice of Dispute. In the event you intend to commence an arbitration proceeding, you must first notify LG in writing at least 30 days in advance of initiating the arbitration by sending a letter to LG at LG Electronics, USA, Inc. Attn: Legal Department- Arbitration 1000 Sylvan Ave, Englewood Cliffs 07632. You and LG agree to engage in good faith discussions in an attempt to amicably resolve your claim. The notice must provide your name, address, and telephone number; identify the product that is the subject of the claim; and describe the nature of the claim and the relief being sought. If you and LG are unable to resolve the dispute within 30 days, either party may proceed to file a claim for arbitration.

Agreement to Binding Arbitration and Class Action Waiver. Upon failure to resolve the dispute during the 30 day period after sending written notice to LG, you and LG agree to resolve any claims between us only by binding arbitration on an individual basis, unless you opt out as provided below. Any dispute between you and LG shall not be combined or consolidated with a dispute involving any other person's or entity's product or claim. More specifically, without limitation of the foregoing, any dispute between you and LG shall not under any circumstances proceed as part of a class or representative action. Instead of arbitration, either party may bring an individual action in small claims court, but that small claims court action may not be brought on a class or representative basis.

Arbitration Rules and Procedures. To begin arbitration of a claim, either you or LG must make a written demand for arbitration. The arbitration will be administered by the American Arbitration Association ("AAA") and will be conducted before a single arbitrator under the AAA's Consumer Arbitration Rules that are in effect at the time the arbitration is initiated (referred to as the "AAA Rules") and under the procedures set forth in this section. The AAA Rules are available online at www.adr.org/consumer. Send a copy of your written demand for arbitration, as well as a copy of this provision, to the AAA in the manner described in the AAA Rules. You must also send a copy of your written demand to LG at LG Electronics, USA, Inc. Attn: Legal Department- Arbitration 1000 Sylvan Avenue Englewood Cliffs, NJ 07632. If there is a conflict between the AAA Rules and the rules set forth in this section, the rules set forth in this section will govern. This arbitration provision is governed by the Federal Arbitration Act. Judgment may be entered on the arbitrator's award in any court of competent jurisdiction. All issues are for the arbitrator to decide, except that issues relating to the scope and enforceability of the arbitration provision and to the arbitrability of the dispute are for the court to decide. The arbitrator is bound by the terms of this provision.

Governing Law. The law of the state of your residence shall govern this Limited Warranty and any disputes between us except to the extent that such law is preempted by or inconsistent with applicable federal law.

Fees/Costs. You do not need to pay any fee to begin an arbitration. Upon receipt of your written demand for arbitration, LG will promptly pay all arbitration filing fees to the AAA unless you seek more than \$25,000 in damages, in which case the payment of these fees will be governed by the AAA Rules. Except as otherwise provided for herein, LG will pay all AAA filing, administration and arbitrator fees for any arbitration initiated in accordance with the AAA Rules and this arbitration provision. If you prevail in the arbitration, LG will pay your attorneys' fees and expenses as long as they are reasonable, by considering factors including, but not limited to, the purchase amount and claim amount. Notwithstanding the foregoing, if applicable law allows for an award of reasonable attorneys' fees and expenses, an arbitrator can award them to the same extent that a court would. If the arbitrator finds either the substance of your claim or the relief sought in the demand is frivolous or brought for an improper purpose (as measured by the standards set forth in Federal Rule of Civil Procedure 11(b)), then the payment of all arbitration fees will be governed by the AAA Rules. In such a situation, you agree to reimburse LG for all monies previously disbursed by it that are otherwise your obligation to pay under the AAA Rules. Except as otherwise provided for, LG waives any rights it may have to seek attorneys' fees and expenses from you if LG prevails in the arbitration.

Hearings and Location. If your claim is for \$25,000 or less, you may choose to have the arbitration conducted solely on the basis of (1) documents submitted to the arbitrator, (2) through a telephonic hearing, or (3) by an in-person hearing as established by the AAA Rules. If your claim exceeds \$25,000, the right to a hearing will be determined by the AAA Rules. Any in-person arbitration hearings will be held at a location within the federal judicial district in which you reside unless we both agree to another location or we agree to a telephonic arbitration.

Opt Out. You may opt out of this dispute resolution procedure. If you opt out, neither you nor LG can require the other to participate in an arbitration proceeding. To opt out, you must send notice to LG no later than 30 calendar days from the date of the first consumer purchaser's purchase of the product by either: (i) sending an e-mail to optout@lge.com, with the subject line: "Arbitration Opt Out" or (ii) calling 1-800-980-2973. You must include in the opt out e-mail or provide by telephone: (a) your name and address; (b) the date on which the product was purchased; (c) the product model name or model number; and (d) the serial number (the serial number can be found (i) on the product; or (ii) online by accessing <https://www.lg.com/us/support/repair-service/schedule-repair-continued> and clicking on "Find My Model & Serial Number").

You may only opt out of the dispute resolution procedure in the manner described above (that is, by e-mail or telephone); no other form of notice will be effective to opt out of this dispute resolution procedure. Opting out of this dispute resolution procedure will not affect the coverage of the Limited Warranty in any way, and you will continue to enjoy the full benefits of the Limited Warranty. If you keep this product and do not opt out, then you accept all terms and conditions of the arbitration provision described above.

FOR CANADA

ARBITRATION NOTICE: THIS LIMITED WARRANTY CONTAINS AN ARBITRATION PROVISION THAT REQUIRES YOU AND LG TO RESOLVE DISPUTES BY BINDING ARBITRATION INSTEAD OF IN COURT, UNLESS THE LAWS OF YOUR PROVINCE OR TERRITORY DO NOT PERMIT THAT, OR, IN OTHER JURISDICTIONS, IF YOU CHOOSE TO OPT OUT. IN ARBITRATION, CLASS ACTIONS AND JURY TRIALS ARE NOT PERMITTED. PLEASE SEE THE SECTION TITLED "PROCEDURE FOR RESOLVING DISPUTES" BELOW.

Should your LG Washer ("Product") fail due to a defect in material or workmanship under normal home use during the warranty period set forth below, LG Canada will at its option repair or replace the product upon receipt of proof of original retail purchase. This warranty is valid only to the original retail purchaser of the product and applies only to a product distributed in Canada by LG Canada or an authorized Canadian distributor thereof. The warranty only applies to Products located and used within Canada.

WARRANTY PERIOD : (Note : If the original date of purchase can not be verified, the warranty will begin sixty(60) days from the date of manufacture).			
Period	One (1) year from date of original retail purchase	Ten (10) years from the date of original retail purchase	Five (5) years from the date of original retail purchase
Scope of Warranty	Parts and Labor (internal/functional parts only)	DD Motor (Stator, Rotor, Hall Sensor)	Stainless Steel Drum
Remark	LG will provide parts & labor to repair or replace defective parts.	Extended Component Warranty (Parts Only) (Consumer will be charged for Labor after one (1) year from the date of purchase)	

Noises associated with normal operation and failure to follow instructions found in the use and care and installation guides or operating the unit in an unsuitable environment will not be covered under this warranty.

- Replacement products and parts are warranted for the remaining portion of the original warranty period or ninety (90) days, whichever is greater.
- Replacement products and parts may be new or remanufactured.
- Proof of original retail purchase specifying the Product model and date of purchase is required to obtain warranty service under this Limited Warranty.

LG CANADA'S SOLE LIABILITY IS LIMITED TO THE WARRANTY SET OUT ABOVE. EXCEPT AS EXPRESSLY PROVIDED ABOVE, LG CANADA MAKES NO AND HEREBY DISCLAIMS ALL OTHER WARRANTIES AND CONDITIONS RESPECTING THE PRODUCT, WHETHER EXPRESS OR IMPLIED, INCLUDING, BUT NOT LIMITED TO, ANY IMPLIED WARRANTY OR CONDITION OF MERCHANTABILITY OR FITNESS FOR A PARTICULAR PURPOSE, AND NO REPRESENTATIONS SHALL BE BINDING ON LG CANADA. LG CANADA DOES NOT AUTHORIZE ANY PERSON TO CREATE OR ASSUME FOR IT ANY OTHER WARRANTY OBLIGATION OR LIABILITY IN CONNECTION WITH THE PRODUCT. TO THE EXTENT THAT ANY WARRANTY OR CONDITION IS IMPLIED BY LAW, IT IS LIMITED TO THE EXPRESS WARRANTY PERIOD ABOVE. LG CANADA, THE MANUFACTURER OR DISTRIBUTOR SHALL NOT BE LIABLE FOR ANY INCIDENTAL, CONSEQUENTIAL, SPECIAL, DIRECT OR INDIRECT DAMAGES, LOSS OF GOODWILL, LOST PROFITS, PUNITIVE OR EXEMPLARY DAMAGES OR ANY OTHER DAMAGE, WHETHER ARISING DIRECTLY OR INDIRECTLY FROM ANY CONTRACTUAL BREACH, FUNDAMENTAL OR OTHERWISE, OR FROM ANY ACTS OR OMISSIONS, TORT, OR OTHERWISE.

This warranty gives you specific legal rights. You may have other rights which may vary from province to province depending on applicable provincial laws. Any term of this warranty that negates or varies any implied condition or warranty under provincial law is severable where it conflicts with provincial law without affecting the remainder of this warranty's terms.

THIS LIMITED WARRANTY DOES NOT COVER:

- Service trips to deliver, pick up, or install the product; instructing a customer on operation of the product; repair or replacement of fuses or correction of wiring or plumbing, or correction of unauthorized repairs/installation.
- Failure of the product to perform during power failures and interruptions or inadequate electrical service.
- Damage caused by leaky or broken water pipes, frozen water pipes, restricted drain lines, inadequate or interrupted water supply or inadequate supply of air.
- Damage resulting from operating the Product in a corrosive atmosphere or contrary to the instructions outlined in the Product owner's manual.
- Damage to the Product caused by accidents, pests and vermin, lightning, wind, fire, floods, or acts of God.
- Damage or product failure caused by unauthorized modification or alteration, or use for other than its intended purpose, or resulting from any water leakage due to improper installation.
- Damage or Product failure caused by incorrect electrical current, voltage, or plumbing codes, commercial or industrial use, or use of accessories, components, or cleaning products that are not approved by LG Canada.
- Damage caused by transportation and handling, including scratches, dents, chips, and/or other damage to the finish of your product, unless such damage results from defects in materials or workmanship and is reported within one (1) week of delivery.
- Damage or missing items to any display, open box, discounted, or refurbished Product.
- Products with original serial numbers that have been removed, altered, or cannot be readily determined. Model and Serial numbers, along with original retail sales receipt, are required for warranty validation.
- Increases in utility costs and additional utility expenses.
- Replacement of light bulbs, filters, or any consumable parts.
- Repairs when your Product is used in other than normal and usual household use (including, without limitation, commercial use, in offices or recreational facilities) or contrary to the instructions outlined in the Product owner's manual.
- Costs associated with removal of the Product from your home for repairs.
- The removal and reinstallation of the Product if it is installed in an inaccessible location or is not installed in accordance with published installation instructions, including the Product owner's and installation manuals.
- Accessories to the Product such as door bins, drawers, handles, shelves, etc.. Also excluded are parts besides those that were originally included with the Product.
- Damage resulting from the misuse, abuse, improper installation, repair, or maintenance of the Product. Improper repair includes use of parts not approved or specified by LG Canada.
- Coverage for "in Home" repairs, for products in-warranty, will be provided if the Product is within a 150 km radius from the nearest authorized service center (ASC), as determined by LG Canada. If your Product is located outside a 150 km radius from a ASC, as determined by LG Canada, it will be your responsibility to bring the Product, at your sole expense, to the ASC for in-warranty repair.

All costs and expenses associated with the above excluded circumstances, listed under the heading, This Limited Warranty Does Not Cover, shall be borne by the consumer.

TO OBTAIN WARRANTY SERVICE AND ADDITIONAL INFORMATION, PLEASE CALL OR VISIT OUR WEBSITE:

Call 1-888-542-2623 (7 A.M. to 12 A.M., 365 days a year) and select the appropriate option from the menu, or visit our website at <http://www.lg.com>

PROCEDURE FOR RESOLVING DISPUTES:

EXCEPT WHERE PROHIBITED AT LAW, ALL DISPUTES BETWEEN YOU AND LG ARISING OUT OF OR RELATING IN ANY WAY TO THIS LIMITED WARRANTY OR THE PRODUCT SHALL BE RESOLVED EXCLUSIVELY THROUGH BINDING ARBITRATION, AND NOT IN A COURT OF GENERAL JURISDICTION. EXCEPT WHERE PROHIBITED AT LAW, YOU AND LG BOTH IRREVOCABLY AGREE TO WAIVE THE RIGHT TO A JURY TRIAL AND TO BRING OR PARTICIPATE IN A CLASS ACTION.

Definitions. For the purposes of this section, references to “LG” mean LG Electronics Canada, Inc., its parents, subsidiaries and affiliates, and each of their officers, directors, employees, agents, beneficiaries, predecessors in interest, successors, assigns and suppliers; references to “dispute” or “claim” shall include any dispute, claim or controversy of any kind whatsoever (whether based in contract, tort, statute, regulation, ordinance, fraud, misrepresentation or any other legal or equitable theory) arising out of or relating in any way to the sale, condition or performance of the product or this Limited Warranty.

Notice of Dispute. In the event you intend to commence an arbitration proceeding, you must first notify LG in writing at least 30 days in advance of initiating the arbitration by sending a letter to LGECI Legal Team at 20 Norelco Drive, North York, Ontario, Canada M9L 2X6 (the “Notice of Dispute”). You and LG agree to engage in good faith discussions in an attempt to amicably resolve your claim. The notice must provide your name, address, and telephone number; identify the product that is the subject of the claim; and describe the nature of the claim and the relief being sought. If you and LG are unable to resolve the dispute within 30 days of LG’s receipt of the Notice of Dispute, the dispute shall be resolved by binding arbitration in accordance with the procedure set out herein. You and LG both agree that, during the arbitration proceeding, the terms (including any amount) of any settlement offer made by either you or LG will not be disclosed to the arbitrator until the arbitrator determines the dispute.

Agreement to Binding Arbitration and Class Action Waiver. Upon failure to resolve the dispute during the 30 day period after LG’s receipt of the Notice of Dispute, you and LG agree to resolve any claims between you and LG only by binding arbitration on an individual basis, unless you opt out as provided below, or you reside in a jurisdiction that prevents full application of this clause in the circumstances of the claims at issue (in which case if you are a consumer, this clause will only apply if you expressly agree to the arbitration). To the extent permitted by applicable law, any dispute between you and LG shall not be combined or consolidated with a dispute involving any other person’s or entity’s product or claim. More specifically, without limitation of the foregoing, except to the extent such a prohibition is not permitted at law, any dispute between you and LG shall not under any circumstances proceed as part of a class or representative action. Instead of arbitration, either party may bring an individual action in small claims court, but that small claims court action may not be brought on a class or representative basis except to the extent this prohibition is not permitted at law in your province or territory of jurisdiction as it relates to the claims at issue between you and LG.

Arbitration Rules and Procedures. To begin arbitration of a claim, either you or LG must make a written demand for arbitration. The arbitration will be private and confidential, and conducted on a simplified and expedited basis before a single arbitrator chosen by the parties under the provincial or territorial commercial arbitration law and rules of the province or territory of your residence. You must also send a copy of your written demand to LG at LG Electronics, Canada, Inc., Attn: Legal Department- Arbitration, 20 Norelco Drive, North York, Ontario M9L 2X6. This arbitration provision is governed by your applicable provincial or territorial commercial arbitration legislation. Judgment may be entered on the arbitrator’s award in any court of competent jurisdiction. All issues are for the arbitrator to decide, except that, issues relating to the scope and enforceability of the arbitration provision and to the arbitrability of the dispute are for the court to decide. The arbitrator is bound by the terms of this provision.

Governing Law. The law of the province or territory of your purchase shall govern this Limited Warranty and any disputes between you and LG except to the extent that such law is preempted by or inconsistent with applicable federal or provincial/territorial law. Should arbitration not be permitted for any claim, action, dispute or controversy between you and LG, you and LG attorn to the exclusive jurisdiction of the courts of the province or territory of your purchase for the resolution of the claim, action, dispute or controversy between you and LG.

Fees/Costs. You do not need to pay any fee to begin an arbitration. Upon receipt of your written demand for arbitration, LG will promptly pay all arbitration filing fees unless you seek more than \$25,000 in damages, in which case the payment of these fees will be governed by the applicable arbitration rules. Except as otherwise provided for herein, LG will pay all filing, administration and arbitrator fees for any arbitration initiated in accordance with the applicable arbitration rules and this arbitration provision. If you prevail in the arbitration, LG will pay your attorneys' fees and expenses as long as they are reasonable, by considering factors including, but not limited to, the purchase amount and claim amount. Notwithstanding the foregoing, if applicable law allows for an award of reasonable attorneys' fees and expenses, an arbitrator can award them to the same extent that a court would. If the arbitrator finds either the substance of your claim or the relief sought in the demand is frivolous or brought for an improper purpose (as measured by the applicable laws), then the payment of all arbitration fees will be governed by the applicable arbitration rules. In such a situation, you agree to reimburse LG for all monies previously disbursed by it that are otherwise your obligation to pay under the applicable arbitration rules. Except as otherwise provided for, LG waives any rights it may have to seek attorneys' fees and expenses from you if LG prevails in the arbitration.

Hearings and Location. If your claim is for \$25,000 or less, you may choose to have the arbitration conducted solely (1) on the basis of documents submitted to the arbitrator, (2) through a telephonic hearing, or (3) by an in-person hearing as established by the applicable arbitration rules. If your claim exceeds \$25,000, the right to a hearing will be determined by the applicable arbitration rules. Any in-person arbitration hearings will be held at the nearest, most mutually-convenient arbitration location available within the province or territory in which you reside unless you and LG both agree to another location or agree to a telephonic arbitration.

Severability and Waiver. If any portion of this Limited Warranty (including these arbitration procedures) is unenforceable, the remaining provisions will continue in full force and effect to the maximum extent permitted by applicable law. Should LG fail to enforce strict performance of any provision of this Limited Warranty (including these arbitration procedures), it does not mean that LG intends to waive or has waived any provision or part of this Limited Warranty.

Opt Out. You may opt out of this dispute resolution procedure. If you opt out, neither you nor LG can require the other to participate in an arbitration proceeding. To opt out, you must send notice to LG no later than 30 calendar days from the date of the first consumer purchaser's purchase of the product by either (i) sending an e-mail to optout@lge.com, with the subject line: "Arbitration Opt Out;" or (ii) calling 1-800-980-2973. You must include in the opt out e-mail or provide by telephone: (a) your name and address; (b) the date on which the product was purchased; (c) the product model name or model number; and (d) the serial number (the serial number can be found (i) on the product; or (ii) online by accessing https://www.lg.com/ca_en/support/repair-service/schedule-repair and clicking on "Find My Model & Serial Number").

In the event that you "Opt Out", the law of the province or territory of your residence shall govern this Limited Warranty and any disputes between you and LG except to the extent that such law is preempted by or inconsistent with applicable federal or provincial/territorial law. Should arbitration not be permitted for any claim, action, dispute or controversy between you and LG, you and LG agree to attorn to the exclusive jurisdiction of the courts of the province or territory of your residence for the resolution of the claim, action, dispute or controversy between you and LG.

You may only opt out of the dispute resolution procedure in the manner described above (that is, by e-mail or telephone); no other form of notice will be effective to opt out of this dispute resolution procedure. Opting out of this dispute resolution procedure will not affect the coverage of the Limited Warranty in any way, and you will continue to enjoy the full benefits of the Limited Warranty. If you keep this product and do not opt out, then you accept all terms and conditions of the arbitration provision described above.

Conflict of Terms. In the event of a conflict or inconsistency between the terms of this Limited Warranty and the End User License Agreement ("EULA") in regards to dispute resolution, the terms of this Limited Warranty shall control and govern the rights and obligations of the parties and shall take precedence over the EULA.

Warranty Exceptions (U.S. and Canada)

Strange vibration or noise caused by not removing shipping bolts or tub support. ➔

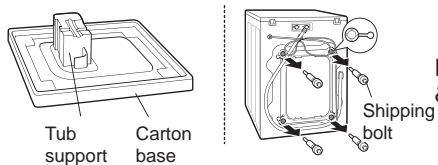

Remove the shipping bolts & tub support.

Leakage caused by dirt (hair, lint) on seal and door glass. ➔



Clean the seal & door glass.

Not draining caused by clogging of pump filter. ➔

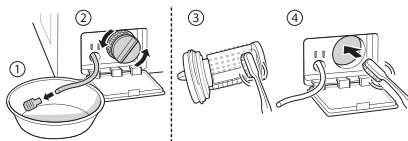

Clean the pump filter.

Water is not supplied because water inlet valve filters are clogged or water inlet hoses are kinked. ➔

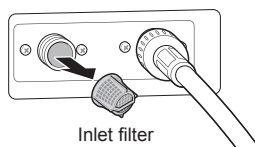

Clean the inlet valve filter or reinstall the water inlet hoses.

Water is not supplied because too much detergent is used. ➔

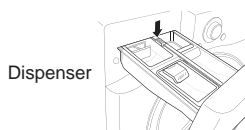

Clean the detergent dispenser drawer.

Laundry is hot or warm after washing because the inlet hoses are installed in reverse. ➔

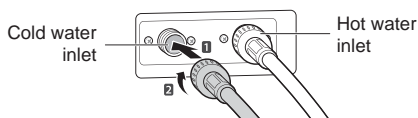

Reinstall the inlet hoses.

Water is not supplied because the water tap is not turned on. ➔

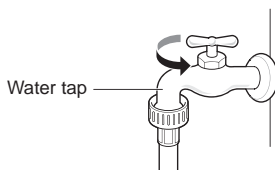

Turn on the water tap.

Leakage caused by improper installation of drain hose or clogged drain hose. ➔

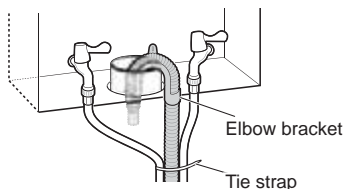

Reinstall the drain hose.

Leakage caused by improper installation of water inlet hose or using non-LG inlet hoses. →

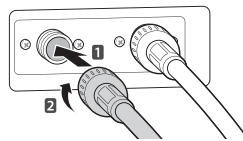

Reinstall the inlet hose.

Power not supplied because of loose connection of power cord or electrical outlet problem. →

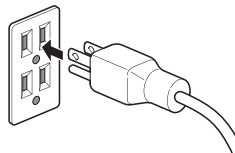

Reconnect the power cord or change the electrical outlet.

Service trips to deliver, pick up, install the product or for instruction on product use. The removal and reinstallation of the Product. →

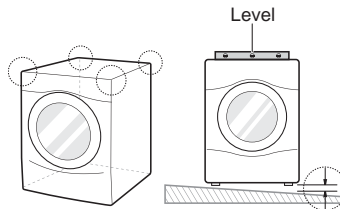

The warranty covers manufacturing defects only. Service resulting from improper Installation is not covered.

If all screws are not installed properly, it may cause excessive vibration (Pedestal model only). →

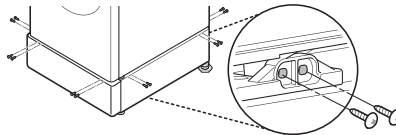

Install 4 screws at each corner (Total 16EA).

Water hammering (banging) noise when washing machine is filling with water. →

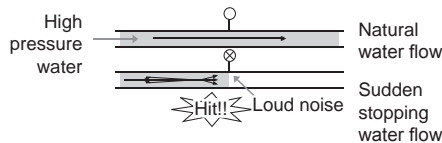

Adjust the water pressure by turning down the water valve or water tap in the home.



LG Customer Information Center

For inquiries or comments,
visit www.lg.com or call:

1-800-243-0000 U.S.A.

1-888-542-2623 CANADA

Register your product Online!

www.lg.com